

IRF7526D1

FETKY™ MOSFET & Schottky Diode

- Co-packaged HEXFET® Power MOSFET and Schottky Diode
- P-Channel HEXFET
- Low V_F Schottky Rectifier
- Generation 5 Technology
- Micro8™ Footprint

Description

The **FETKY™** family of co-packaged HEXFETs and Schottky diodes offer the designer an innovative board space saving solution for switching regulator applications. Generation 5 HEXFETs utilize advanced processing techniques to achieve extremely low on-resistance per silicon area. Combining this technology with International Rectifier's low forward drop Schottky rectifiers results in an extremely efficient device suitable for use in a wide variety of portable electronics applications like cell phone, PDA, etc.

The new Micro8™ package, with half the footprint area of the standard SO-8, provides the smallest footprint available in an SOIC outline. This makes the Micro8™ an ideal device for applications where printed circuit board space is at a premium. The low profile (<1.1mm) of the Micro8™ will allow it to fit easily into extremely thin application environments such as portable electronics and PCMCIA cards.

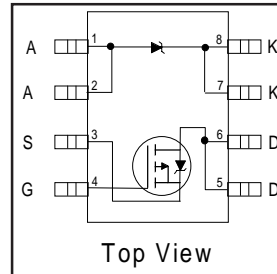

$V_{DSS} = -30V$
$R_{DS(on)} = 0.20\Omega$
Schottky $V_f = 0.39V$

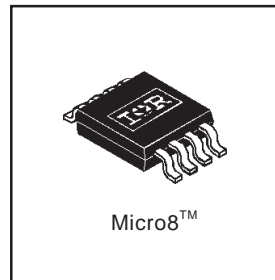

Absolute Maximum Ratings

Parameter	Maximum	Units
$I_D @ T_A = 25^\circ C$	-2.0	A
$I_D @ T_A = 70^\circ C$	-1.6	
I_{DM}	-16	
$P_D @ T_A = 25^\circ C$	1.25	W
$P_D @ T_A = 70^\circ C$	0.8	
Linear Derating Factor	10	mW/°C
V_{GS}	± 20	V
dv/dt	-5.0	V/ns
T_J, T_{STG}	-55 to +150	°C

Thermal Resistance Ratings

Parameter	Maximum	Units
$R_{\theta JA}$	100	°C/W

Notes:

- ① Repetitive rating – pulse width limited by max. junction temperature (see Fig. 9)
- ② $I_{SD} \leq -1.2A$, $di/dt \leq 160A/\mu s$, $V_{DD} \leq V_{(BR)DSS}$, $T_J \leq 150^\circ C$
- ③ Pulse width $\leq 300\mu s$ – duty cycle $\leq 2\%$
- ④ When mounted on 1 inch square copper board to approximate typical multi-layer PCB thermal resistance

MOSFET Electrical Characteristics @ T_J = 25°C (unless otherwise specified)

	Parameter	Min.	Typ.	Max.	Units	Conditions
V _{(BR)DSS}	Drain-to-Source Breakdown Voltage	-30	—	—	V	V _{GS} = 0V, I _D = -250μA
R _{DS(on)}	Static Drain-to-Source On-Resistance	—	0.17	0.20	Ω	V _{GS} = -10V, I _D = -1.2A ③
		—	0.30	0.40		V _{GS} = -4.5V, I _D = -0.60A ③
V _{GS(th)}	Gate Threshold Voltage	-1.0	—	—	V	V _{DS} = V _{GS} , I _D = -250μA
g _{fs}	Forward Transconductance	0.94	—	—	S	V _{DS} = -10V, I _D = -0.60A
I _{DSS}	Drain-to-Source Leakage Current	—	—	-1.0	μA	V _{DS} = -24V, V _{GS} = 0V
		—	—	-25		V _{DS} = -24V, V _{GS} = 0V, T _J = 125°C
I _{GSS}	Gate-to-Source Forward Leakage	—	—	-100	nA	V _{GS} = -20V
	Gate-to-Source Reverse Leakage	—	—	100		V _{GS} = 20V
Q _g	Total Gate Charge	—	7.5	11	nC	I _D = -1.2A
Q _{gs}	Gate-to-Source Charge	—	1.3	1.9		V _{DS} = -24V
Q _{gd}	Gate-to-Drain ("Miller") Charge	—	2.5	3.7		V _{GS} = -10V, See Fig. 6 ③
t _{d(on)}	Turn-On Delay Time	—	9.7	—		V _{DD} = -15V
t _r	Rise Time	—	12	—	ns	I _D = -1.2A
t _{d(off)}	Turn-Off Delay Time	—	19	—		R _G = 6.2Ω
t _f	Fall Time	—	9.3	—		R _D = 12Ω, ③
C _{iss}	Input Capacitance	—	180	—	pF	V _{GS} = 0V
C _{oss}	Output Capacitance	—	87	—		V _{DS} = -25V
C _{rss}	Reverse Transfer Capacitance	—	42	—		f = 1.0MHz, See Fig. 5

MOSFET Source-Drain Ratings and Characteristics

	Parameter	Min.	Typ.	Max.	Units	Conditions
I _S	Continuous Source Current (Body Diode)	—	—	-1.25	A	
I _{SM}	Pulsed Source Current (Body Diode)	—	—	-9.6		
V _{SD}	Body Diode Forward Voltage	—	—	-1.2	V	T _J = 25°C, I _S = -1.2A, V _{GS} = 0V
t _{rr}	Reverse Recovery Time (Body Diode)	—	30	45	ns	T _J = 25°C, I _F = -1.2A
Q _{rr}	Reverse Recovery Charge	—	37	55	nC	di/dt = 100A/μs ③

Schottky Diode Maximum Ratings

	Parameter	Max.	Units	Conditions
I _{F(av)}	Max. Average Forward Current	1.9	A	50% Duty Cycle. Rectangular Wave, T _A = 25°C See Fig. 14 T _A = 70°C
		1.3		
I _{SM}	Max. peak one cycle Non-repetitive Surge current	120	A	Following any rated load condition & with V _{RRM} applied
		11		

Schottky Diode Electrical Specifications

	Parameter	Max.	Units	Conditions
V _{FM}	Max. Forward voltage drop	0.50	V	I _F = 1.0A, T _J = 25°C
		0.62		I _F = 2.0A, T _J = 25°C
		0.39		I _F = 1.0A, T _J = 125°C
		0.57		I _F = 2.0A, T _J = 125°C.
I _{RM}	Max. Reverse Leakage current	0.06	mA	V _R = 30V, T _J = 25°C
		16		T _J = 125°C
C _t	Max. Junction Capacitance	92	pF	V _R = 5Vdc (100kHz to 1 MHz) 25°C
dv/dt	Max. Voltage Rate of Charge	3600	V/μs	Rated V _R

(HEXFET is the reg. TM for International Rectifier Power MOSFET's)

Power Mosfet Characteristics

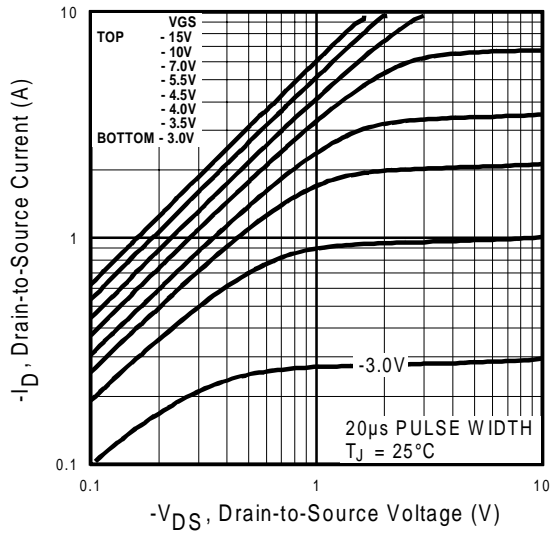

Fig 1. Typical Output Characteristics

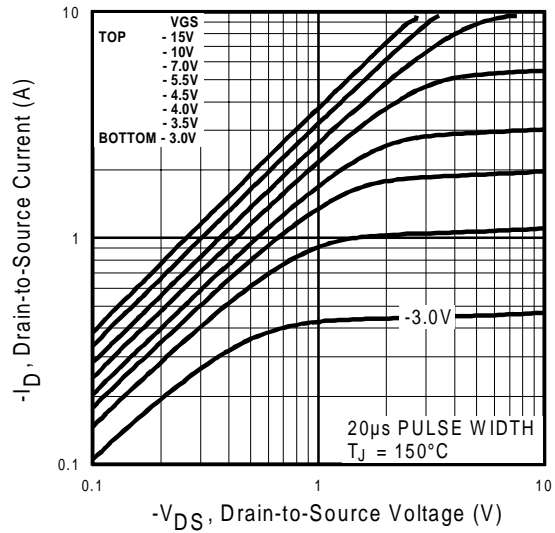

Fig 2. Typical Output Characteristics

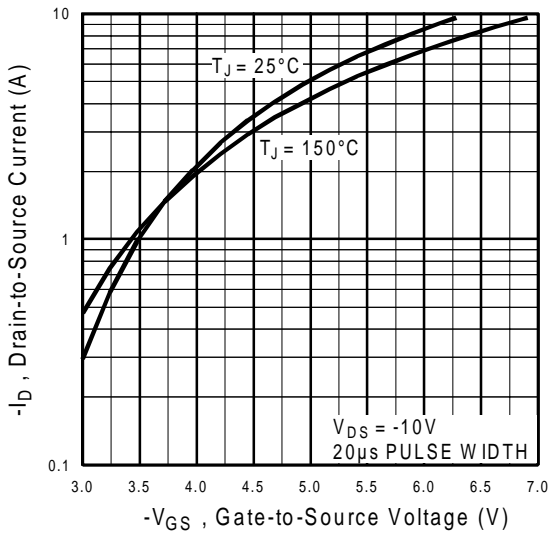

Fig 3. Typical Transfer Characteristics

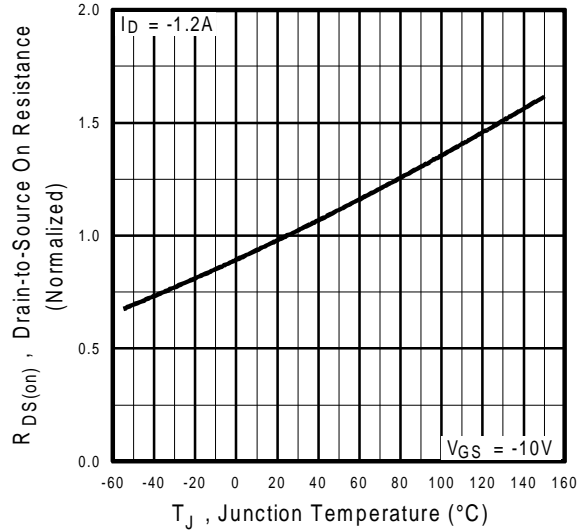

Fig 4. Normalized On-Resistance Vs. Temperature

Power Mosfet Characteristics

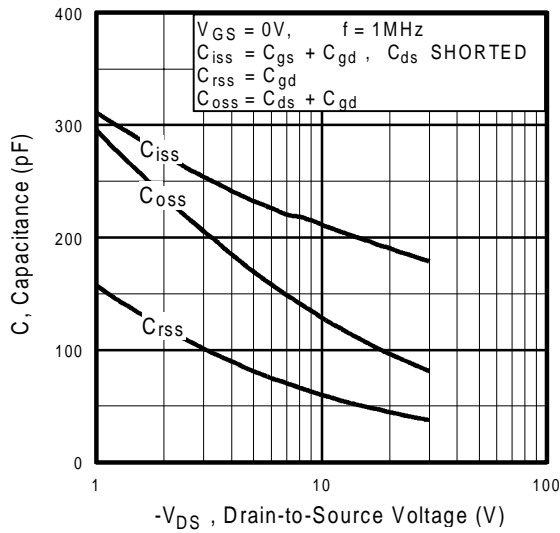

Fig 5. Typical Capacitance Vs. Drain-to-Source Voltage

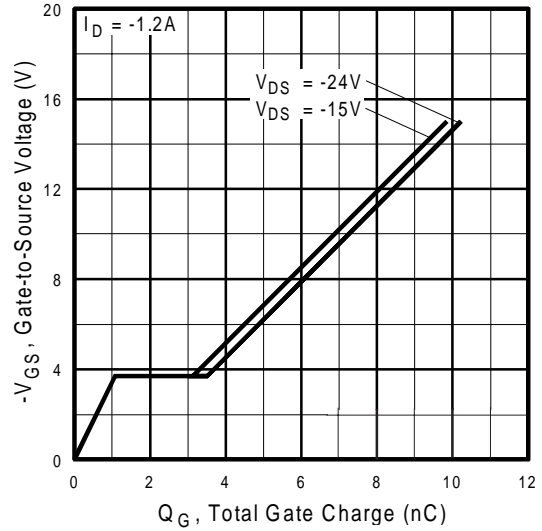

Fig 6. Typical Gate Charge Vs. Gate-to-Source Voltage

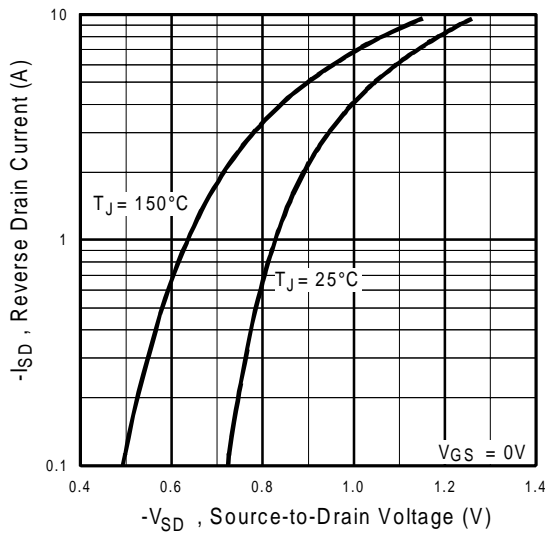

Fig 7. Typical Source-Drain Diode Forward Voltage

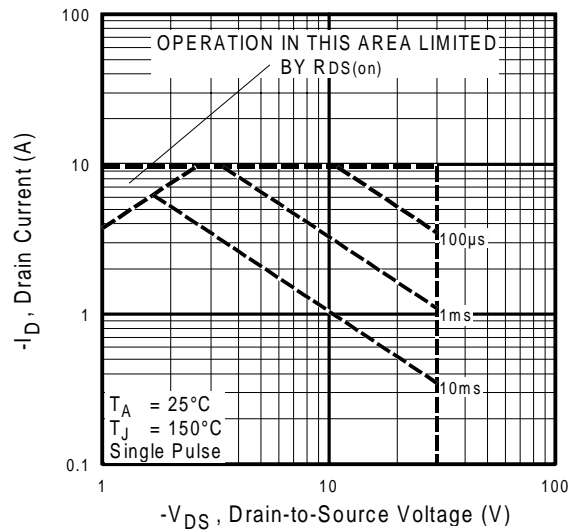

Fig 8. Maximum Safe Operating Area

Power Mosfet Characteristics

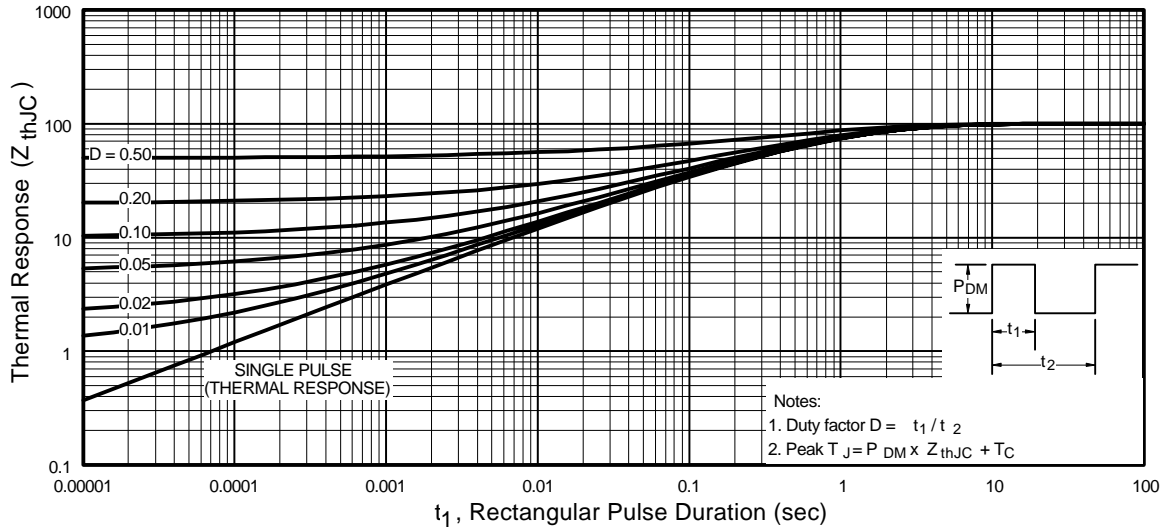

Fig 9. Maximum Effective Transient Thermal Impedance, Junction-to-Ambient

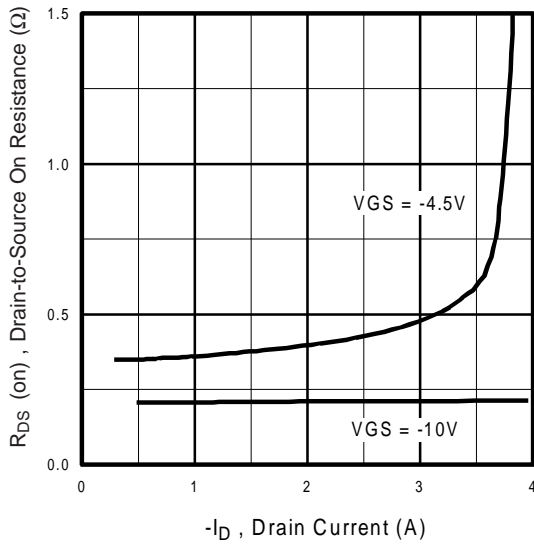

Fig 10. Typical On-Resistance Vs. Drain Current

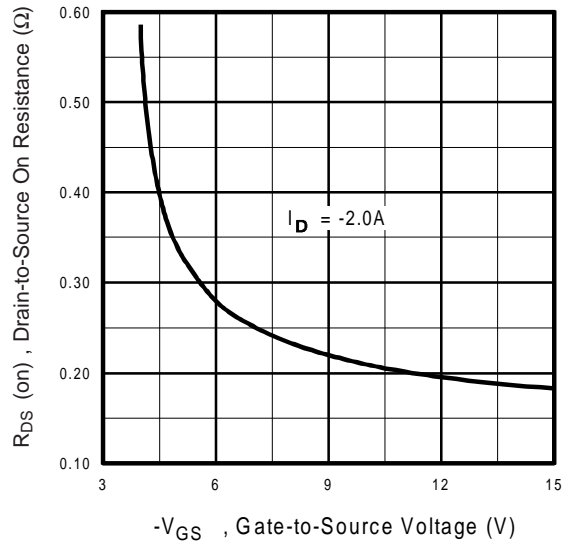

Fig 11. Typical On-Resistance Vs. Gate Voltage

Schottky Diode Characteristics

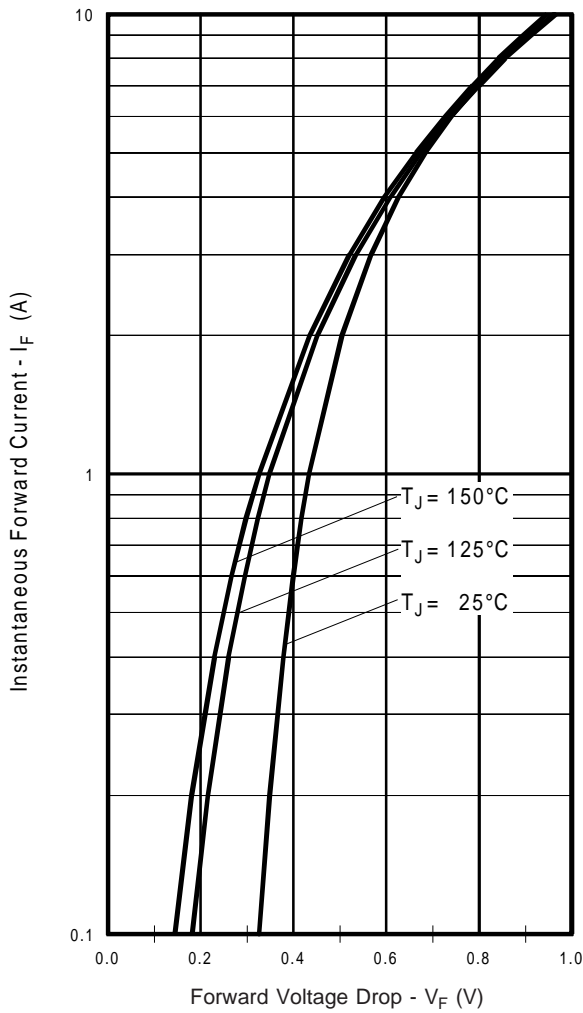

Fig. 12 -Typical Forward Voltage Drop Characteristics

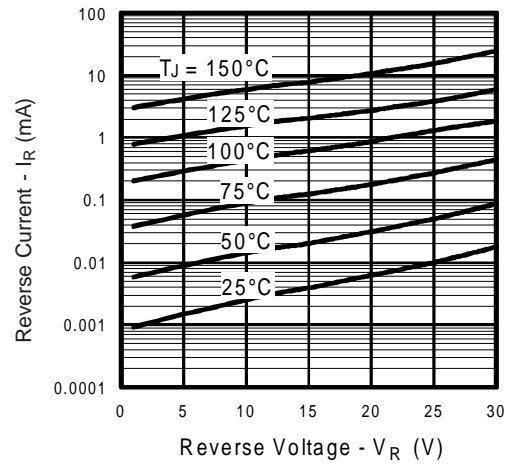

Fig. 13 - Typical Values of Reverse Current Vs. Reverse Voltage

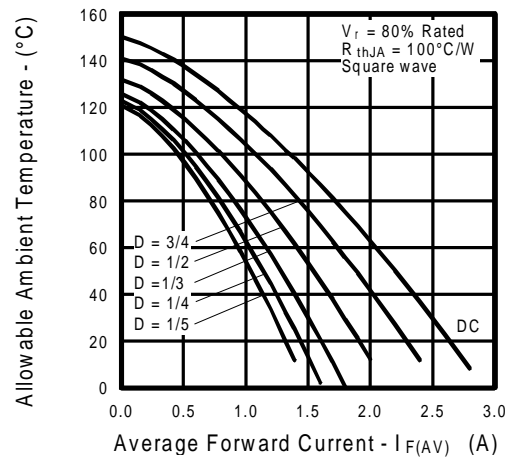
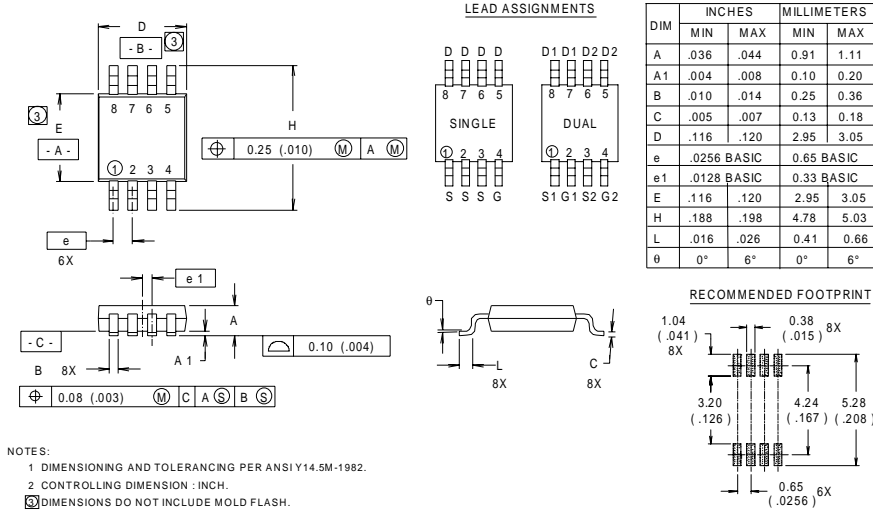

Fig.14 - Maximum Allowable Ambient Temp. Vs. Forward Current

International
IRF Rectifier
Micro8™ Package Details

IRF7526D1



Part Marking

EXAMPLE: THIS IS AN IRF7501

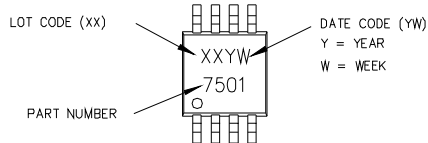

WW = (1-26) IF PRECEDED BY LAST DIGIT OF CALENDAR YEAR

DATE CODE EXAMPLES:
 YWW = 9503 = 5C
 YWW = 9532 = EF

YEAR	Y	WORK WEEK	W
2001	1	01	A
2002	2	02	B
2003	3	03	C
1994	4	04	D
1995	5		
1996	6		
1997	7		
1998	8		
1999	9		
2000	D	24	X
		25	Y
		26	Z

WW = (27-52) IF PRECEDED BY A LETTER

YEAR	Y	WORK WEEK	W
2001	A	27	A
2002	B	28	B
2003	C	29	C
1994	D	30	D
1995	E		
1996	F		
1997	G		
1998	H		
1999	J		
2000	K	50	X
		51	Y
		52	Z

IRF7526D1

International
IR Rectifier

Micro8™ Tape & Reel

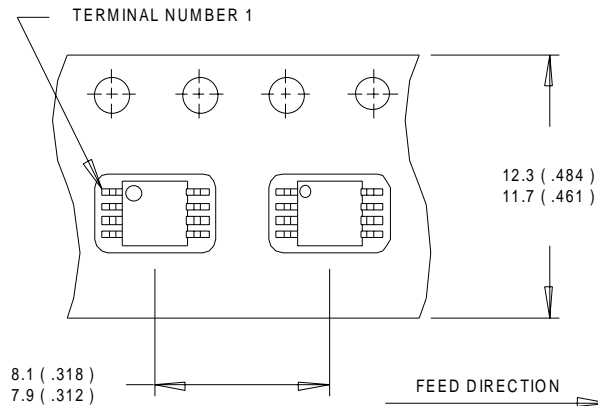

- NOTES:
1. OUTLINE CONFORMS TO EIA-481 & EIA-541.
 2. CONTROLLING DIMENSION : MILLIMETER.

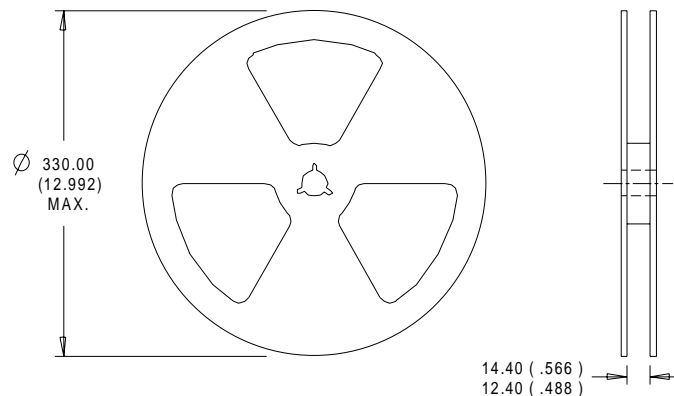

- NOTES :
1. CONTROLLING DIMENSION : MILLIMETER.
 2. OUTLINE CONFORMS TO EIA-481 & EIA-541.

International
IR Rectifier

WORLD HEADQUARTERS: 233 Kansas St., El Segundo, California 90245, Tel: (310) 322 3331

IR GREAT BRITAIN: Hurst Green, Oxted, Surrey RH8 9BB, UK Tel: ++ 44 1883 732020

IR CANADA: 15 Lincoln Court, Brampton, Ontario L6T3Z2, Tel: (905) 453 2200

IR GERMANY: Saalburgstrasse 157, 61350 Bad Homburg Tel: ++ 49 6172 96590

IR ITALY: Via Liguria 49, 10071 Borgaro, Torino Tel: ++ 39 11 451 0111

IR FAR EAST: K&H Bldg., 2F, 30-4 Nishi-Ikebukuro 3-Chome, Toshima-Ku, Tokyo Japan 171 Tel: 81 3 3983 0086

IR SOUTHEAST ASIA: 1 Kim Seng Promenade, Great World City West Tower, 13-11, Singapore 237994 Tel: ++ 65 221 8371

IR TAIWAN: 16 Fl. Suite D. 207, Sec. 2, Tun Haw South Road, Taipei, 10673, Taiwan Tel: 886-2-2377-9936

<http://www.irf.com/> Data and specifications subject to change without notice . 5/99