



## 100 Hz to 50 kHz Fixed Frequency

## DIP Filters 8-, 6-, 4-Pole Filters

### Description

The D70 Series of small, fixed-frequency, linear active DIP filters provide high performance linear, multi-pole filtering in a compact package, with a broad range of pole configurations. These Butterworth and Bessel low-pass and Butterworth high-pass filters combine the excellent performance of linear multi-pole filter design with the space saving of the dual in-line package (DIP). Each model comes factory tuned to a user-specified corner frequency between 100Hz and 50kHz. These fully self-contained units require no external components or adjustments. They operate with dynamic input voltage range from non-critical  $\pm 5V$  to  $\pm 18V$  power supplies.

### Features/Benefits:

- Compact DIP design minimizes board space requirements
- Plug-in ready-to-use, reducing engineering design and manufacturing time
- Factory tuned, no external clocks or adjustments needed
- Low harmonic distortion and wide signal-to-noise ratio to 14 bit resolution
- Broad range of pole configurations and corner frequencies to meet a wide range of applications

### Applications

- Anti-alias filtering
- Data acquisition systems
- Communication systems and electronics
- Medical electronics equipment and research
- Aerospace, navigation and sonar applications
- Sound and vibration testing
- Real and compressed time data analysis
- Noise elimination
- Signal reconstruction



### Available Low-Pass Models:

	<b>Page</b>
<b>D70L8B</b> 8-pole Butterworth . . . . .	.2
<b>D70L6B</b> 6-pole Butterworth . . . . .	.2
<b>D70L4B</b> 4-pole Butterworth . . . . .	.2
<b>D70L8L</b> 8-pole Bessel . . . . .	.3
<b>D70L6L</b> 6-pole Bessel . . . . .	.3
<b>D70L4L</b> 4-pole Bessel . . . . .	.3

### Available High-Pass Models:

<b>D70H8B</b> 8-pole Butterworth . . . . .	.4
<b>D70H6B</b> 6-pole Butterworth . . . . .	.4
<b>D70H4B</b> 4-pole Butterworth . . . . .	.4

### General Specifications:

Pin-out/package data & ordering information . . . .5



### Fixed Frequency

Model	D70L8B	D70L6B	D70L4B
<b>Product Specifications</b>			
<b>Transfer Function</b>	8-Pole, Butterworth	6-Pole, Butterworth	4-Pole, Butterworth,
<b>Size</b>	0.84" x 0.65" x 0.31"	0.84" x 0.65" x 0.31"	0.65" x 0.51" x 0.31"
<b>Range <math>f_c</math></b>	100 Hz to 50 kHz	100 Hz to 50 kHz	100 Hz to 50 kHz
<b>Theoretical Transfer Characteristics</b>	Appendix A Page 9	Appendix A Page 8	Appendix A Page 7
<b>Passband Ripple</b> (theoretical)	0.0 dB	0.0 dB	0.0 dB
<b>DC Voltage Gain</b> (non-inverting)	0 ± 0.02 dB typ.	0 ± 0.02 dB typ.	0 ± 0.02 dB typ.
<b>Stopband Attenuation Rate</b>	48 dB/octave	36 dB/octave	24 dB/octave
<b>Cutoff Frequency Stability</b> <b>Amplitude</b> <b>Phase</b>	$f_c$ ± 2% max. ± 0.02% /°C -3 dB -360°	$f_c$ ± 2% max. ± 0.02% /°C -3 dB -270°	$f_c$ ± 2% max. ± 0.02% /°C -3 dB -180°
<b>Filter Attenuation</b> (theoretical)	0.12 dB      0.80 $f_c$ 3.01 dB      1.00 $f_c$ 60.0 dB      2.37 $f_c$ 80.0 dB      3.16 $f_c$	0.29 dB      0.80 $f_c$ 3.01 dB      1.00 $f_c$ 60.0 dB      3.16 $f_c$ 80.0 dB      4.64 $f_c$	0.67 dB      0.80 $f_c$ 3.01 dB      1.00 $f_c$ 60.0 dB      5.62 $f_c$ 80.0 dB      10.0 $f_c$
<b>Phase Match<sup>1</sup></b>			
<b>Amplitude Accuracy<sup>1</sup></b> (theoretical)			
<b>Total Harmonic Distortion @ 1 kHz</b>	< -90 dB	< -90 dB	< -90 dB
<b>Wide Band Noise</b> (20 Hz - 4 MHz)	200 $\mu$ Vrms typ.	200 $\mu$ Vrms typ.	200 $\mu$ Vrms typ.
<b>Narrow Band Noise</b> (5 Hz - 50 kHz)	50 $\mu$ Vrms typ.	50 $\mu$ Vrms typ.	50 $\mu$ Vrms typ.
<b>Filter Mounting Assembly</b>	FMA-01A	FMA-01A	FMA-01A

1. Phase Match and Amplitude Accuracy are within ±2% max., ±1% typ. of the theoretical transfer characteristics.



## Fixed Frequency

## 8-, 6-, 4-Pole Low-Pass Filters

Model	D70L8L	D70L6L	D70L4L	
<b>Product Specifications</b>				
<b>Transfer Function</b>	8-Pole, Bessel	6-Pole, Bessel	4-Pole, Bessel	
<b>Size</b>	0.84" x 0.65" x 0.31"	0.84" x 0.65" x 0.31"	0.65" x 0.51" x 0.31"	
<b>Range <math>f_c</math></b>	100 Hz to 50 kHz	100 Hz to 50 kHz	100 Hz to 50 kHz	
<b>Theoretical Transfer Characteristics</b>	Appendix A Page 4	Appendix A Page 3	Appendix A Page 2	
<b>Passband Ripple</b> (theoretical)	0.0 dB	0.0 dB	0.0 dB	
<b>DC Voltage Gain</b> (non-inverting)	0 ± 0.02 dB typ.	0 ± 0.02 dB typ.	0 ± 0.02 dB typ.	
<b>Stopband Attenuation Rate</b>	48 dB/octave	36 dB/octave	24 dB/octave	
<b>Cutoff Frequency Stability</b> <b>Amplitude</b> <b>Phase</b>	$f_c$ ± 2% max. ± 0.02% /°C -3 dB -182°	$f_c$ ± 2% max. ± 0.02% /°C -3 dB -155°	$f_c$ ± 2% max. ± 0.02% /°C -3 dB -121°	
<b>Filter Attenuation</b> (theoretical)	1.91 dB      0.80 $f_c$ 3.01 dB      1.00 $f_c$ 60.0 dB      4.52 $f_c$ 80.0 dB      6.07 $f_c$	1.89 dB      0.80 $f_c$ 3.01 dB      1.00 $f_c$ 60.0 dB      5.41 $f_c$ 80.0 dB      7.99 $f_c$	1.86 dB      0.80 $f_c$ 3.01 dB      1.00 $f_c$ 60.0 dB      8.48 $f_c$ 80.0 dB      15.12 $f_c$	
<b>Phase Match<sup>1</sup></b>				
<b>Amplitude Accuracy<sup>1</sup></b> (theoretical)				
<b>Total Harmonic Distortion @ 1 kHz</b>	< -90 dB	< -90 dB	< -90 dB	
<b>Wide Band Noise</b>	200 $\mu$ Vrms typ.	200 $\mu$ Vrms typ.	200 $\mu$ Vrms typ.	
<b>Narrow Band Noise</b>	50 $\mu$ Vrms typ.	50 $\mu$ Vrms typ.	50 $\mu$ Vrms typ.	
<b>Filter Mounting Assembly</b>	FMA-01A	FMA-01A	FMA-01A	

1. Phase Match and Amplitude Accuracy are within ±2% max., ±1% typ. of the theoretical transfer characteristics.



### Fixed Frequency

Model	D70H8B	D70H6B	D70H4B	
<b>Product Specifications</b>				
<b>Transfer Function</b>	8-Pole, Butterworth	6-Pole, Butterworth	4-Pole, Butterworth	
<b>Size</b>	0.84" x 0.65" x 0.31"	0.84" x 0.65" x 0.31"	0.65" x 0.51" x 0.31"	
<b>Range <math>f_c</math></b>	100 Hz to 50 kHz	100 Hz to 50 kHz	100 Hz to 50 kHz	
<b>Theoretical Transfer Characteristics</b>	Appendix A Page 29	Appendix A Page 28	Appendix A Page 27	
<b>Passband Ripple</b> (theoretical)	0.0 dB	0.0 dB	0.0 dB	
<b>Voltage Gain</b> (non-inverting)	0 ± 0.02 dB typ.	0 ± 0.02 dB typ.	0 ± 0.02 dB typ.	
<b>Power Bandwidth</b>	120 kHz	120 kHz	120 kHz	
<b>Small Signal Bandwidth</b>	(-6dB) 1 MHz	(-6dB) 1 MHz	(-6dB) 1 MHz	
<b>Stopband Attenuation Rate</b>	48 dB/octave	36 dB/octave	24 dB/octave	
<b>Cutoff Frequency Stability</b> <b>Amplitude</b> <b>Phase</b>	$f_c$ ± 2% max. ± 0.02% /°C -3 dB -360°	$f_c$ ± 2% max. ± 0.02% /°C -3 dB -270°	$f_c$ ± 2% max. ± 0.02% /°C -3 dB -180°	
<b>Filter Attenuation</b> (theoretical)	80 dB      0.31 $f_c$ 60 dB      0.42 $f_c$ 3.01 dB    1.00 $f_c$ 00.0 dB    2.00 $f_c$	80 dB      0.21 $f_c$ 60 dB      0.32 $f_c$ 3.01 dB    1.00 $f_c$ 00.0 dB    2.50 $f_c$	80 dB      0.10 $f_c$ 60 dB      0.18 $f_c$ 3.01 dB    1.00 $f_c$ 00.0 dB    4.0 $f_c$	
<b>Phase Match<sup>1</sup></b>				
<b>Amplitude Accuracy<sup>1</sup></b> (theoretical)				
<b>Total Harmonic Distortion @ 1 kHz</b>	< -80 dB	< -80 dB	< -80 dB	
<b>Wide Band Noise</b> (20 Hz - 4 MHz)	400 $\mu$ Vrms typ.	400 $\mu$ Vrms typ.	400 $\mu$ Vrms typ.	
<b>Narrow Band Noise</b> (20 Hz - 100 kHz)	100 $\mu$ Vrms typ.	100 $\mu$ Vrms typ.	100 $\mu$ Vrms typ.	
<b>Filter Mounting Assembly</b>	FMA-01A	FMA-01A	FMA-01A	

1. Phase Match and Amplitude Accuracy are within ±2% max., ±1% typ. of the theoretical transfer characteristics.



## Specification

(25°C and  $V_s \pm 15$  Vdc)

## Pin-Out and Package Data Ordering Information

### Analog Input Characteristics<sup>1</sup>

Impedance	10 k $\Omega$ min.
Voltage Range	$\pm 10$ V <sub>peak</sub>
Max. Safe Voltage	$\pm V_s$

### Analog Output Characteristics

Impedance	1 $\Omega$
Linear Operating Range	$\pm 10$ V
Maximum Current <sup>2</sup>	$\pm 10$ mA
Offset Voltage <sup>3</sup>	$\pm 10$ mV
Offset Temp. Coeff.	50 $\mu$ V /°C

### Power Supply ( $\pm V_s$ )

Rated Voltage	$\pm 15$ Vdc
Operating Range	$\pm 5$ to $\pm 18$ Vdc
Maximum Safe Voltage	$\pm 18$ Vdc
Quiescent Current (max.)	
8 Pole	$\pm 18$ mA
6 Pole	$\pm 15$ mA
4 Pole	$\pm 10$ mA

### Temperature

Operating	0 to + 70°C
Storage	- 25 to + 85°C

### Notes:

1. Input and output signal voltage referenced to supply common.
2. Output is short circuit protected to common.  
DO NOT CONNECT TO  $\pm V_s$ .
3. Adjustable to zero.

(All case dimensions are max.)

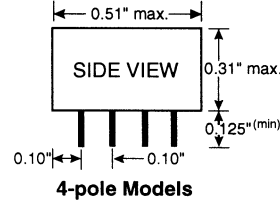

(All pins are 0.01" x 0.02"  $\pm 0.005$ ")

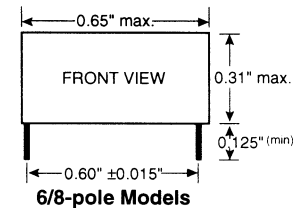
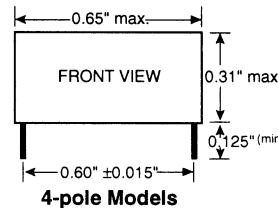
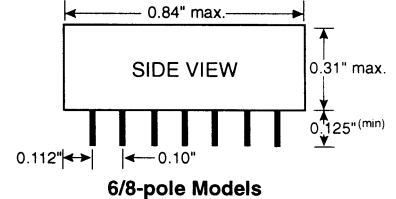

### TOP VIEW

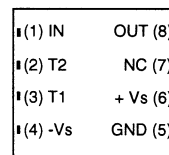

### TOP VIEW

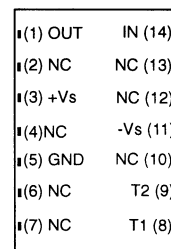

Recommend PC board hole 0.025"

### Filter Mounting Assembly-See FMA-01A

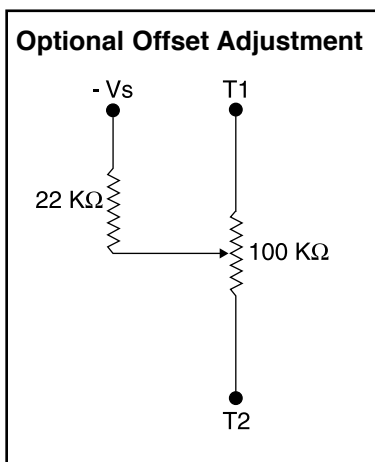

## Ordering Information

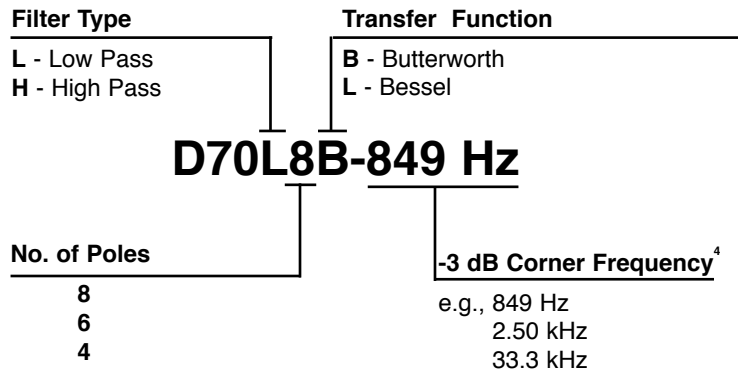

4. How to specify Corner Frequencies:  
Corner frequencies are specified by attaching a three digit frequency designator to the basic model number. Corner frequencies can range from 100 Hz to 50.0 kHz.

We hope the information given here will be helpful. The information is based on data and our best knowledge, and we consider the information to be true and accurate. Please read all statements, recommendations or suggestions herein in conjunction with our conditions of sale which apply to all goods supplied by us. We assume no responsibility for the use of these statements, recommendations or suggestions, nor do we intend them as a recommendation for any use which would infringe any patent or copyright. **IN-00D70-01**



**Appendix A**

**Theoretical Transfer Characteristics**

f/fc (Hz)	Amp (dB)	Phase (deg)	Delay <sup>1</sup> (sec)
0.00	0.00	0.00	.336
0.10	-0.028	-12.1	.336
0.20	-0.111	-24.2	.336
0.30	-0.251	-36.3	.336
0.40	-0.448	-48.4	.336
0.50	-0.705	-60.6	.336
0.60	-1.02	-72.7	.336
0.70	-1.41	-84.8	.336
0.80	-1.86	-96.8	.335
0.85	-2.11	-103	.334
0.90	-2.40	-109	.333
0.95	-2.69	-115	.332
1.00	-3.01	-121	.330
1.10	-3.71	-133	.325
1.20	-4.51	-144	.318
1.30	-5.39	-156	.308
1.40	-6.37	-166	.295
1.50	-7.42	-177	.280
1.60	-8.54	-187	.263
1.70	-9.71	-195	.246
1.80	-10.9	-204	.228
1.90	-12.2	-212	.211
2.00	-13.4	-219	.194
2.25	-16.5	-235	.158
2.50	-19.5	-248	.129
2.75	-22.4	-259	.107
3.00	-25.1	-267	.089
3.25	-27.6	-275	.076
3.50	-30.0	-281	.065
4.00	-34.4	-291	.049
5.00	-41.9	-305	.031
6.00	-48.1	-315	.021
7.00	-53.4	-321	.016
8.00	-58.0	-326	.012
9.00	-62.0	-330	.009
10.0	-65.7	-333	.008

**Frequency Response**

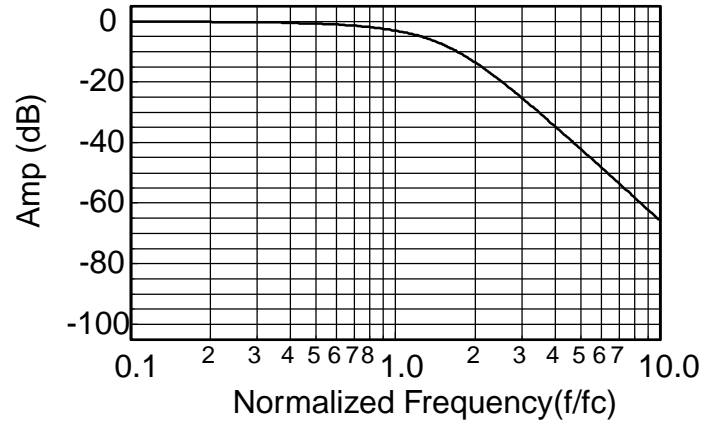

**Delay (Normalized)**

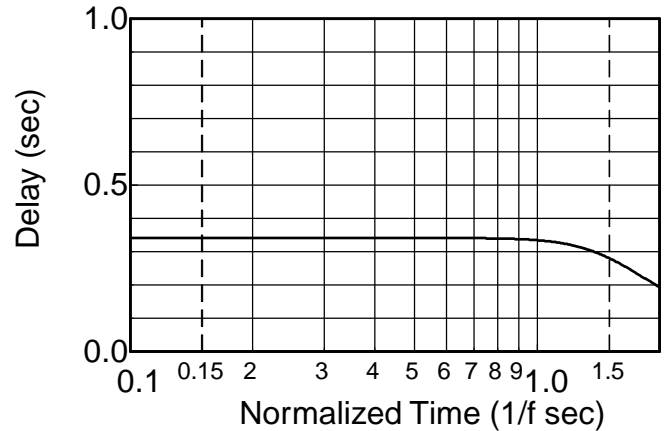

**Step Response**

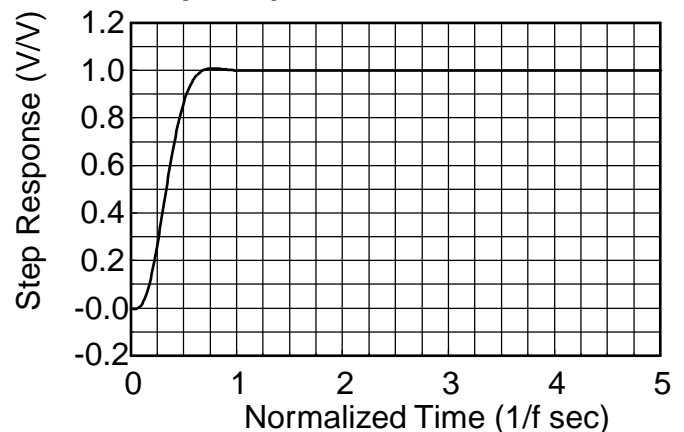

**1. Normalized Group Delay:**

The above delay data is normalized to a corner frequency of 1.0Hz. The actual delay is the normalized delay divided by the actual corner frequency (fc).

$$\text{Actual Delay} = \frac{\text{Normalized Delay}}{\text{Actual Corner Frequency (fc) in Hz}}$$



**Appendix A**

**Theoretical Transfer Characteristics**

f/fc (Hz)	Amp (dB)	Phase (deg)	Delay <sup>1</sup> (sec)
0.00	0.00	0.00	.430
0.10	-0.029	-15.5	.430
0.20	-0.116	-31.0	.430
0.30	-0.261	-46.5	.430
0.40	-0.465	-62.0	.430
0.50	-0.728	-77.4	.430
0.60	-1.05	-92.9	.430
0.70	-1.44	-108	.430
0.80	-1.89	-124	.430
0.85	-2.15	-132	.430
0.90	-2.42	-139	.430
0.95	-2.70	-147	.430
1.00	-3.01	-155	.430
1.10	-3.68	-170	.429
1.20	-4.44	-186	.428
1.30	-5.29	-201	.426
1.40	-6.23	-216	.422
1.50	-7.29	-232	.416
1.60	-8.46	-246	.401
1.70	-9.74	-261	.393
1.80	-11.1	-275	.376
1.90	-12.6	-287	.357
2.00	-14.2	-300	.335
2.25	-18.3	-328	.279
2.50	-22.6	-351	.228
2.75	-26.7	-369	.187
3.00	-30.7	-385	.156
3.25	-34.5	-398	.131
3.50	-38.1	-408	.111
4.00	-44.7	-426	.083
5.00	-55.9	-449	.052
6.00	-65.2	-465	.036
7.00	-73.2	-476	.026
8.00	-80.1	-484	.020
9.00	-86.2	-490	.015
10.0	-91.6	-495	.013

**Frequency Response**

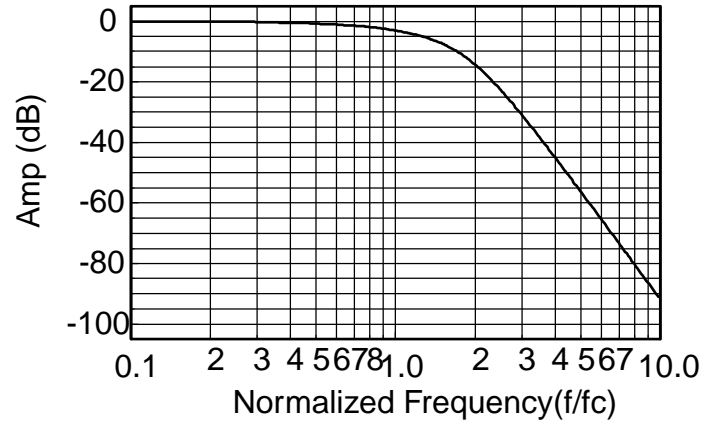

**Delay (Normalized)**

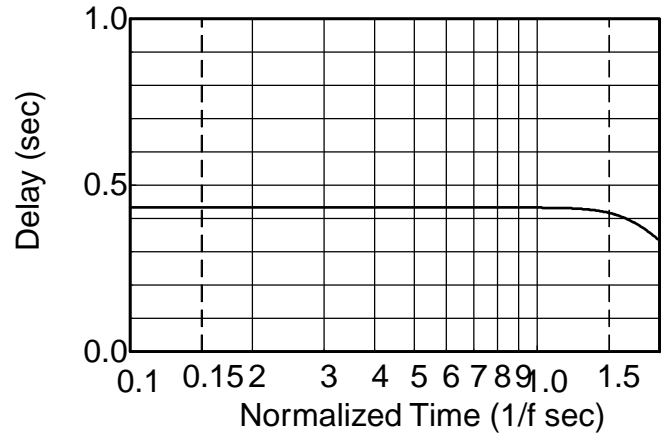

**Step Response**

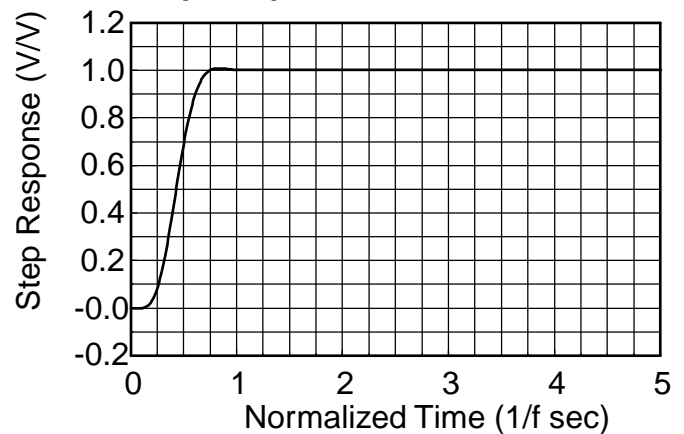

**1. Normalized Group Delay:**

The above delay data is normalized to a corner frequency of 1.0Hz. The actual delay is the normalized delay divided by the actual corner frequency (fc).

$$\text{Actual Delay} = \frac{\text{Normalized Delay}}{\text{Actual Corner Frequency (fc) in Hz}}$$



**Appendix A**

**Theoretical Transfer Characteristics**

f/fc (Hz)	Amp (dB)	Phase (deg)	Delay <sup>1</sup> (sec)
0.00	0.00	0.00	.506
0.10	-0.029	-18.2	.506
0.20	-0.117	-36.4	.506
0.30	-0.264	-54.7	.506
0.40	-0.470	-72.9	.506
0.50	-0.737	-91.1	.506
0.60	-1.06	-109	.506
0.70	-1.45	-128	.506
0.80	-1.91	-146	.506
0.85	-2.16	-155	.506
0.90	-2.42	-164	.506
0.95	-2.71	-173	.506
1.00	-3.01	-182	.506
1.10	-3.67	-200	.506
1.20	-4.40	-219	.506
1.30	-5.20	-237	.506
1.40	-6.10	-255	.505
1.50	-7.08	-273	.504
1.60	-8.16	-291	.502
1.70	-9.36	-309	.498
1.80	-10.7	-327	.492
1.90	-12.1	-345	.482
2.00	-13.7	-362	.468
2.25	-18.1	-402	.417
2.50	-23.1	-436	.352
2.75	-28.3	-465	.291
3.00	-33.4	-489	.241
3.25	-38.3	-509	.201
3.50	-43.1	-526	.170
4.00	-51.8	-552	.126
5.00	-66.8	-587	.077
6.00	-79.2	-610	.052
7.00	-89.8	-626	.038
8.00	-99.0	-638	.029
9.00	-107	-647	.023
10.0	-114	-655	.018

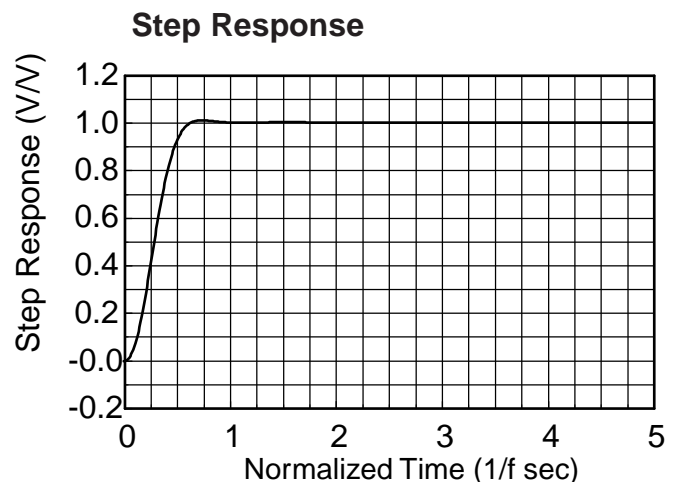
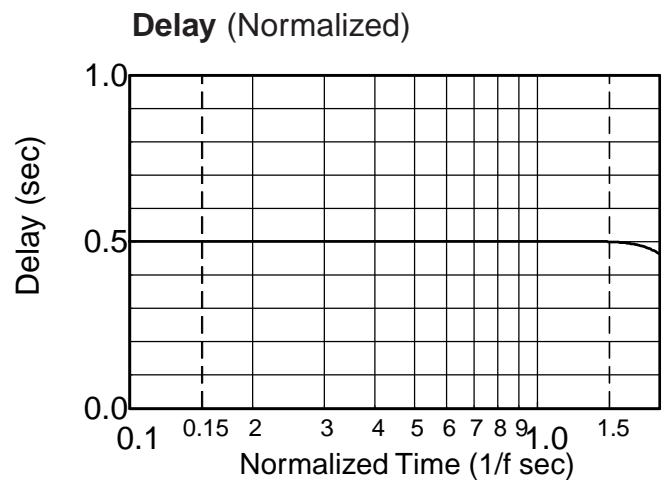
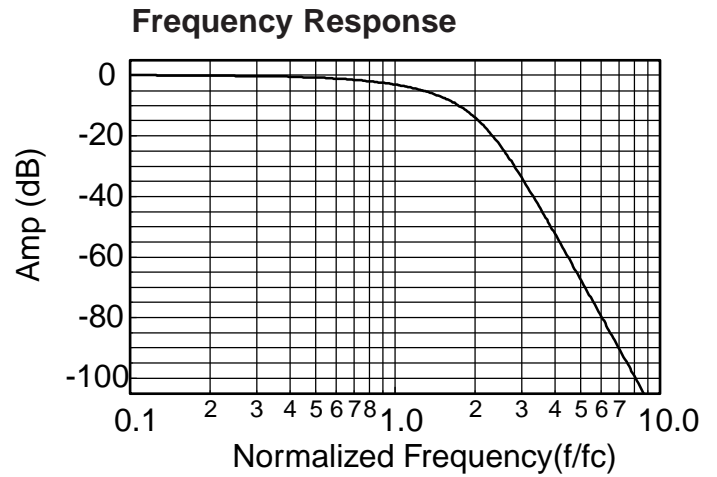

**1. Normalized Group Delay:**

The above delay data is normalized to a corner frequency of 1.0Hz. The actual delay is the normalized delay divided by the actual corner frequency (fc).

$$\text{Actual Delay} = \frac{\text{Normalized Delay}}{\text{Actual Corner Frequency (fc) in Hz}}$$





**Appendix A**

**Theoretical Transfer Characteristics**

f/fc (Hz)	Amp (dB)	Phase (deg)	Delay <sup>1</sup> (sec)
0.00	0.00	0.00	.416
0.10	0.00	-15.0	.418
0.20	0.00	-30.1	.423
0.30	-0.00	-45.5	.433
0.40	-0.003	-61.4	.449
0.50	-0.017	-78.0	.474
0.60	-0.072	-95.7	.511
0.70	-0.243	-115	.558
0.80	-0.674	-136	.604
0.85	-1.047	-147	.619
0.90	-1.555	-158	.622
0.95	-2.21	-169	.612
1.00	-3.01	-180	.588
1.10	-4.97	-200	.513
1.20	-7.24	-217	.427
1.30	-9.62	-231	.350
1.40	-12.0	-242	.289
1.50	-14.3	-252	.241
1.60	-16.4	-260	.204
1.70	-18.5	-266	.175
1.80	-20.5	-272	.152
1.90	-22.3	-277	.134
2.00	-24.1	-282	.119
2.25	-28.2	-291	.091
2.50	-31.8	-299	.072
2.75	-35.1	-304	.059
3.00	-38.2	-309	.049
3.25	-41.0	-313	.041
3.50	-43.5	-317	.035
4.00	-48.2	-322	.027
5.00	-55.9	-330	.017
6.00	-62.3	-335	.012
7.00	-67.6	-339	.009
8.00	-72.2	-341	.007
9.00	-76.3	-343	.005
10.0	-80.0	-345	.004

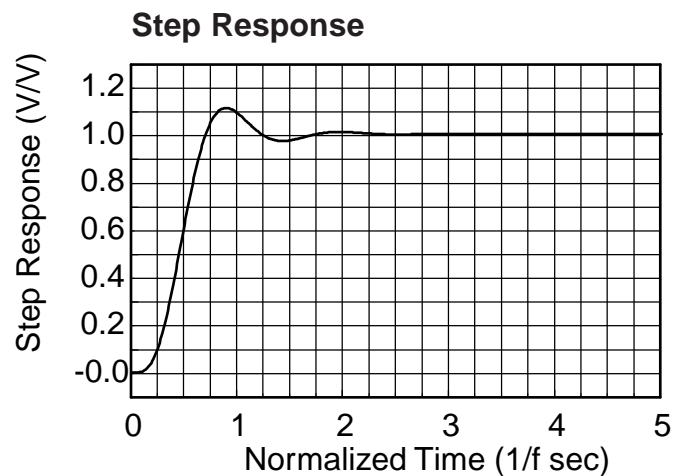
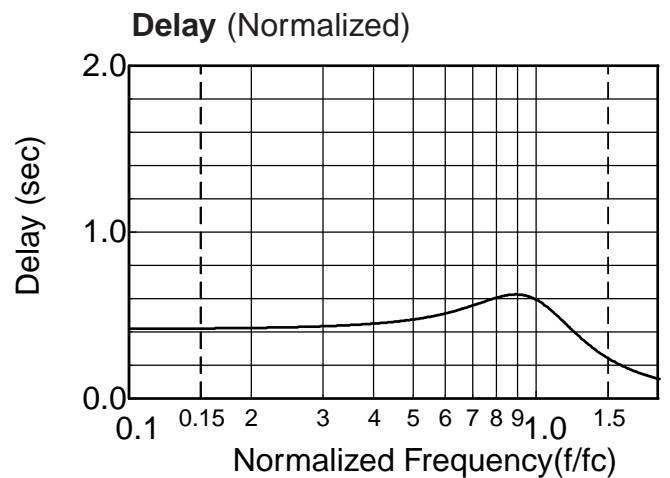
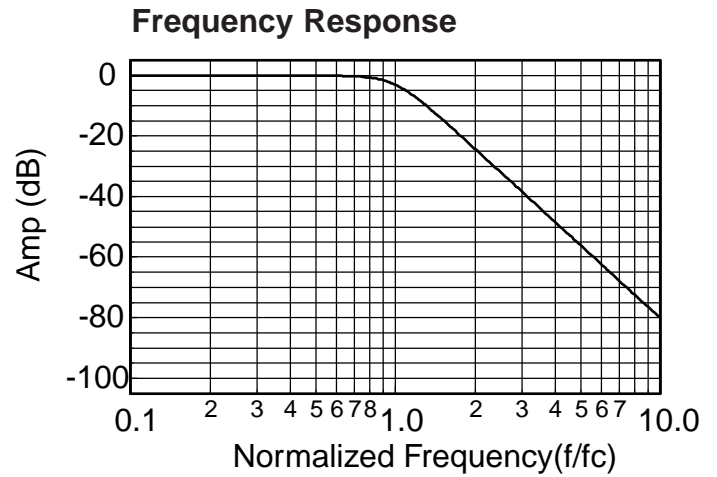

**1. Normalized Group Delay:**

The above delay data is normalized to a corner frequency of 1.0Hz. The actual delay is the normalized delay divided by the actual corner frequency (fc).

$$\text{Actual Delay} = \frac{\text{Normalized Delay}}{\text{Actual Corner Frequency (fc) in Hz}}$$



**Appendix A**

**Theoretical Transfer Characteristics**

f/fc (Hz)	Amp (dB)	Phase (deg)	Delay <sup>1</sup> (sec)
0.00	0.00	0.00	.615
0.10	0.00	-22.2	.617
0.20	0.00	-44.5	.624
0.30	0.00	-67.2	.637
0.40	0.00	-90.4	.656
0.50	-0.001	-115	.685
0.60	-0.009	-140	.731
0.70	-0.060	-167	.803
0.80	-0.289	-198	.911
0.85	-0.578	-215	.970
0.90	-1.080	-233	1.02
0.95	-1.88	-252	1.03
1.00	-3.01	-270	1.00
1.10	-6.17	-304	.845
1.20	-9.96	-331	.660
1.30	-13.9	-352	.518
1.40	-17.6	-368	.417
1.50	-21.2	-382	.345
1.60	-24.5	-393	.291
1.70	-27.7	-403	.251
1.80	-30.6	-412	.219
1.90	-33.5	-419	.193
2.00	-36.1	-425	.171
2.25	-42.3	-439	.132
2.50	-47.8	-450	.105
2.75	-52.7	-458	.086
3.00	-57.3	-465	.071
3.25	-61.4	-471	.060
3.50	-65.3	-476	.052
4.00	-72.2	-484	.039
5.00	-83.9	-496	.025
6.00	-93.4	-503	.017
7.00	-101	-508	.012
8.00	-108	-512	.0097
9.00	-115	-515	.0076
10.0	-120	-518	.0062

**Frequency Response**

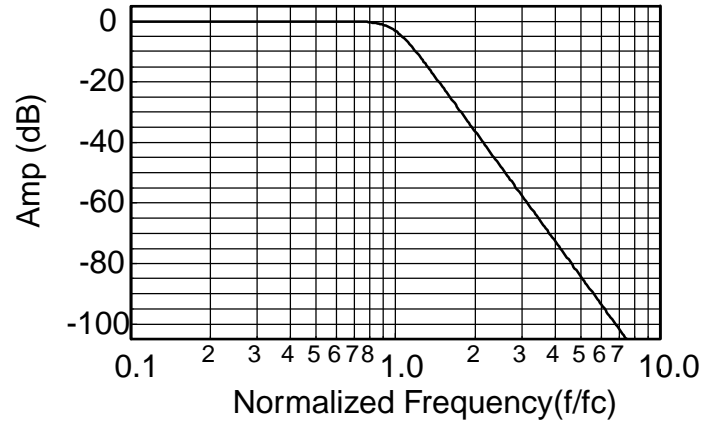

**Delay (Normalized)**

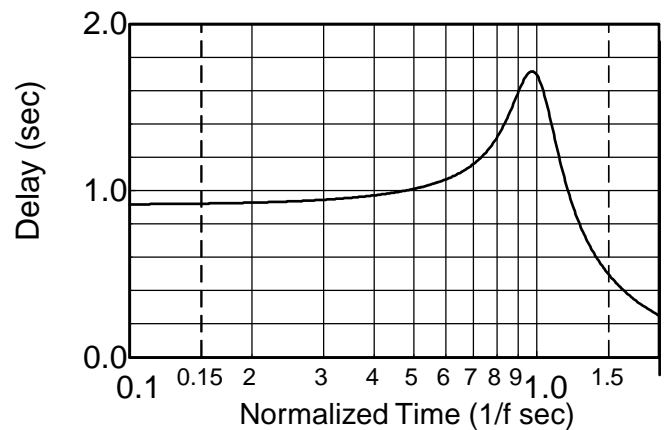

**Step Response**

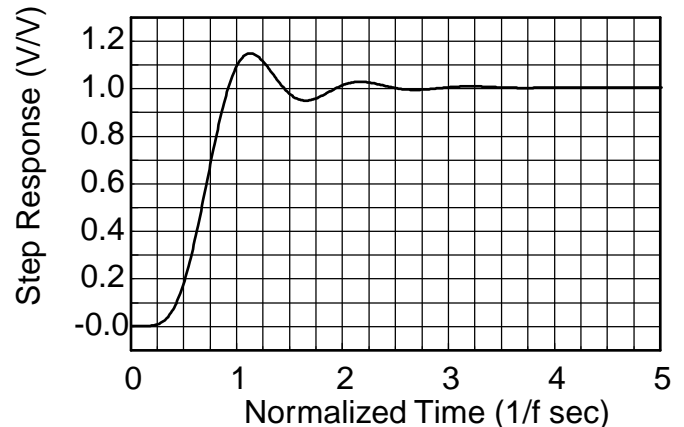

**1. Normalized Group Delay:**

The above delay data is normalized to a corner frequency of 1.0Hz. The actual delay is the normalized delay divided by the actual corner frequency (fc).

$$\text{Actual Delay} = \frac{\text{Normalized Delay}}{\text{Actual Corner Frequency (fc) in Hz}}$$



**Appendix A**

**Theoretical Transfer Characteristics**

f/fc (Hz)	Amp (dB)	Phase (deg)	Delay <sup>1</sup> (sec)
0.00	0.00	0.00	.816
0.10	0.00	-29.4	.819
0.20	0.00	-59.0	.828
0.30	0.00	-89.1	.843
0.40	0.00	-120	.867
0.50	0.00	-152	.903
0.60	-0.001	-185	.956
0.70	-0.014	-221	1.04
0.80	-0.121	-261	1.19
0.85	-0.311	-283	1.29
0.90	-0.738	-307	1.40
0.95	-1.58	-333	1.48
1.00	-3.01	-360	1.46
1.10	-7.48	-408	1.17
1.20	-12.9	-445	.873
1.30	-18.2	-472	.672
1.40	-23.4	-494	.540
1.50	-28.2	-511	.448
1.60	-32.7	-526	.380
1.70	-36.9	-539	.328
1.80	-40.8	-550	.287
1.90	-44.6	-560	.253
2.00	-48.2	-568	.226
2.25	-56.3	-586	.174
2.50	-63.7	-600	.139
2.75	-70.3	-611	.113
3.00	-76.3	-621	.094
3.25	-81.9	-629	.080
3.50	-87.1	-635	.069
4.00	-96.3	-646	.052
5.00	-112	-661	.033
6.00	-125	-671	.023
7.00	-135	-678	.017
8.00	-144	-683	.013
9.00	-153	-687	.010
10.0	-160	-691	.008

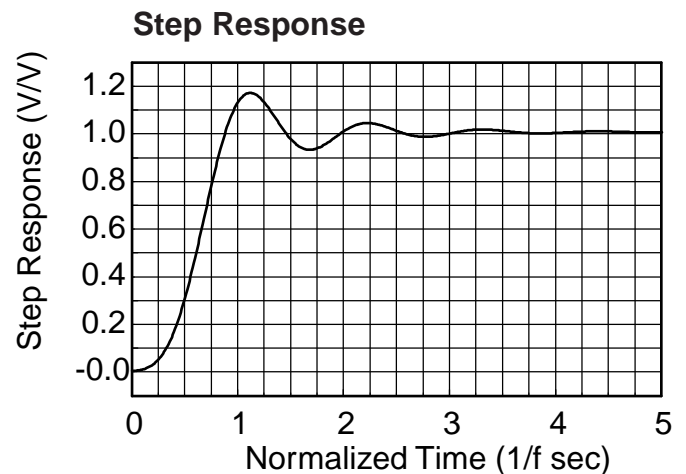
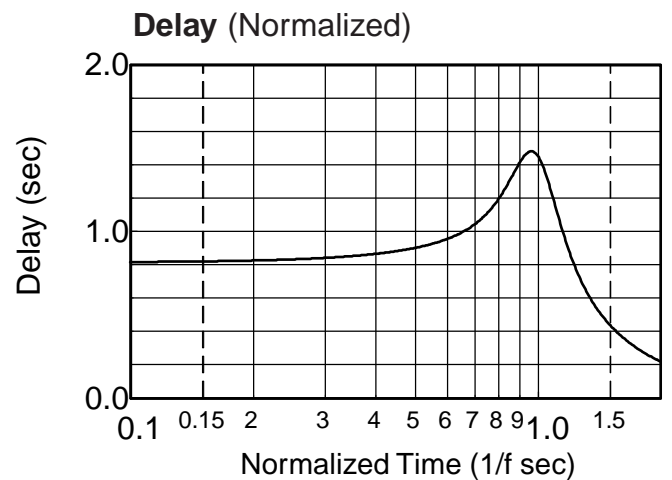
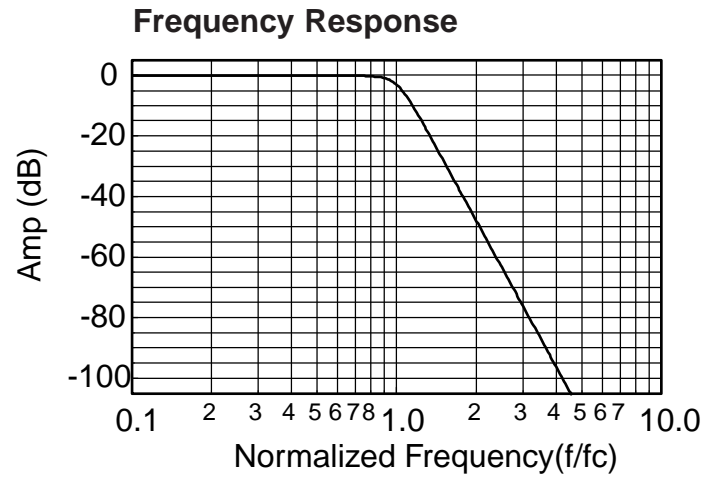

**1. Normalized Group Delay:**

The above delay data is normalized to a corner frequency of 1.0Hz. The actual delay is the normalized delay divided by the actual corner frequency (fc).

$$\text{Actual Delay} = \frac{\text{Normalized Delay}}{\text{Actual Corner Frequency (fc) in Hz}}$$



**Theoretical Transfer Characteristics**

f/fc (Hz)	Amp (dB)	Phase (deg)	Delay <sup>1</sup> (sec)
0.10	-80.0	345	.418
0.20	-55.9	330	.423
0.30	-41.8	314	.433
0.40	-31.8	299	.449
0.50	-24.1	282	.474
0.60	-17.8	264	.511
0.70	-12.6	245	.558
0.80	-8.43	224	.604
0.85	-6.69	213	.619
0.90	-5.22	202	.622
0.95	-3.99	191	.612
1.00	-3.01	180	.588
1.20	-0.908	143	.427
1.40	-0.285	118	.289
1.60	-0.100	100	.204
1.80	-0.039	87.6	.152
2.00	-0.017	78.0	.119
2.50	-0.003	61.4	.072
3.00	-0.001	50.7	.049
4.00	0.00	37.8	.027
5.00	0.00	30.1	.017
6.00	0.00	25.1	.012
7.00	0.00	21.4	.009
8.00	0.00	18.8	.007
9.00	0.00	16.7	.005
10.0	0.00	15.0	.004

**Frequency Response**

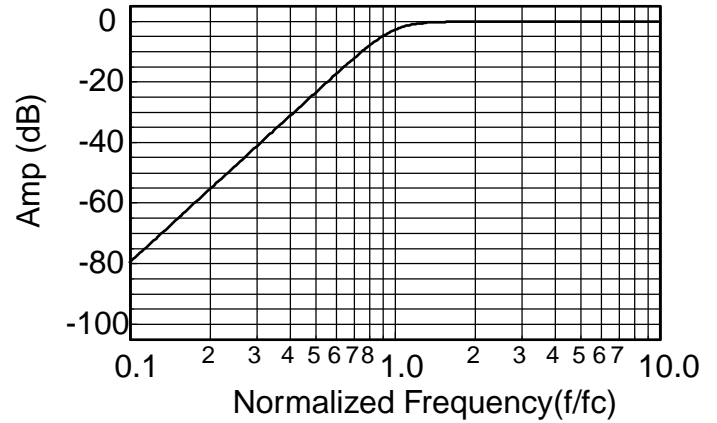

**1. Normalized Group Delay:**

The above delay data is normalized to a corner frequency of 1.0Hz. The actual delay is the normalized delay divided by the actual corner frequency (fc).

$$\text{Actual Delay} = \frac{\text{Normalized Delay}}{\text{Actual Corner Frequency (fc) in Hz}}$$



**Theoretical Transfer Characteristics**

f/fc (Hz)	Amp (dB)	Phase (deg)	Delay <sup>1</sup> (sec)
0.10	-120	518	0.617
0.20	-83.9	496	0.624
0.30	-62.7	473	0.637
0.40	-47.8	450	0.656
0.50	-36.1	425	0.685
0.60	-26.6	400	0.731
0.70	-18.6	373	0.803
0.80	-11.9	342	0.911
0.85	-9.05	325	0.970
0.90	-6.57	307	1.017
0.95	-4.55	288	1.033
1.00	-3.01	270	1.005
1.20	-0.46	209	0.660
1.40	-0.08	172	0.417
1.60	-0.02	147	0.291
1.80	-0.00	128	0.219
2.00	-0.00	115	0.171
2.50	-0.00	90.4	0.105
3.00	-0.00	74.8	0.071
4.00	0.00	55.8	0.039
5.00	0.00	44.5	0.025
6.00	0.00	37.0	0.017
7.00	0.00	31.7	0.013
8.00	0.00	27.7	0.010
9.00	0.00	24.6	0.008
10.0	0.00	22.2	0.006

**Frequency Response**

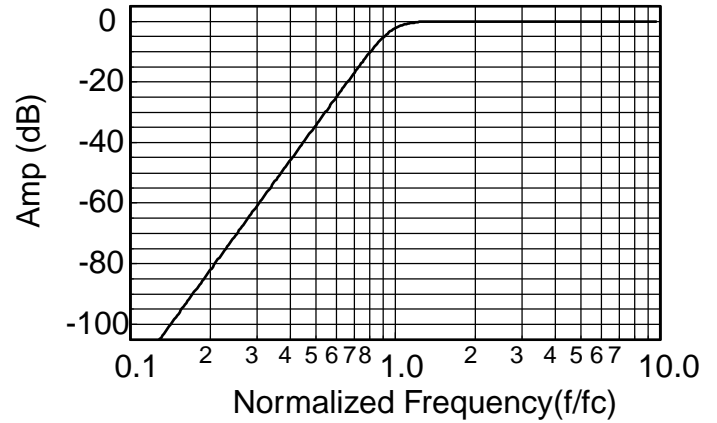

**1. Normalized Group Delay:**

The above delay data is normalized to a corner frequency of 1.0Hz. The actual delay is the normalized delay divided by the actual corner frequency (fc).

$$\text{Actual Delay} = \frac{\text{Normalized Delay}}{\text{Actual Corner Frequency (fc) in Hz}}$$



**Theoretical Transfer Characteristics**

<b>f/fc (Hz)</b>	<b>Amp (dB)</b>	<b>Phase (deg)</b>	<b>Delay<sup>1</sup> (sec)</b>
0.10	-160	691	0.819
0.20	-112	661	0.828
0.30	-83.7	631	0.843
0.40	-63.7	600	0.867
0.50	-48.2	568	0.903
0.60	-35.5	535	.956
0.70	-24.8	499	1.04
0.80	-15.6	459	1.19
0.85	-11.6	437	1.29
0.90	-8.06	413	1.40
0.95	-5.15	386	1.48
1.00	-3.01	360	1.46
1.20	-0.229	275	0.873
1.40	-0.020	226	0.540
1.60	-0.002	194	0.380
1.80	0.00	170	0.287
2.00	0.00	152	0.226
2.50	0.00	120	0.139
3.00	0.00	99.2	0.094
4.00	0.00	74.0	0.052
5.00	0.00	59.0	0.033
6.00	0.00	49.0	0.023
7.00	0.00	42.1	0.017
8.00	0.00	36.8	0.013
9.00	0.00	32.7	0.010
10.0	0.00	29.4	0.008

**Frequency Response**

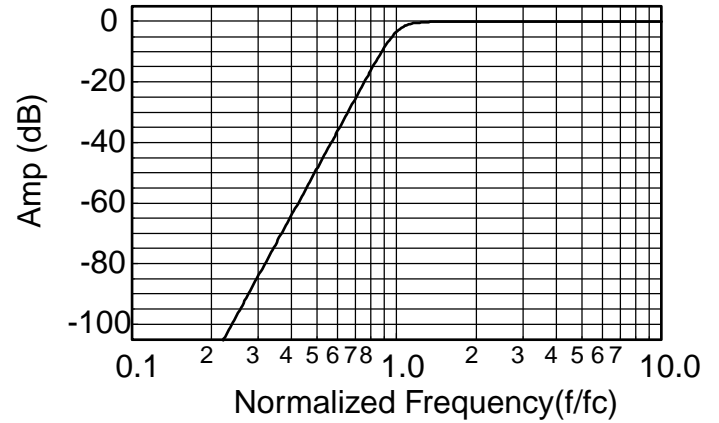

**1. Normalized Group Delay:**

The above delay data is normalized to a corner frequency of 1.0Hz. The actual delay is the normalized delay divided by the actual corner frequency (fc).

$$\text{Actual Delay} = \frac{\text{Normalized Delay}}{\text{Actual Corner Frequency (fc) in Hz}}$$