

FEATURES

- ULTRA LOW CAPACITANCE (AS LOW AS 0.8pF)
- EIA SIZES 0402 AND 0603
- MEETS STANDARDS OF IEC 61000-4-2, LEVEL 4
- IDEAL FOR USB2.0, IEEE1394 & HDMI HIGH SPEED DATA APPLICATIONS
- Pb-FREE REFLOW PROCESS COMPATIBLE

RoHS Compliant

includes all homogeneous materials

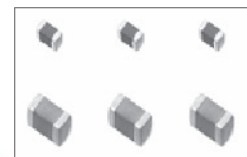

SPECIFICATIONS

*See Part Number System for Details

Case Size	Part Number	Maximum WVDC	1mA Voltage (nominal)	Capacitance (pF)			Max. Peak Current at 8/20μS, 2 Times	Max. ESD IEC 61000-4-2	Type
				1MHz		1KHz			
				Max.	Typical	Typical			
0402	NVT0402H100A800TRF	10	80	1	0.8	-	-	Contact discharge 8kV	High Speed, Ultra Low Capacitance
	NVT0402H5R0B800TRF	5	80	2	1.5	-	-		
	NVT0402H5R0D500TRF	5	50	3	2.1	-	-		
	NVT0402H180D800TRF	18	80	3	2.1	-	-		
	NVT0402H180D171TRF	18	170	3	2.1	-	-		
0603	NVT0603H100A800TRF	10	80	1	0.8	-	-		
	NVT0603H5R0D500TRF	5	50	3	2.1	-	-		
	NVT0603H180D800TRF	18	80	3	2.1	-	-		
	NVT0603H180D171TRF	18	170	3	2.1	-	-		
0402	NVT0402S6R7S120TRF	6.7	12	220	150	175	10		
	NVT0402S110R180TRF	11	18	150	120	140	10		
	NVT0402S130R220TRF	13	22	150	100	116	10		
	NVT0402S160L270TRF	16	27	47	33	37	10		
	NVT0402S160J270TRF	16	27	20	15	16.5	3		
	NVT0402S300M420TRF	30	42	56	40	45	10		
0603	NVT0603S6R7T120TRF	6.7	12	330	250	290	20		
	NVT0603S110S180TRF	11	18	220	180	210	20		
	NVT0603S130S220TRF	13	22	220	160	185	20		
	NVT0603S160Q270TRF	16	27	100	85	100	20		
	NVT0603S160L270TRF	16	27	47	33	37	20		
	NVT0603S160J270TRF	16	27	20	15	16.5	3		
	NVT0603S260Q330TRF	26	33	100	85	100	20		
	NVT0603S300N420TRF	30	42	68	55	63	15		

Notes:

1. Maximum Allowable Voltage - max. DC voltage that can be applied continuously within the operating temperature of the part (-40°C ~+85°C).
2. Varistor Voltage - varistor starting voltage between terminals at 1mA DC (also known as the breakdown voltage)
3. Maximum Peak Current - the max. current under the standard pulse 8/20μS, 2 times based on IEC60.
4. Maximum ESD - the max. current under ESD based on IEC 61000-4-2, 10 times (5 times each positive-negative polarity).

PART NUMBERING SYSTEM

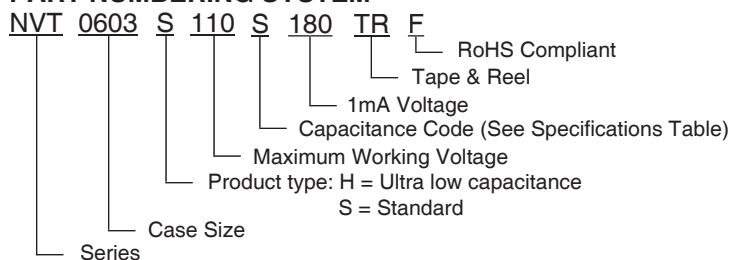

DIMENSIONS (mm)

Case Size	L	W	T	P
0402	1.00 ± 0.05	0.50 ± 0.05	0.50 ± 0.05	0.20 ± 0.10
0603	1.60 ± 0.10	0.80 ± 0.10	0.80 ± 0.10	0.30 ± 0.20

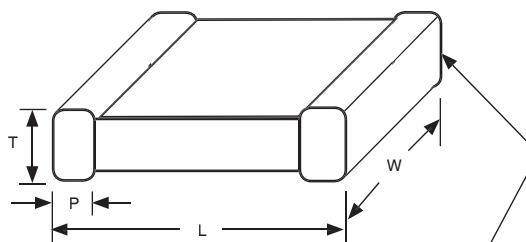

Termination Material: Silver (Ag) base, Nickel (Ni) barrier, 100% Sn finish



RECOMMENDED LAND PATTERN DIMENSIONS (mm)

Case Size	Reflow Soldering		
	A	B	C
0402	0.4 ~ 0.5	0.4 ~ 0.5	0.4 ~ 0.5
0603	0.8 ~ 1.0	0.6 ~ 0.8	0.6 ~ 0.8

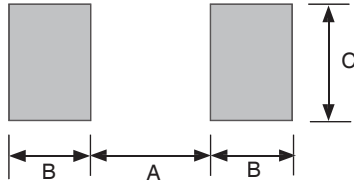

RECOMMENDED REFLOW SOLDERING TEMPERATURE PROFILE

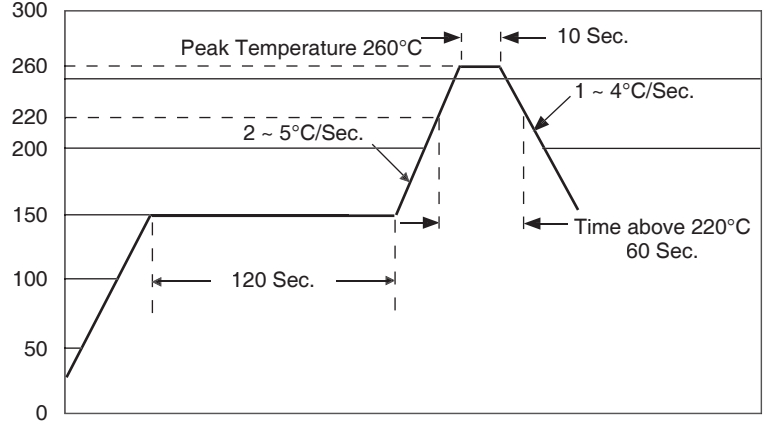

CARRIER TAPE DIMENSIONS (mm)

Type	A	B	W	F	E	P ₁	T ₁	T ₂	Qty/Reel
NVT0402	0.62 ± 0.05	1.12 ± 0.05	8.0 ± 0.2	3.50 ± 0.05	1.75 ± 0.10	2.00 ± 0.05	0.7 max.	1.0 max.	10,000
NVT0603	1.00 ± 0.10	1.80 ± 0.10				4.00 ± 0.05	1.1 max.	1.4 max.	4,000

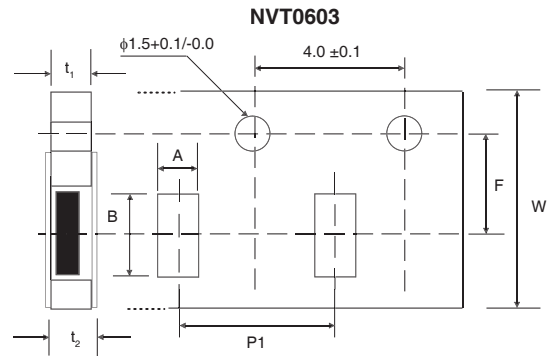
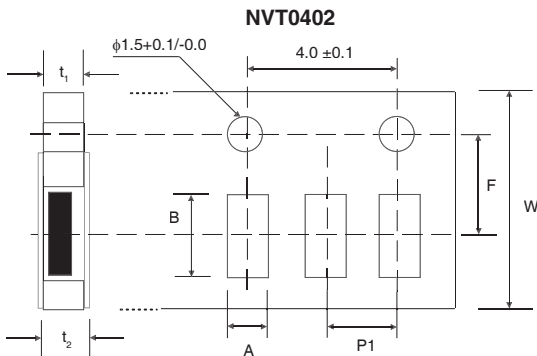

REEL DIMENSIONS (mm)

A +0/-3	B +1/-0	C ± 0.5	D ± 0.8	E ± 0.5	W ± 0.3
180	60	13	21.0	2.0	9.0

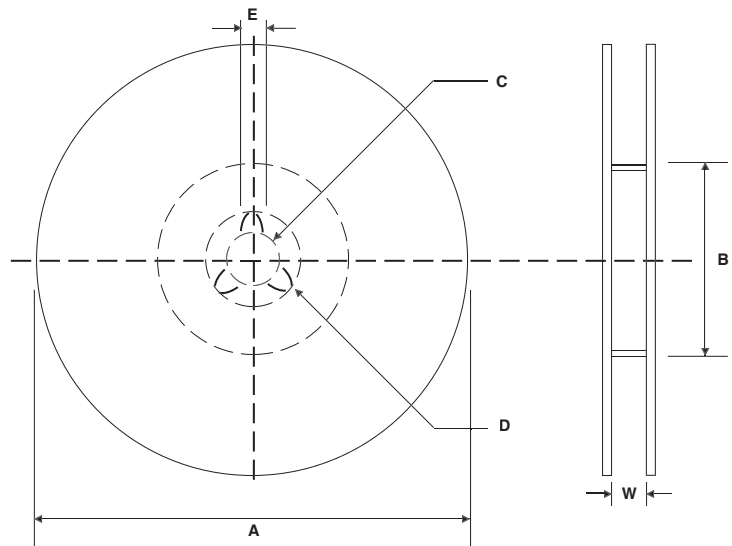

CROSS REFERENCE GUIDE

NIC P/N	Amotech	AVX	EPCOS	ICT	Littlefuse	Panasonic	TDK
NVT0603S6R7S120TRF	AVL3M03300	VC06033A100	-	ICVN1003A100	V3.5MLA0603	EZJZ1V120JA	-
NVT0402S6R7S120TRF	AVL5M02200	VC04025X150	-	ICVN0505X150	V5.5MLA0402	EZJZ0V120JA	AVR-M1005C080MTAAB AVR-M1005C080MTABB AVR-M1005C080MTACB
NVT0603S6R7S120TRF	AVL5M03300	VC060305A150	CN0603M4G	ICVN1005A150	V5.5MLA0603	EZJZ1V120KA	AVR-M1608C080MTAAB
NVT0402S6R7S120TRF	AVL8M02200	VC04029X200	-	ICVN0509X200	V9MLA0402 V9MLA0402L	EZJZ0V120JA	AVR-M1005C120MTAAB
NVT0603S6R7S120TRF	AVL8M03300	VC060309A200	CN0603M6G CN0603M7G	ICVN1009A200	V9MLA0603	EZJZ1V120KA	AVR-1608C120MT6AB
NVT0402S160L270TRF	AVL11L02200	-	-	-	-	EZJZ0V270EA	-
NVT0603S160Q270TRF	AVL11L03300	-	CN0603L8G	-	-	EZJZ1V270GA	-
NVT0402S160L270TRF	AVL14K02200	VC040214X300	-	ICVN0514X300	V14MLA0402	EZJZ0V270EA	-
NVT0603S160Q270TRF	AVL14K03300	VC060314A300	CN0603K11G	ICVN1014A300	V14MLA0603	EZJZ1V270GA	AVR-M1608C180MT6AB
NVT0402S160L270TRF	AVL18K02200	VC040218X400	NC0402L14GK2	-	V18MLA0402 V18MLE0402	EZJZ0V270EA	-
NVT0603S160Q270TRF	AVL18K03300	VC060318A400	CN0603K14G	-	V18MLA0603 V18MLE0603	EZJZ1V270GA	AVR-M1608C220KT6AB AVR-M1608C220KT2AB
NVT0402S160L270TRF	-	-	-	ICVN0518X400	-	EZJZ0V270EA EZJZ0V270RA	AVR-M1005C270MTAAB AVR-M1005C270MTABB
NVT0603S160Q270TRF	-	-	CN0603K17G NC0603K17LCG	ICVN1018A400	-	EZJZ1V270GA EZJZ1V270GA EZJZ1V270EA EZJZ1V270RA	AVR-M1608C270KT6AB AVR-M1608C270KT2AB AVR-M1608C270KTAAB AVR-M1608C270KTABB
NVT0603S260Q270TRF	-	VC060325A580	NC0603K20G	ICVN1026A580	V26MLA0603	EZJZ1V330GA	-

NIC P/N	EPCOS	AVX	ICT	Panasonic	Littlefuse
NVT0402H5R0D500TRF	-	-	-	EZJZ0V500AA	-
NVT0402H100A800TRF	-	-	-	EZJZ0V80010	-
NVT0603H100A800TRF	-	-	-	EZJZ1V80010	-
NVT0402H100A800TRF	-	VC04AG183R0YA1	-	EZJZ0V800AA	V0402MHS03
NVT0603H180D800TRF	CM0603V650RFGK2	VC06AG183R0YA1	-	EZJZ1V800AA	-