



# 1 $\mu$ A Supply Current, 1Mbps, 3.0V to 5.5V, RS-232 Transceivers with AutoShutdown Plus

## General Description

The MAX3224–MAX3227/MAX3244/MAX3245 are 3V-powered EIA/TIA-232 and V.28/V.24 communications interfaces with automatic shutdown/wakeup features and high data-rate capabilities.

All devices achieve a 1 $\mu$ A supply current using Maxim's revolutionary AutoShutdown Plus™ feature. These devices automatically enter a low-power shutdown mode when the RS-232 cable is disconnected or the transmitters of the connected peripherals are inactive, and the UART driving the transmitter inputs is inactive for more than 30 seconds. They turn on again when they sense a valid transition at any transmitter or receiver input. AutoShutdown Plus saves power without changes to the existing BIOS or operating system.

The MAX3225/MAX3227/MAX3245 also feature MegaBaud™ operation, guaranteeing 1Mbps for high-speed applications such as communicating with ISDN modems. The MAX3224/MAX3226/MAX3244 guarantee 250kbps operation. The transceivers have a proprietary low-dropout transmitter output stage enabling true RS-232 performance from a +3.0V to +5.5V supply with a dual charge pump. The charge pump requires only four small 0.1 $\mu$ F capacitors for operation from a 3.3V supply. The MAX3224–MAX3227 feature a logic-level output (READY) that asserts when the charge pump is regulating and the device is ready to begin transmitting.

All devices are available in a space-saving TQFN, TSSOP, and SSOP packages.

## Applications

Notebook, Subnotebook, and Palmtop Computers

Cellular Phones

Battery-Powered Equipment

Handheld Equipment

Peripherals

Printers

## Next Generation Device Features

- ◆ **For Smaller Packaging:**  
MAX3228/MAX3229: +2.5V to +5.5V RS-232 Transceivers in UCSP™
- ◆ **For Low-Voltage or Data Cable Applications:**  
MAX3380E/MAX3381E: +2.35V to +5.5V, 1 $\mu$ A, 2 Tx/2 Rx RS-232 Transceivers with  $\pm$ 15kV ESD-Protected I/O and Logic Pins
- ◆ **For Integrated ESD Protection:**  
MAX3222E/MAX3232E/MAX3237E/MAX3241E/  
MAX3246E:  $\pm$ 15kV ESD-Protected, Down to 10nA, +3.0V to +5.5V, Up to 1Mbps, True RS-232 Transceivers (MAX3246E Available in UCSP)

## Ordering Information

| PART        | TEMP RANGE     | PIN-PACKAGE |
|-------------|----------------|-------------|
| MAX3224CPP+ | 0°C to +70°C   | 20 PDIP     |
| MAX3224CAP+ | 0°C to +70°C   | 20 SSOP     |
| MAX3224CTP+ | 0°C to +70°C   | 20 TQFN-EP* |
| MAX3224CUP+ | 0°C to +70°C   | 20 TSSOP    |
| MAX3224EPP+ | -40°C to +85°C | 20 PDIP     |
| MAX3224EAP+ | -40°C to +85°C | 20 SSOP     |
| MAX3224ETP+ | -40°C to +85°C | 20 TQFN-EP* |
| MAX3224EUP+ | -40°C to +85°C | 20 TSSOP    |

+Denotes a lead(Pb)-free/RoHS-compliant package.

\*EP = Exposed pad.

Ordering Information continued at end of data sheet.

## Selector Guide

| PART    | NO. OF DRIVERS/RECEIVERS | GUARANTEED DATA RATE (bps) | READY OUTPUT | Auto-Shutdown Plus |
|---------|--------------------------|----------------------------|--------------|--------------------|
| MAX3224 | 2/2                      | 250k                       | ✓            | ✓                  |
| MAX3225 | 2/2                      | 1M                         | ✓            | ✓                  |
| MAX3226 | 1/1                      | 250k                       | ✓            | ✓                  |
| MAX3227 | 1/1                      | 1M                         | ✓            | ✓                  |
| MAX3244 | 3/5                      | 250k                       | —            | ✓                  |
| MAX3245 | 3/5                      | 1M                         | —            | ✓                  |

AutoShutdown Plus, MegaBaud, and UCSP are trademarks of Maxim Integrated Products, Inc.



# 1µA Supply Current, 1Mbps, 3.0V to 5.5V, RS-232 Transceivers with AutoShutdown Plus

## ABSOLUTE MAXIMUM RATINGS

|   |                                   |   |
|---|-----------------------------------|---|
| V <sub>CC</sub> to GND                      | -0.3V to +6V                      | Continuous Power Dissipation (T <sub>A</sub> = +70°C)   |
| V <sub>+</sub> to GND (Note 1)              | -0.3V to +7V                      |   |
| V <sub>-</sub> to GND (Note 1)              | +0.3V to -7V                      | 16-Pin SSOP (derate 7.14mW/°C above +70°C) .....571mW   |
| V <sub>+</sub> +  V <sub>-</sub>   (Note 1) | +13V                              | 20-Pin PDIP (derate 11.11mW/°C above +70°C) .....889mW  |
| Input Voltages                              |                                   | 20-Pin TQFN (derate 21.3mW/°C above +70°C).....1702.1mW |
| T <sub>IN</sub> , FORCEON, FORCEOFF to GND  | -0.3V to +6V                      | 20-Pin SSOP (derate 8.00mW/°C above +70°C) .....640mW   |
| R <sub>IN</sub> to GND                      | ±25V                              | 20-Pin TSSOP (derate 7.00mW/°C above +70°C) .....559mW  |
| Output Voltages                             |                                   | 28-Pin SO (W) (derate 12.5mW/°C above +70°C) ..... 1W   |
| T <sub>OUT</sub> to GND                     | ±13.2V                            | 28-Pin SSOP (derate 9.52mW/°C above +70°C) .....762mW   |
| R <sub>OUT</sub> , INVALID, READY to GND    | -0.3V to (V <sub>CC</sub> + 0.3V) | Operating Temperature Ranges                            |
| Short-Circuit Duration                      |                                   | MAX32_ _C_ _ .....0°C to +70°C                          |
| T <sub>OUT</sub> to GND                     | Continuous                        | MAX32_ _E_ _ .....-40°C to +85°C                        |
|   |                                   | Storage Temperature Range .....-65°C to +160°C          |
|   |                                   | Lead Temperature (soldering, 10s) .....+300°C           |
|   |                                   | Soldering Temperature (reflow) .....+260°C              |

**Note 1:** V<sub>+</sub> and V<sub>-</sub> can have maximum magnitudes of 7V, but their absolute difference cannot exceed 13V.

Stresses beyond those listed under "Absolute Maximum Ratings" may cause permanent damage to the device. These are stress ratings only, and functional operation of the device at these or any other conditions beyond those indicated in the operational sections of the specifications is not implied. Exposure to absolute maximum rating conditions for extended periods may affect device reliability.

## ELECTRICAL CHARACTERISTICS

(V<sub>CC</sub> = +3V to +5.5V, C1–C4 = 0.1µF, tested at 3.3V ±10%; C1 = 0.047µF, C2–C4 = 0.33µF, tested at 5.0V ±10%; T<sub>A</sub> = T<sub>MIN</sub> to T<sub>MAX</sub>, unless otherwise noted. Typical values are at T<sub>A</sub> = +25°C.)

| PARAMETER  | SYMBOL | CONDITIONS   | MIN                    | TYP   | MAX                   | UNITS |   |
|--|--------|--|------------------------|-------|-----------------------|-------|---|
| <b>DC CHARACTERISTICS</b> (V <sub>CC</sub> = 3.3V or 5.0V, T <sub>A</sub> = +25°C) |        |  |                        |       |                       |       |   |
| Supply Current, AutoShutdown Plus  |        | FORCEON = GND, FORCEOFF = V <sub>CC</sub> , all R <sub>IN</sub> idle, all T <sub>IN</sub> idle |                        | 1     | 10                    | µA    |   |
| Supply Current, Shutdown   |        | FORCEOFF = GND   |                        | 1     | 10                    | µA    |   |
| Supply Current, AutoShutdown Plus Disabled   |        | FORCEON = FORCEOFF = V <sub>CC</sub> , no load   |                        | 0.3   | 1                     | mA    |   |
| <b>LOGIC INPUTS AND RECEIVER OUTPUTS</b>   |        |  |                        |       |                       |       |   |
| Input Logic Threshold Low  |        | T <sub>IN</sub> , FORCEON, FORCEOFF  |                        |       | 0.8                   | V     |   |
| Input Logic Threshold High   |        | T <sub>IN</sub> , FORCEON, FORCEOFF  | V <sub>CC</sub> = 3.3V | 2     |                       | V     |   |
|  |        |  | V <sub>CC</sub> = 5.0V | 2.4   |                       |       |   |
| Transmitter Input Hysteresis   |        |  |                        | 0.5   |                       | V     |   |
| Input Leakage Current  |        | T <sub>IN</sub> , FORCEON, FORCEOFF  |                        | ±0.01 | ±1                    | µA    |   |
| Output Leakage Current   |        | R <sub>OUT</sub> (MAX3244/MAX3245), receivers disabled   |                        | ±0.05 | ±10                   | µA    |   |
| Output Voltage Low   |        | I <sub>OUT</sub> = 1.6mA   |                        |       | 0.4                   | V     |   |
| Output Voltage High  |        | I <sub>OUT</sub> = -1.0mA  | V <sub>CC</sub> - 0.6  |       | V <sub>CC</sub> - 0.1 | V     |   |
| <b>RECEIVER INPUTS</b>   |        |  |                        |       |                       |       |   |
| Input Voltage Range  |        |  | -25                    |       | +25                   | V     |   |
| Input Threshold Low  |        | T <sub>A</sub> = +25°C   | V <sub>CC</sub> = 3.3V | 0.6   | 1.2                   | V     |   |
|  |        |  | V <sub>CC</sub> = 5.0V | 0.8   | 1.5                   |       |   |
| Input Threshold High   |        | T <sub>A</sub> = +25°C   | V <sub>CC</sub> = 3.3V |       | 1.5                   | 2.4   | V |
|  |        |  | V <sub>CC</sub> = 5.0V |       | 1.8                   | 2.4   |   |
| Input Hysteresis   |        |  |                        | 0.5   |                       | V     |   |
| Input Resistance   |        | T <sub>A</sub> = +25°C   | 3                      | 5     | 7                     | kΩ    |   |

# 1μA Supply Current, 1Mbps, 3.0V to 5.5V, RS-232 Transceivers with AutoShutdown Plus

## ELECTRICAL CHARACTERISTICS (continued)

(V<sub>CC</sub> = +3V to +5.5V, C1–C4 = 0.1μF, tested at 3.3V ±10%; C1 = 0.047μF, C2–C4 = 0.33μF, tested at 5.0V ±10%; T<sub>A</sub> = T<sub>MIN</sub> to T<sub>MAX</sub>, unless otherwise noted. Typical values are at T<sub>A</sub> = +25°C.)

| PARAMETER   | SYMBOL                | CONDITIONS   | MIN                   | TYP  | MAX | UNITS |
|---|-----------------------|--|-----------------------|------|-----|-------|
| <b>TRANSMITTER OUTPUTS</b>  |                       |  |                       |      |     |       |
| Output Voltage Swing  |                       | All transmitter outputs loaded with 3kΩ to ground  | ±5                    | ±5.4 |     | V     |
| Output Resistance   |                       | V <sub>CC</sub> = V <sub>+</sub> = V <sub>-</sub> = 0, transmitter outputs = ±2V                                 | 300                   | 10M  |     | Ω     |
| Output Short-Circuit Current  |                       |  |                       |      | ±60 | mA    |
| Output Leakage Current  |                       | V <sub>CC</sub> = 0 or 3V to 5.5V, V <sub>OUT</sub> = ±12V, Transmitters disabled                                |                       |      | ±25 | μA    |
| <b>MOUSE DRIVEABILITY (MAX3244/MAX3245)</b>                                 |                       |  |                       |      |     |       |
| Transmitter Output Voltage  |                       | T1IN = T2IN = GND, T3IN = V <sub>CC</sub> , T3OUT loaded with 3kΩ to GND, T1OUT and T2OUT loaded with 2.5mA each | ±5                    |      |     | V     |
| <b>AutoShutdown Plus (FORCEON = GND, FORCEOFF = V<sub>CC</sub>)</b>         |                       |  |                       |      |     |       |
| Receiver Input Threshold to $\overline{\text{INVALID}}$ Output High         |                       | Figure 4a  | Positive threshold    |      | 2.7 | V     |
|   |                       |  | Negative threshold    | -2.7 |     |       |
| Receiver Input Threshold to $\overline{\text{INVALID}}$ Output Low          |                       | Figure 4a  | -0.3                  |      | 0.3 | V     |
| $\overline{\text{INVALID}}$ , READY (MAX3224–MAX3227) Output Voltage Low    |                       | I <sub>OUT</sub> = -1.6mA  |                       |      | 0.4 | V     |
| $\overline{\text{INVALID}}$ , READY (MAX3224–MAX3227) Output Voltage High   |                       | I <sub>OUT</sub> = -1.0mA  | V <sub>CC</sub> - 0.6 |      |     | V     |
| Receiver Positive or Negative Threshold to $\overline{\text{INVALID}}$ High | t <sub>INVH</sub>     | V <sub>CC</sub> = 5V, Figure 4b  |                       | 1    |     | μs    |
| Receiver Positive or Negative Threshold to $\overline{\text{INVALID}}$ Low  | t <sub>INVL</sub>     | V <sub>CC</sub> = 5V, Figure 4b  |                       | 30   |     | μs    |
| Receiver or Transmitter Edge to Transmitters Enabled                        | t <sub>WU</sub>       | V <sub>CC</sub> = 5V, Figure 5b (Note 2)   |                       | 100  |     | μs    |
| Receiver or Transmitter Edge to Transmitters Shutdown                       | t <sub>AUTOSHDN</sub> | V <sub>CC</sub> = 5V, Figure 5b (Note 2)   | 15                    | 30   | 60  | s     |

MAX3224–MAX3227/MAX3244/MAX3245

# 1μA Supply Current, 1Mbps, 3.0V to 5.5V, RS-232 Transceivers with AutoShutdown Plus

## TIMING CHARACTERISTICS—MAX3224/MAX3226/MAX3244

( $V_{CC} = +3V$  to  $+5.5V$ ,  $C1-C4 = 0.1\mu F$ , tested at  $3.3V \pm 10\%$ ;  $C1 = 0.047\mu F$ ,  $C2-C4 = 0.33\mu F$ , tested at  $5.0V \pm 10\%$ ;  $T_A = T_{MIN}$  to  $T_{MAX}$ , unless otherwise noted. Typical values are at  $T_A = +25^\circ C$ .)

| PARAMETER                    | SYMBOL                | CONDITIONS  | MIN                       | TYP  | MAX | UNITS     |
|------------------------------|-----------------------|---|---------------------------|------|-----|-----------|
| Maximum Data Rate            |                       | $R_L = 3k\Omega$ , $C_L = 1000pF$ , one transmitter switching   | 250                       |      |     | kbps      |
| Receiver Propagation Delay   | $t_{PHL}$             | $R_{IN}$ to $R_{OUT}$ , $C_L = 150pF$   |                           | 0.15 |     | $\mu s$   |
|                              | $t_{PLH}$             |   |                           | 0.15 |     |           |
| Receiver Output Enable Time  |                       | Normal operation (MAX3244 only)   |                           | 200  |     | ns        |
| Receiver Output Disable Time |                       | Normal operation (MAX3244 only)   |                           | 200  |     | ns        |
| Transmitter Skew             | $ t_{PHL} - t_{PLH} $ | (Note 3)  |                           | 100  |     | ns        |
| Receiver Skew                | $ t_{PHL} - t_{PLH} $ |   |                           | 50   |     | ns        |
| Transition-Region Slew Rate  |                       | $V_{CC} = 3.3V$ , $T_A = +25^\circ C$ , $R_L = 3k\Omega$ to $7k\Omega$ , measured from $+3V$ to $-3V$ or $-3V$ to $+3V$ | $C_L = 150pF$ to $1000pF$ | 6    | 30  | $V/\mu s$ |
|                              |                       |   | $C_L = 150pF$ to $2500pF$ | 4    | 30  |           |

## TIMING CHARACTERISTICS—MAX3225/MAX3227/MAX3245

( $V_{CC} = +3V$  to  $+5.5V$ ,  $C1-C4 = 0.1\mu F$ , tested at  $3.3V \pm 10\%$ ;  $C1 = 0.047\mu F$ ,  $C2-C4 = 0.33\mu F$ , tested at  $5.0V \pm 10\%$ ;  $T_A = T_{MIN}$  to  $T_{MAX}$ , unless otherwise noted. Typical values are at  $T_A = +25^\circ C$ .)

| PARAMETER                    | SYMBOL                | CONDITIONS  | MIN  | TYP  | MAX | UNITS     |
|------------------------------|-----------------------|---|------|------|-----|-----------|
| Maximum Data Rate            |                       | $R_L = 3k\Omega$ , $C_L = 1000pF$ , one transmitter switching   | 250  |      |     | kbps      |
|                              |                       | $V_{CC} = 3.0V$ to $4.5V$ , $R_L = 3k\Omega$ , $C_L = 250pF$ , one transmitter switching  | 1000 |      |     |           |
|                              |                       | $V_{CC} = 4.5V$ to $5.5V$ , $R_L = 3k\Omega$ , $C_L = 1000pF$ , one transmitter switching   | 1000 |      |     |           |
| Receiver Propagation Delay   | $t_{PHL}$             | $R_{IN}$ to $R_{OUT}$ , $C_L = 150pF$   |      | 0.15 |     | $\mu s$   |
|                              | $t_{PLH}$             |   |      | 0.15 |     |           |
| Receiver Output Enable Time  |                       | Normal operation (MAX3245 only)   |      | 200  |     | ns        |
| Receiver Output Disable Time |                       | Normal operation (MAX3245 only)   |      | 200  |     | ns        |
| Transmitter Skew             | $ t_{PHL} - t_{PLH} $ | (Note 3)  |      | 25   |     | ns        |
| Receiver Skew                | $ t_{PHL} - t_{PLH} $ |   |      | 50   |     | ns        |
| Transition-Region Slew Rate  |                       | $V_{CC} = 3.3V$ , $T_A = +25^\circ C$ , $R_L = 3k\Omega$ to $7k\Omega$ , $C_L = 150pF$ to $1000pF$ , measured from $+3V$ to $-3V$ or $-3V$ to $+3V$ | 24   |      | 150 | $V/\mu s$ |

**Note 2:** A transmitter/receiver edge is defined as a transition through the transmitter/receiver input logic thresholds.

**Note 3:** Transmitter skew is measured at the transmitter zero cross points.

# 1 $\mu$ A Supply Current, 1Mbps, 3.0V to 5.5V, RS-232 Transceivers with AutoShutdown Plus

## Typical Operating Characteristics

( $V_{CC} = +3.3V$ , 250kbps data rate,  $C_1-C_4 = 0.1\mu F$ , all transmitters loaded with  $3k\Omega$  and  $C_L$ ,  $T_A = +25^\circ C$ , unless otherwise noted.)

MAX3224-MAX3227/MAX3244/MAX3245

**MAX3224/MAX3226**  
TRANSMITTER OUTPUT VOLTAGE  
vs. LOAD CAPACITANCE

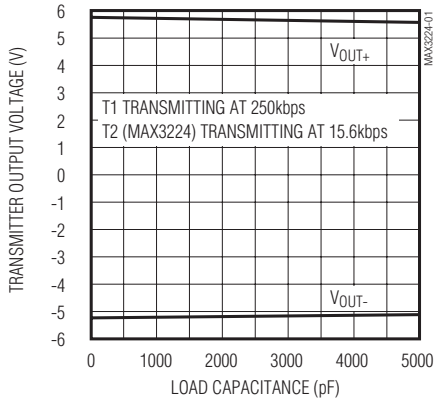

**MAX3224/MAX3226**  
SLEW RATE vs. LOAD CAPACITANCE

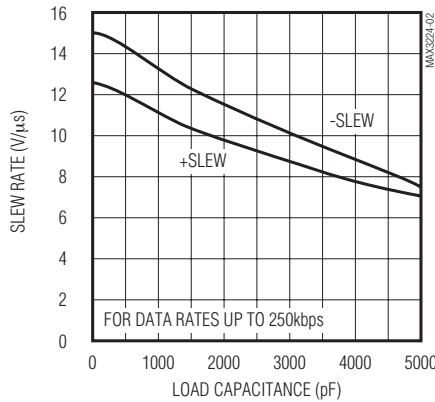

**MAX3224/MAX3226**  
OPERATING SUPPLY CURRENT  
vs. LOAD CAPACITANCE

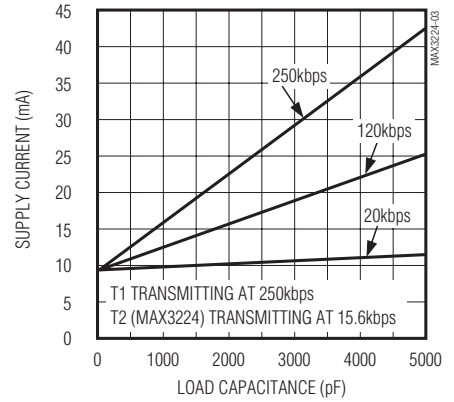

**MAX3225/MAX3227**  
TRANSMITTER OUTPUT VOLTAGE  
vs. LOAD CAPACITANCE

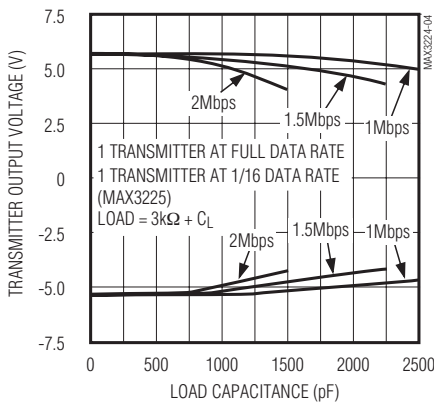

**MAX3225/MAX3227**  
SLEW RATE vs. LOAD CAPACITANCE

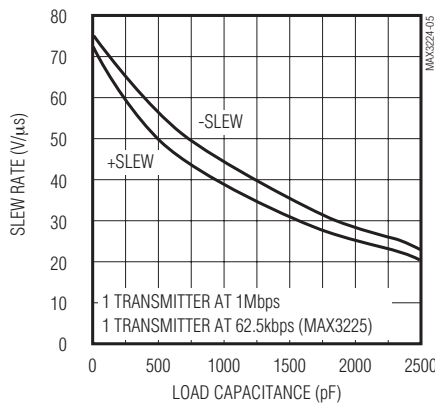

**MAX3225/MAX3227**  
OPERATING SUPPLY CURRENT  
vs. LOAD CAPACITANCE

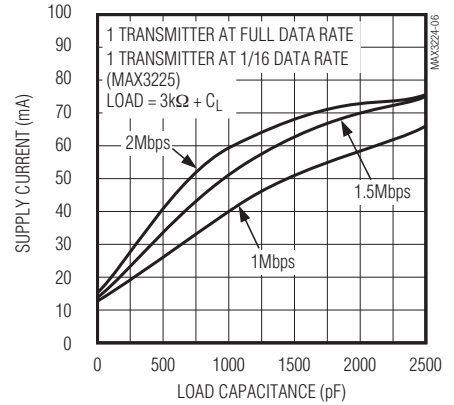

**MAX3225/MAX3227**  
TRANSMITTER SKEW vs.  
LOAD CAPACITANCE

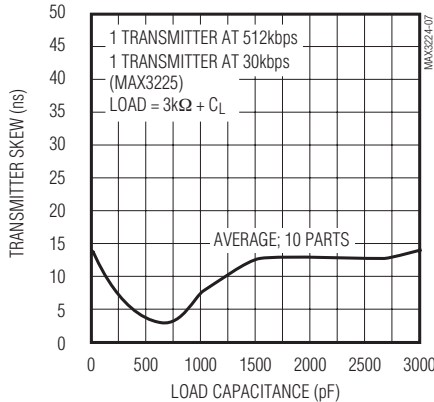

**MAX3224-MAX3227**  
READY TURN-ON TIME  
vs. TEMPERATURE

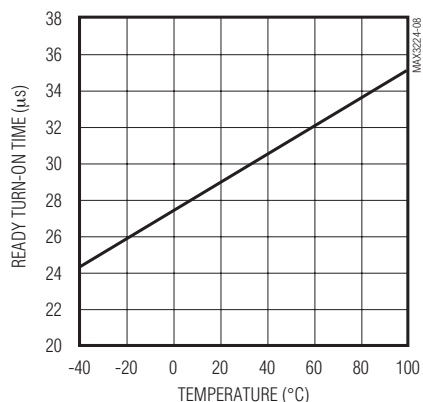

**MAX3224-MAX3227**  
READY TURN-OFF TIME  
vs. TEMPERATURE

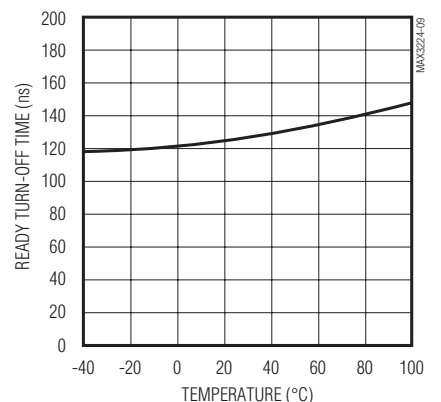

# 1μA Supply Current, 1Mbps, 3.0V to 5.5V, RS-232 Transceivers with AutoShutdown Plus

## Typical Operating Characteristics (continued)

( $V_{CC} = +3.3V$ , 250kbps data rate, C1–C4 = 0.1μF, all transmitters loaded with 3kΩ and  $C_L$ ,  $T_A = +25^\circ C$ , unless otherwise noted.)

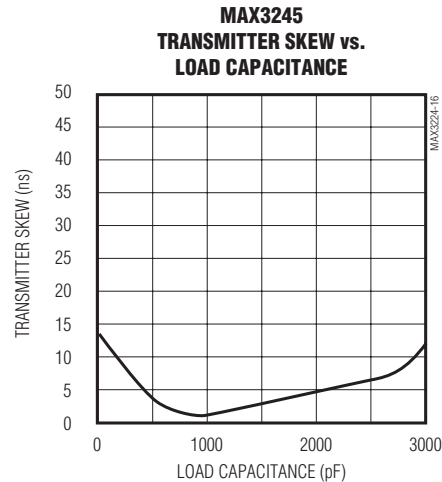
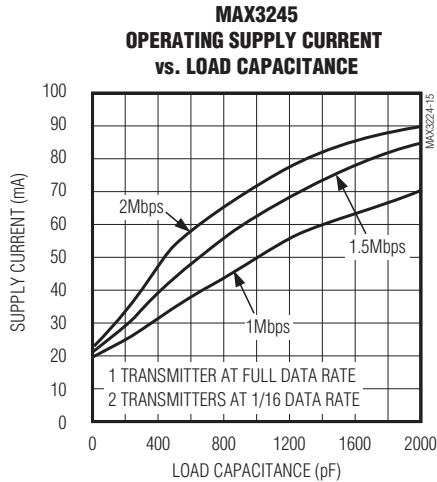
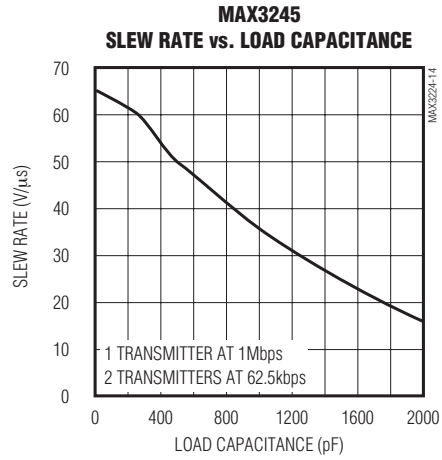
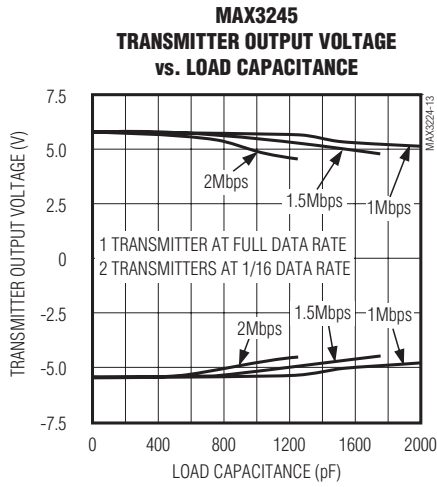
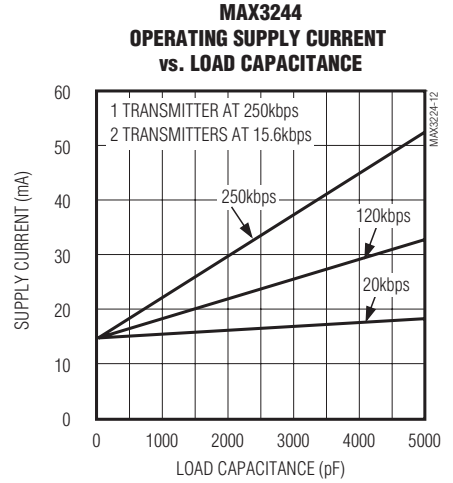
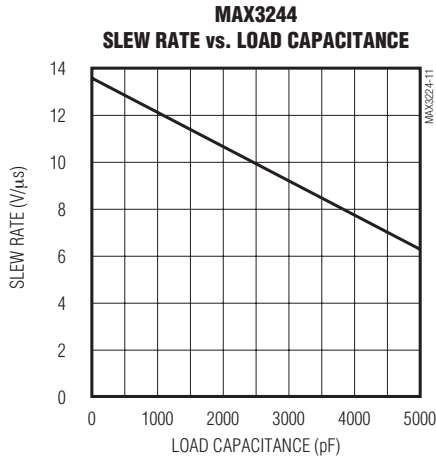
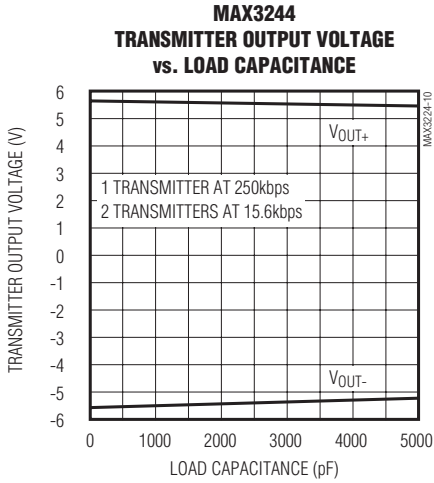

# 1µA Supply Current, 1Mbps, 3.0V to 5.5V, RS-232 Transceivers with AutoShutdown Plus

## Pin Description

| PIN                     |             |                    |                    | NAME                         | FUNCTION  |
|-------------------------|-------------|--------------------|--------------------|------------------------------|---|
| MAX3224<br>MAX3225      |             | MAX3226<br>MAX3227 | MAX3244<br>MAX3245 |                              |   |
| PDIP/<br>SSIP/<br>TSSOP | TQFN-<br>EP |                    |                    |                              |   |
| 1                       | 19          | 1                  | —                  | READY                        | Ready to Transmit Output, Active High. READY is enabled high when V- goes below -4V and the device is ready to transmit.  |
| 2                       | 1           | 2                  | 28                 | C1+                          | Positive Terminal of Voltage-Doubler Charge-Pump Capacitor  |
| 3                       | 20          | 3                  | 27                 | V+                           | +5.5V Generated By the Charge Pump  |
| 4                       | 2           | 4                  | 24                 | C1-                          | Negative Terminal of Voltage-Doubler Charge-Pump Capacitor  |
| 5                       | 3           | 5                  | 1                  | C2+                          | Positive Terminal of Inverting Charge-Pump Capacitor  |
| 6                       | 4           | 6                  | 2                  | C2-                          | Negative Terminal of Inverting Charge-Pump Capacitor  |
| 7                       | 5           | 7                  | 3                  | V-                           | -5.5V Generated By the Charge Pump  |
| 8, 17                   | 6, 15       | 13                 | 9, 10, 11          | T_OUT                        | RS-232 Transmitter Outputs  |
| 9, 16                   | 7, 14       | 8                  | 4–8                | R_IN                         | RS-232 Receiver Inputs  |
| 10, 15                  | 8, 13       | 9                  | 15–19              | R_OUT                        | TTL/CMOS Receiver Outputs   |
| 11                      | 9           | 10                 | 21                 | $\overline{\text{INVALID}}$  | Valid Signal Detector Output, Active Low. A logic-high indicates that a valid RS-232 level is present on a receiver input.  |
| 12, 13                  | 10, 11      | 11                 | 12, 13, 14         | T_IN                         | TTL/CMOS Transmitter Inputs   |
| 14                      | 12          | 12                 | 23                 | FORCEON                      | Force-On Input, Active High. Drive high to override AutoShutdown Plus, keeping transmitters and receivers on ( $\overline{\text{FORCEOFF}}$ must be high) (Table 1).  |
| 18                      | 16          | 14                 | 25                 | GND                          | Ground  |
| 19                      | 17          | 15                 | 26                 | VCC                          | +3.0V to +5.5V Single Supply Voltage  |
| 20                      | 18          | 16                 | 22                 | $\overline{\text{FORCEOFF}}$ | Force-Off Input, Active Low. Drive low to shut down transmitters, receivers (except R2OUTB), and charge pump. This overrides AutoShutdown Plus and FORCEON (Table 1). |
| —                       | —           | —                  | 20                 | R2OUTB                       | TTL/CMOS Noninverting Complementary Receiver Outputs. Always active.  |
| —                       | —           | —                  | —                  | EP                           | Exposed Pad (TQFN only). Solder the exposed pad to the ground, or leave unconnected.  |

MAX3224-MAX3227/MAX3244/MAX3245

## Detailed Description

### Dual Charge-Pump Voltage Converter

The MAX3224-MAX3227/MAX3244/MAX3245's internal power supply consists of a regulated dual charge pump that provides output voltages of +5.5V (doubling charge pump) and -5.5V (inverting charge pump), over the +3.0V to +5.5V range. The charge pump operates in discontinuous mode: if the output voltages are less

than 5.5V, the charge pump is enabled; if the output voltages exceed 5.5V, the charge-pump is disabled. Each charge pump requires a flying capacitor (C1, C2) and a reservoir capacitor (C3, C4) to generate the V+ and V- supplies.

The READY output (MAX3224-MAX3227) is low when the charge pumps are disabled in shutdown mode. The READY signal asserts high when V- goes below -4V.



# 1µA Supply Current, 1Mbps, 3.0V to 5.5V, RS-232 Transceivers with AutoShutdown Plus

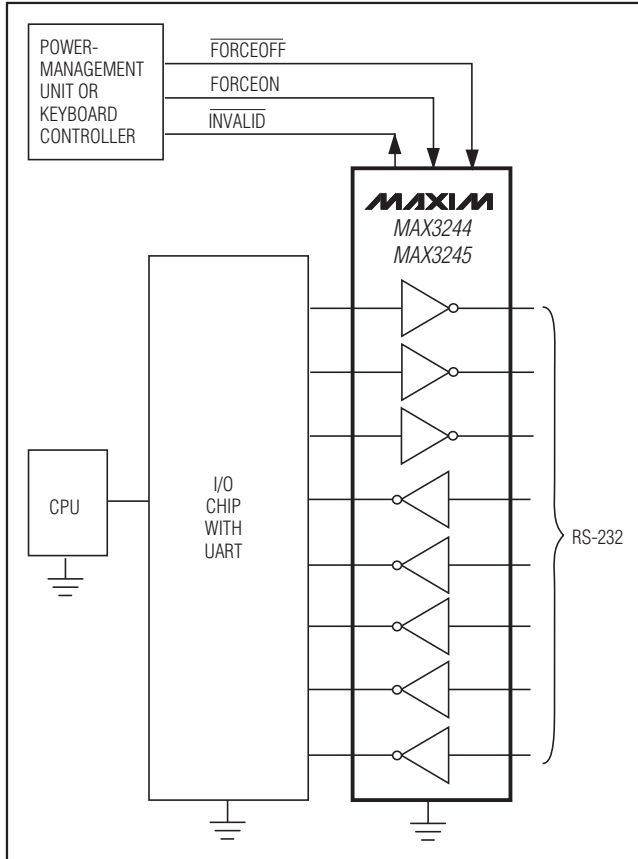

Figure 1. Interface Under Control of PMU

### RS-232 Transmitters

The transmitters are inverting level translators that convert CMOS-logic levels to 5.0V EIA/TIA-232 levels. The MAX3224/MAX3226/MAX3244 guarantee a 250kbps data rate (1Mbps for the MAX3225/MAX3227/MAX3245) with worst-case loads of 3kΩ in parallel with 1000pF, providing compatibility with PC-to-PC communication software (such as LapLink®). Transmitters can be paralleled to drive multiple receivers. Figure 1 shows a complete system connection.

When  $\overline{\text{FORCEOFF}}$  is driven to ground or when the Auto-Shutdown Plus circuitry senses that all receiver and transmitter inputs are inactive for more than 30sec, the transmitters are disabled and the outputs go into a high-impedance state. When powered off or shut down, the outputs can be driven to  $\pm 12\text{V}$ . The transmitter inputs do not have pull-up resistors. Connect unused inputs to GND or VCC.

LapLink is a registered trademark of Laplink Software, Inc.

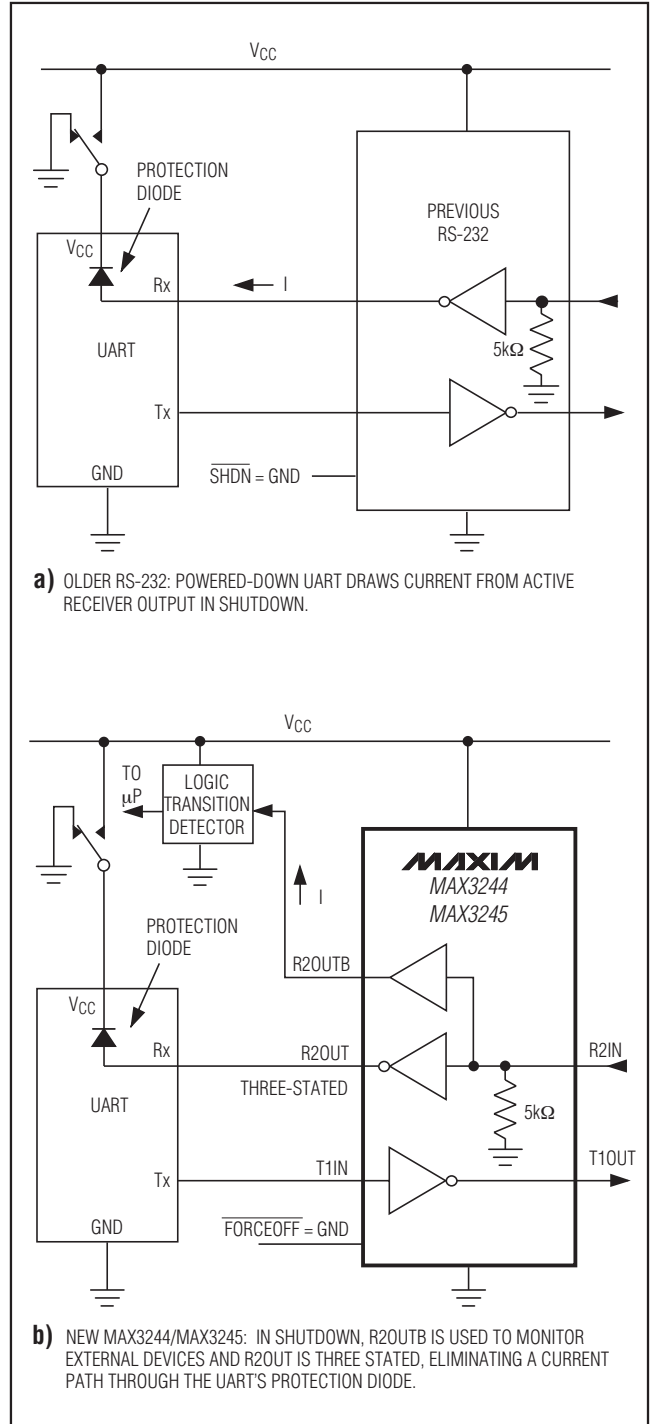

Figure 2. The MAX3244/MAX3245 detect RS-232 activity when the UART and interface are shut down.



# 1µA Supply Current, 1Mbps, 3.0V to 5.5V, RS-232 Transceivers with AutoShutdown Plus

MAX3224-MAX3227/MAX3244/MAX3245

**Table 1. Output Control Truth Table**

| OPERATION STATUS                     | FORCEON                       | $\overline{\text{FORCEOFF}}$     | VALID RECEIVER LEVEL | RECEIVER OR TRANSMITTER EDGE WITHIN 30sec | T_OUT  | R_OUT (MAX3224/MAX3225/MAX3226/MAX3227) | R_OUT (MAX3244/MAX3245) | R2OUTB (MAX3244/MAX3245) |
|--------------------------------------|-------------------------------|----------------------------------|----------------------|---|--------|---|-------------------------|--------------------------|
| Shutdown (Forced Off)                | X                             | 0                                | X                    | X   | High-Z | Active                                  | High-Z                  | Active                   |
| Normal Operation (Forced On)         | 1                             | 1                                | X                    | X   | Active | Active                                  | Active                  | Active                   |
| Normal Operation (AutoShutdown Plus) | 0                             | 1                                | X                    | Yes                                       | Active | Active                                  | Active                  | Active                   |
| Shutdown (Auto-Shutdown Plus)        | 0                             | 1                                | X                    | No  | High-Z | Active                                  | Active                  | Active                   |
| Normal Operation                     | $\overline{\text{INVALID}}^*$ | 1                                | Yes                  | X   | Active | Active                                  | Active                  | Active                   |
| Normal Operation                     | $\overline{\text{INVALID}}^*$ | 1                                | X                    | Yes                                       | Active | Active                                  | Active                  | Active                   |
| Shutdown                             | $\overline{\text{INVALID}}^*$ | 1                                | No                   | No  | High-Z | Active                                  | Active                  | Active                   |
| Normal Operation (AutoShutdown)      | $\overline{\text{INVALID}}^*$ | $\overline{\text{INVALID}}^{**}$ | Yes                  | X   | Active | Active                                  | Active                  | Active                   |
| Shutdown (AutoShutdown™)             | $\overline{\text{INVALID}}^*$ | $\overline{\text{INVALID}}^{**}$ | No                   | X   | High-Z | Active                                  | High-Z                  | Active                   |

X = Don't care

\* $\overline{\text{INVALID}}$  connected to FORCEON

\*\* $\overline{\text{INVALID}}$  connected to FORCEON and  $\overline{\text{FORCEOFF}}$

## RS-232 Receivers

The receivers convert RS-232 signals to CMOS-logic output levels. The MAX3224-MAX3227 feature inverting outputs that always remain active (Table 1). The MAX3244/MAX3245 have inverting three-state outputs that are high impedance when shut down ( $\overline{\text{FORCEOFF}}$  = GND) (Table 1).

The MAX3244/MAX3245 feature an extra, always active, noninverting output, R2OUTB. R2OUTB output monitors receiver activity while the other receivers are high impedance, allowing Ring Indicator applications to be monitored without forward biasing other devices connected to the receiver outputs. This is ideal for systems where  $V_{CC}$  is set to ground in shutdown to accommodate peripherals such as UARTs (Figure 2).

AutoShutdown is a trademark of Maxim Integrated Products, Inc.

The MAX3224-MAX3227/MAX3244/MAX3245 feature an  $\overline{\text{INVALID}}$  output that is enabled low when no valid RS-232 voltage levels have been detected on all receiver inputs. Because  $\overline{\text{INVALID}}$  indicates the receiver input's condition, it is independent of FORCEON and  $\overline{\text{FORCEOFF}}$  states (Figures 3 and 4).

## AutoShutdown Plus Mode

The MAX3224-MAX3227/MAX3244/MAX3245 achieve a 1µA supply current with Maxim's AutoShutdown Plus feature, which operates when  $\overline{\text{FORCEOFF}}$  is high and a FORCEON is low. When these devices do not sense a valid signal transition on any receiver and transmitter input for 30sec, the on-board charge pumps are shut down, reducing supply current to 1µA. This occurs if the RS-232 cable is disconnected or if the connected

# 1µA Supply Current, 1Mbps, 3.0V to 5.5V, RS-232 Transceivers with AutoShutdown Plus

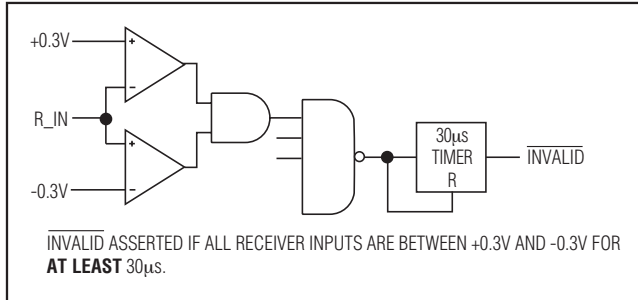

Figure 3a.  $\overline{\text{INVALID}}$  Functional Diagram,  $\overline{\text{INVALID}}$  Low

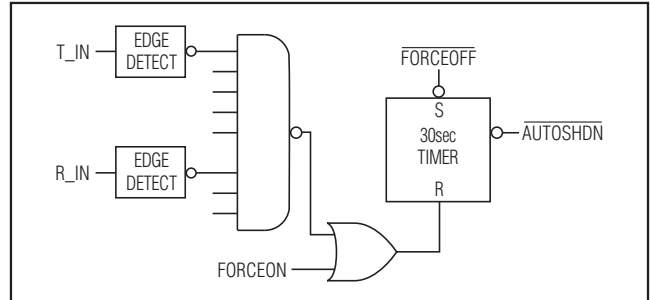

Figure 3c. AutoShutdown Plus Logic

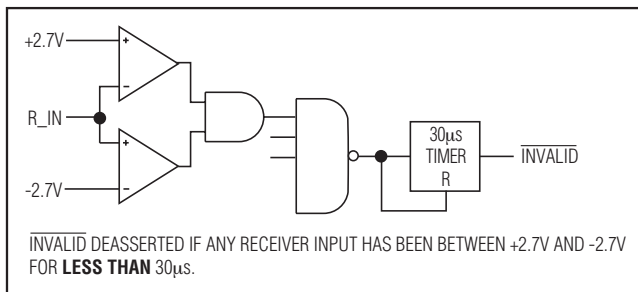

Figure 3b.  $\overline{\text{INVALID}}$  Functional Diagram,  $\overline{\text{INVALID}}$  High

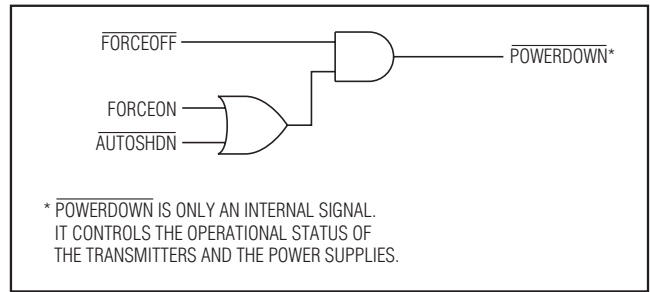

Figure 3d. Power-Down Logic

**Table 2.  $\overline{\text{INVALID}}$  Truth Table**

| RS-232 SIGNAL PRESENT AT ANY RECEIVER INPUT | $\overline{\text{INVALID}}$ OUTPUT |
|---|------------------------------------|
| Yes   | High                               |
| No  | Low                                |

peripheral transmitters are turned off, and the UART driving the transmitter inputs is inactive. The system turns on again when a valid transition is applied to any RS-232 receiver or transmitter input. As a result, the system saves power without changes to the existing BIOS or operating system.

Figures 3a and 3b depict valid and invalid RS-232 receiver voltage levels.  $\overline{\text{INVALID}}$  indicates the receiver input's condition, and is independent of FORCEON and FORCEOFF states. Figure 3 and Tables 1 and 2 summarize the operating modes of the MAX3224-MAX3227/MAX3244/MAX3245 devices. FORCEON and FORCEOFF override AutoShutdown Plus circuitry. When neither control is asserted, the IC selects

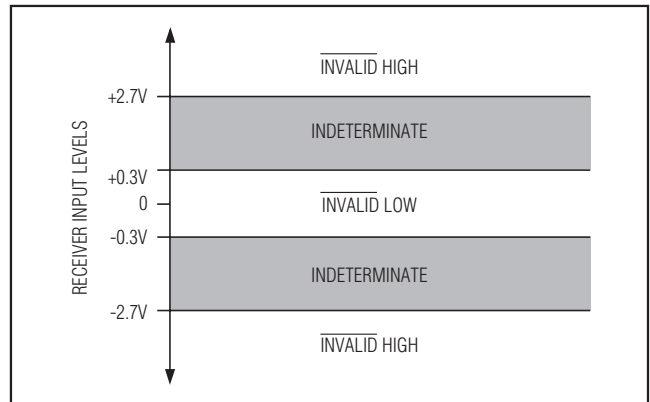

Figure 4a. Receiver Positive/Negative Thresholds for  $\overline{\text{INVALID}}$

between these states automatically based on the last receiver or transmitter input edge received.

When shut down, the device's charge pumps turn off, V+ is pulled to VCC, V- is pulled to ground, the transmitter outputs are high impedance, and READY (MAX3224-MAX3227) is driven low. The time required to exit shutdown is typically 100µs (Figure 6).

# 1 $\mu$ A Supply Current, 1Mbps, 3.0V to 5.5V, RS-232 Transceivers with AutoShutdown Plus

MAX3224-MAX3227/MAX3244/MAX3245

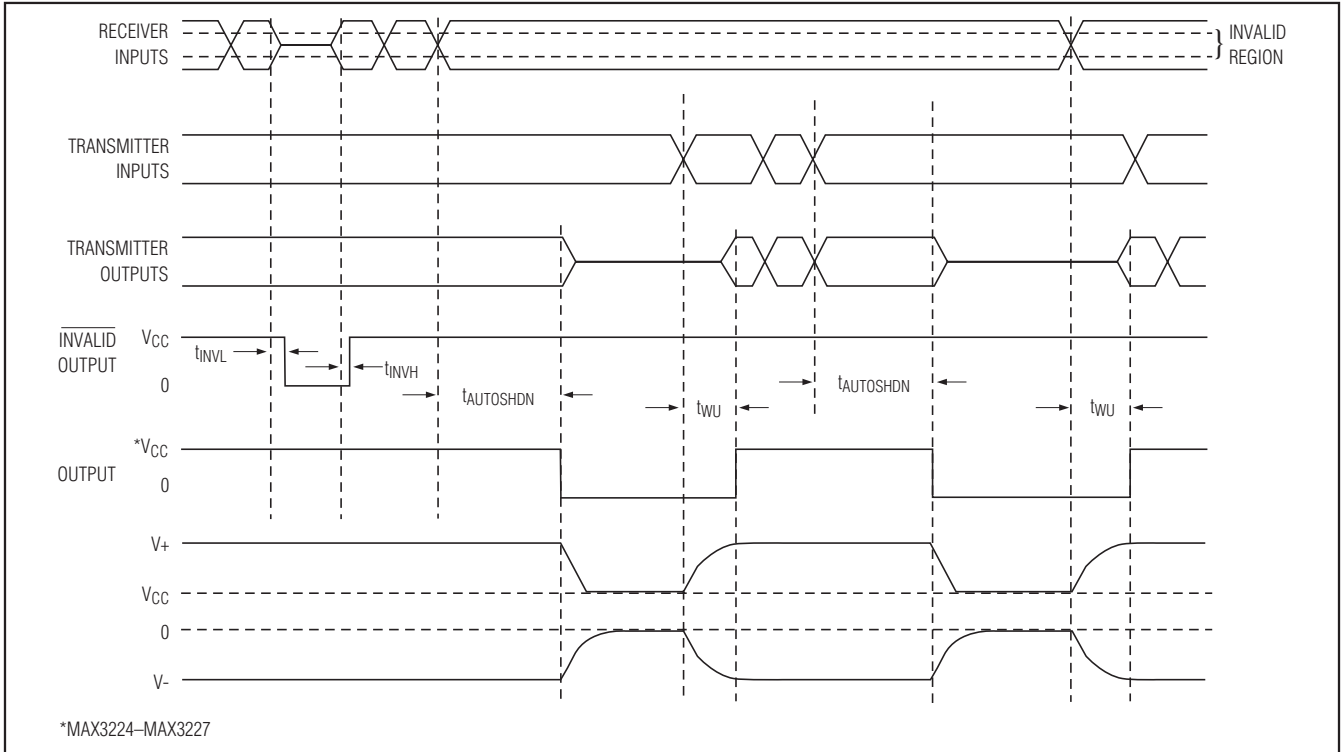

Figure 4b. AutoShutdown Plus,  $\overline{\text{INVALID}}$ , and  $\overline{\text{READY}}$  Timing Diagram

By connecting FORCEON to  $\overline{\text{INVALID}}$ , the MAX3224-MAX3227/MAX3244/MAX3245 shut down when no valid receiver level and no receiver or transmitter edge is detected for 30sec, and wake up when a valid receiver level or receiver or transmitter edge is detected.

By connecting FORCEON and  $\overline{\text{FORCEOFF}}$  to  $\overline{\text{INVALID}}$ , the MAX3224-MAX3227/MAX3244/MAX3245 shutdown when no valid receiver level is detected and wake up when a valid receiver level is detected (same functionality as AutoShutdown feature on MAX3221/MAX3223/MAX3243).

A mouse or other system with AutoShutdown Plus may need time to wake up. Figure 5 shows a circuit that forces the transmitters on for 100ms, allowing enough time for the other system to realize that the MAX3244/MAX3245 is awake. If the other system outputs valid RS-232 signal transitions within that time, the RS-232 ports on both systems remain enabled.

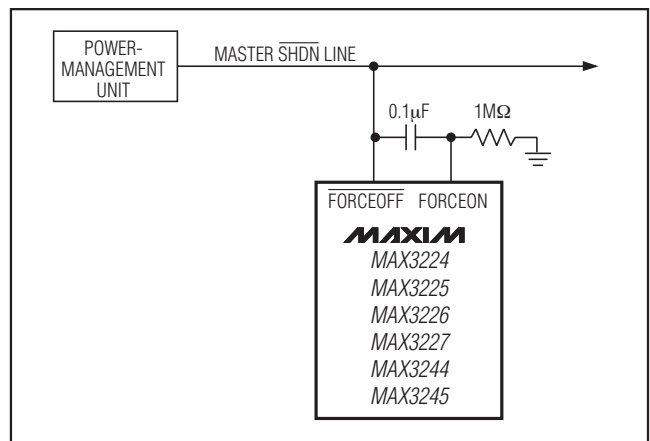

Figure 5. AutoShutdown Plus Initial Turn-On to Wake Up a Mouse or Another System

# 1µA Supply Current, 1Mbps, 3.0V to 5.5V, RS-232 Transceivers with AutoShutdown Plus

## Software-Controlled Shutdown

If direct software control is desired, use  $\overline{\text{INVALID}}$  to indicate DTR or Ring Indicator signal. Tie  $\overline{\text{FORCEOFF}}$  and  $\overline{\text{FORCEON}}$  together to bypass the AutoShutdown Plus so the line acts like a SHDN input.

## Applications Information

### Capacitor Selection

The capacitor type used for C1–C4 is not critical for proper operation; polarized or nonpolarized capacitors can be used. The charge pump requires 0.1µF capacitors for 3.3V operation. For other supply voltages, see Table 3 for required capacitor values. Do not use values smaller than those listed in Table 3. Increasing the capacitor values (e.g., by a factor of 2) reduces ripple on the transmitter outputs and slightly reduces power consumption. C2, C3, and C4 can be increased without changing C1's value. **However, do not increase C1 without also increasing the values of C2, C3, C4, and CBYPASS, to maintain the proper ratios (C1 to the other capacitors).**

When using the minimum required capacitor values, make sure the capacitor value does not degrade excessively with temperature. If in doubt, use capacitors with a larger nominal value. The capacitor's equivalent series resistance (ESR), which usually rises at low temperatures, influences the amount of ripple on V+ and V-.

### Power-Supply Decoupling

In most circumstances, a 0.1µF VCC bypass capacitor is adequate. In applications that are sensitive to power-supply noise, use a capacitor of the same value as charge-pump capacitor C1. Connect bypass capacitors as close to the IC as possible.

### Transmitter Outputs when Exiting Shutdown

Figure 6 shows two transmitter outputs when exiting shutdown mode. As they become active, the two transmitter outputs are shown going to opposite RS-232 levels (one transmitter input is high; the other is low). Each

**Table 3. Required Minimum Capacitance Values**

| VCC (V)    | C1, CBYPASS (µF) | C2, C3, C4 (µF) |
|------------|------------------|-----------------|
| 3.0 to 3.6 | 0.1              | 0.1             |
| 4.5 to 5.5 | 0.047            | 0.33            |
| 3.0 to 5.5 | 0.22             | 1               |

transmitter is loaded with 3kΩ in parallel with 1000pF. The transmitter outputs display no ringing or undesirable transients as they come out of shutdown. Note that the transmitters are enabled only when the magnitude of V- exceeds approximately -3V.

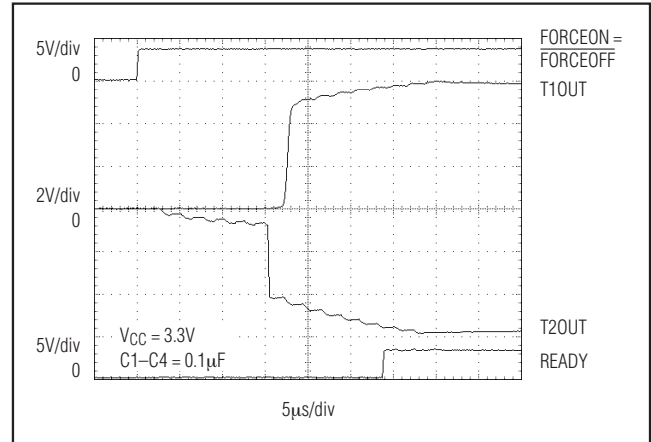

Figure 6. Transmitter Outputs when Exiting Shutdown or Powering Up

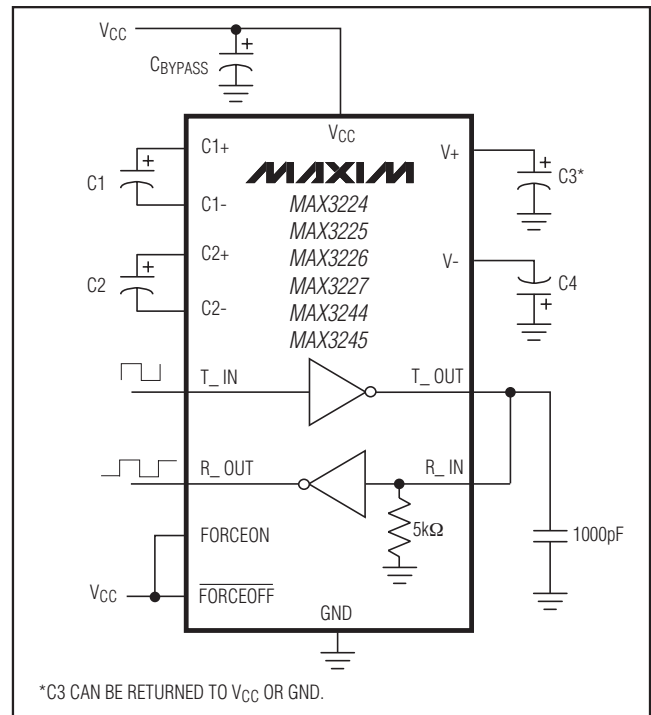

Figure 7. Loopback Test Circuit

# 1 $\mu$ A Supply Current, 1Mbps, 3.0V to 5.5V, RS-232 Transceivers with AutoShutdown Plus

MAX3224-MAX3227/MAX3244/MAX3245

## High Data Rates

The MAX3224/MAX3226/MAX3244 maintain the RS-232  $\pm 5.0V$  minimum transmitter output voltage even at high data rates. Figure 7 shows a transmitter loopback test circuit. Figure 8 shows a loopback test result at 120kbps, and Figure 9 shows the same test at 250kbps. For Figure 8, all transmitters were driven simultaneously at 120kbps into RS-232 loads in parallel with 1000pF. For Figure 9, a single transmitter was driven at 250kbps, and all transmitters were loaded with an RS-232 receiver in parallel with 250pF.

The MAX3225/MAX3227/MAX3245 maintain the RS-232  $\pm 5.0V$  minimum transmitter output voltage at data rates up to 1Mbps (MegaBaud). Figure 10 shows a loopback test result with a single transmitter driven at 1Mbps and all transmitters loaded with an RS-232 receiver in parallel with 250pF.

## Mouse Driveability

The MAX3244/MAX3245 are specifically designed to power serial mice while operating from low-voltage power supplies. They have been tested with leading mouse brands from manufacturers such as Microsoft and Logitech. The MAX3244/MAX3245 successfully

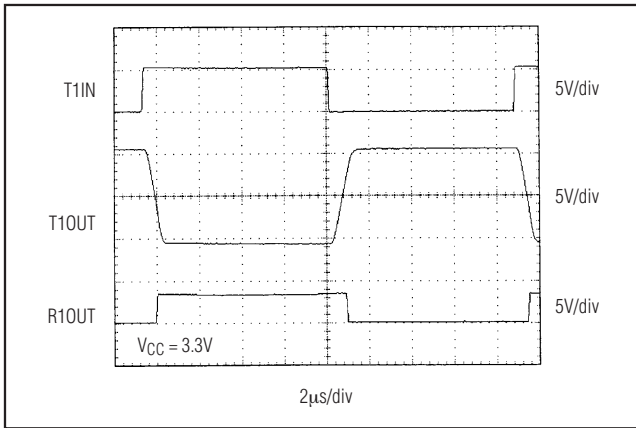

Figure 8. MAX3224/MAX3226/MAX3244 Loopback Test Result at 120kbps

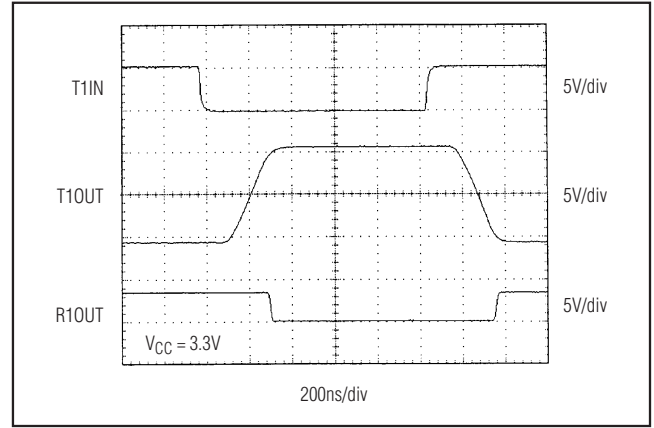

Figure 10. MAX3225/MAX3227/MAX3245 Loopback Test Result at 1Mbps

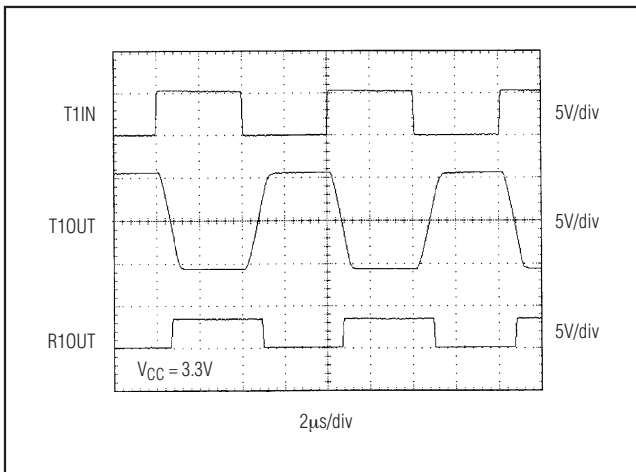

Figure 9. MAX3224/MAX3226/MAX3244 Loopback Test Result at 250kbps

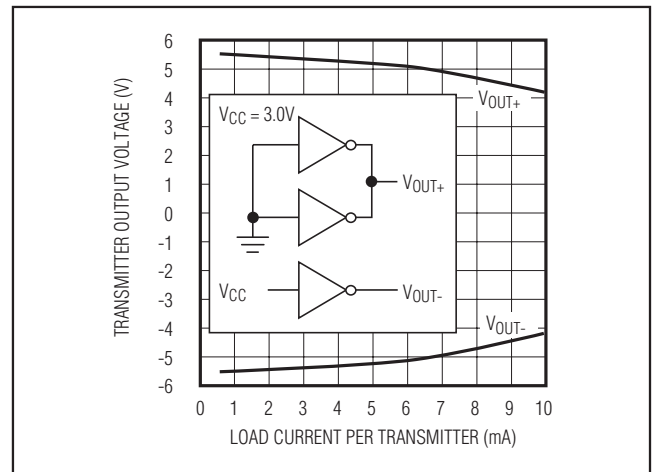

Figure 11a. MAX324\_ Transmitter Output Voltage vs. Load Current per Transmitter

# 1µA Supply Current, 1Mbps, 3.0V to 5.5V, RS-232 Transceivers with AutoShutdown Plus

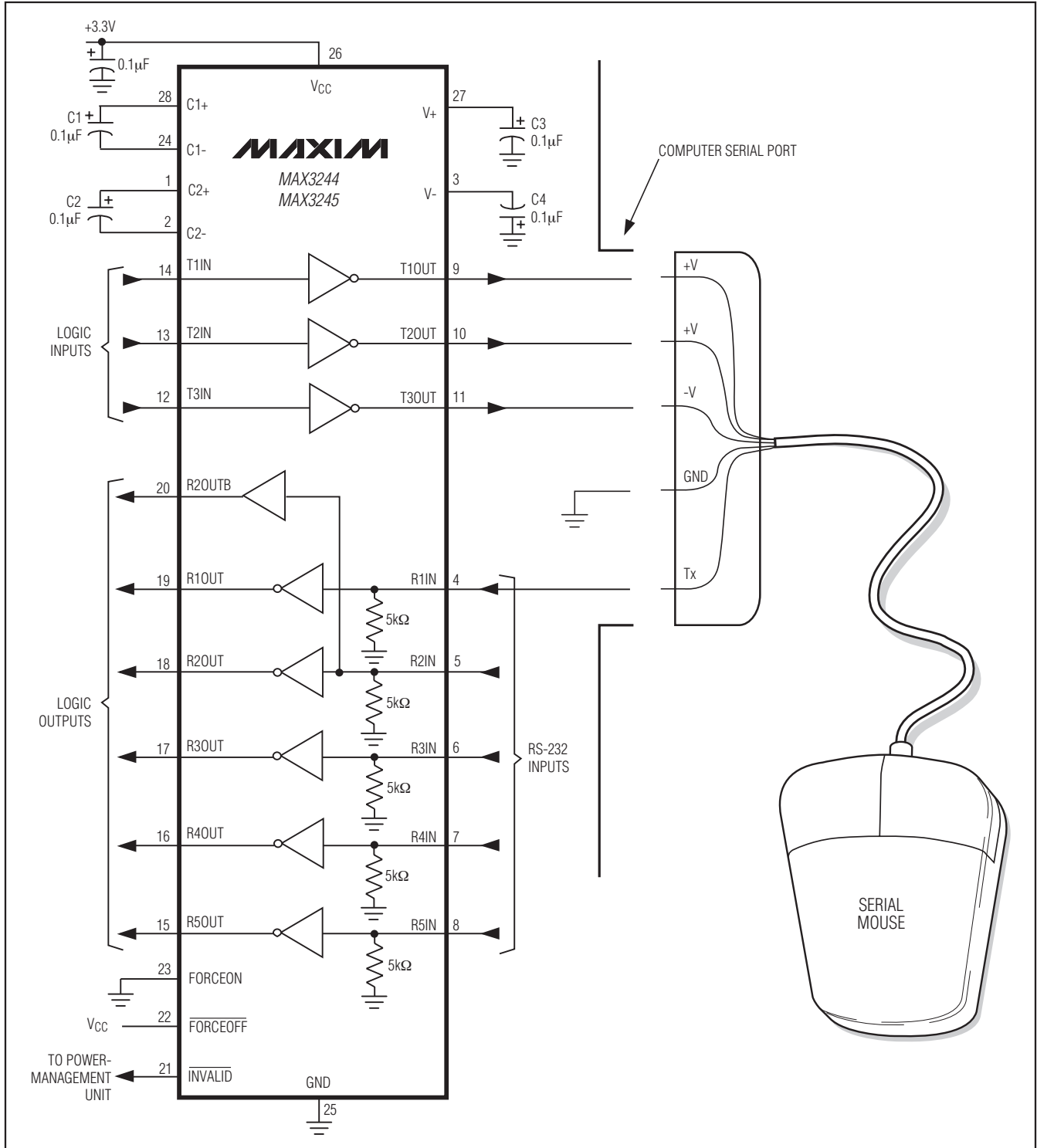

Figure 11b. Mouse Driver Test Circuit

# 1 $\mu$ A Supply Current, 1Mbps, 3.0V to 5.5V, RS-232 Transceivers with AutoShutdown Plus

drove all serial mice tested and met their respective current and voltage requirements. The MAX3244/MAX3245 dual charge pump ensures the transmitters will supply at least  $\pm 5V$  during worst-case conditions. Figure 11a shows the transmitter output voltages under increasing load current. Figure 11b shows a typical mouse connection.

## Interconnection with 3V and 5V Logic

The MAX3224–MAX3227/MAX3244/MAX3245 can directly interface with various 5V logic families, including ACT and HCT CMOS. See Table 4 for more information on possible combinations of interconnections.

Table 5 lists other Maxim 3.0V to 5.5V powered transceivers.

**Table 4. Logic Family Compatibility with Various Supply Voltages**

| SYSTEM POWER-SUPPLY VOLTAGE (V) | V <sub>CC</sub> SUPPLY VOLTAGE (V) | COMPATIBILITY   |
|---------------------------------|------------------------------------|---|
| 3.3                             | 3.3                                | Compatible with all CMOS families                                 |
| 5                               | 5                                  | Compatible with all TTL and CMOS families                         |
| 5                               | 3.3                                | Compatible with ACT and HCT CMOS, and with AC, HC, or CD4000 CMOS |

**Table 5. 3.0V to 5.5V Powered RS-232 Transceivers from Maxim**

| PART    | SUPPLY VOLTAGE RANGE (V) | NO. OF Tx/Rx | SUPPLY CURRENT ( $\mu$ A) | Auto-Shutdown Plus | Auto-Shutdown | GUARANTEED DATA RATE (bps) |
|---------|--------------------------|--------------|---------------------------|--------------------|---------------|----------------------------|
| MAX3241 | +3.0 to +5.5             | 3/5          | 300                       | —                  | —             | 120k                       |
| MAX3243 | +3.0 to +5.5             | 3/5          | 1                         | —                  | Yes           | 120k                       |
| MAX3244 | +3.0 to +5.5             | 3/5          | 1                         | Yes                | —             | 250k                       |
| MAX3245 | +3.0 to +5.5             | 3/5          | 1                         | Yes                | —             | 1M                         |
| MAX3232 | +3.0 to +5.5             | 2/2          | 300                       | —                  | —             | 120k                       |
| MAX3222 | +3.0 to +5.5             | 2/2          | 300                       | —                  | —             | 120k                       |
| MAX3223 | +3.0 to +5.5             | 2/2          | 1                         | —                  | Yes           | 120k                       |
| MAX3224 | +3.0 to +5.5             | 2/2          | 1                         | Yes                | —             | 250k                       |
| MAX3225 | +3.0 to +5.5             | 2/2          | 1                         | Yes                | —             | 1M                         |
| MAX3221 | +3.0 to +5.5             | 1/1          | 1                         | —                  | Yes           | 120k                       |
| MAX3226 | +3.0 to +5.5             | 1/1          | 1                         | Yes                | —             | 250k                       |
| MAX3227 | +3.0 to +5.5             | 1/1          | 1                         | Yes                | —             | 1M                         |

MAX3224–MAX3227/MAX3244/MAX3245



# 1µA Supply Current, 1Mbps, 3.0V to 5.5V, RS-232 Transceivers with AutoShutdown Plus

## Typical Operating Circuits

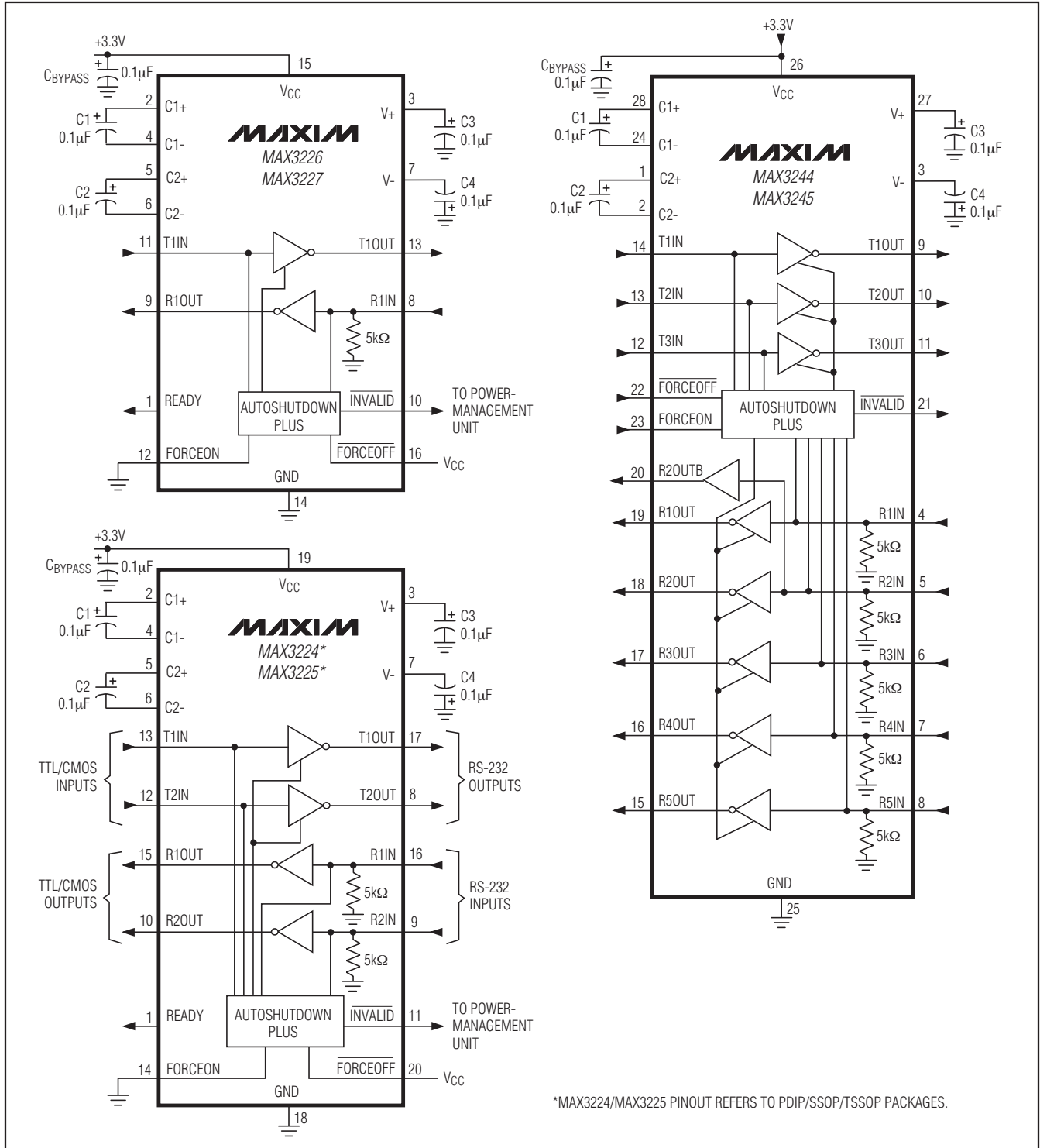

# 1µA Supply Current, 1Mbps, 3.0V to 5.5V, RS-232 Transceivers with AutoShutdown Plus

## Pin Configurations

MAX3224-MAX3227/MAX3244/MAX3245

TOP VIEW

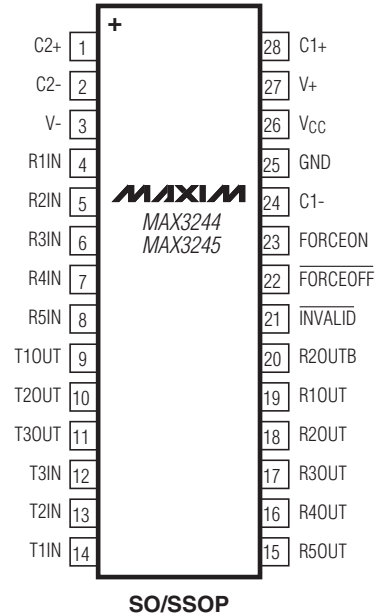
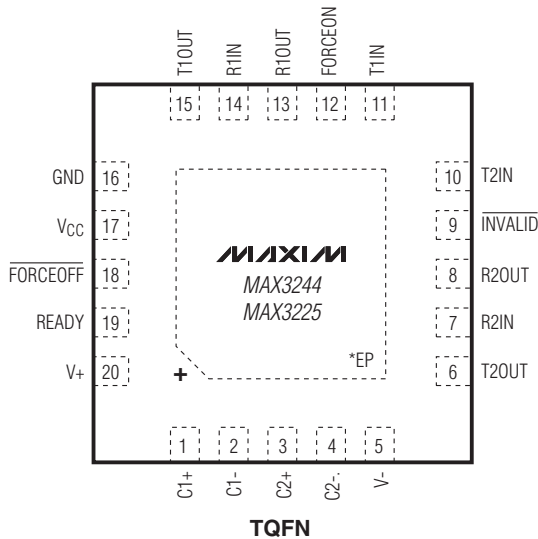
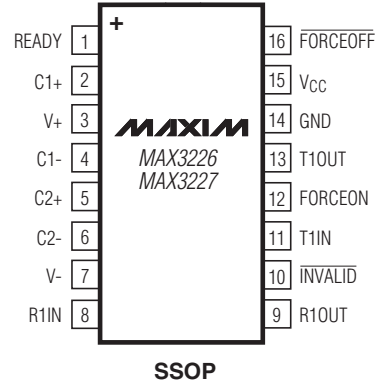
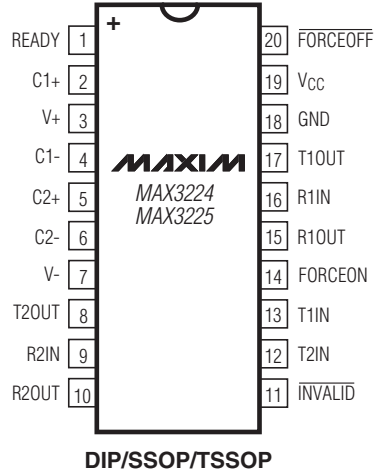

# 1µA Supply Current, 1Mbps, 3.0V to 5.5V, RS-232 Transceivers with AutoShutdown Plus

## Ordering Information (continued)

| PART                | TEMP RANGE     | PIN-PACKAGE |
|---------------------|----------------|-------------|
| <b>MAX3225</b> CPP+ | 0°C to +70°C   | 20 PDIP     |
| MAX3225CAP+         | 0°C to +70°C   | 20 SSOP     |
| MAX3225CTP+         | 0°C to +70°C   | 20 TQFN-EP* |
| MAX3225CUP+         | 0°C to +70°C   | 20 TSSOP    |
| MAX3225EPP+         | -40°C to +85°C | 20 PDIP     |
| MAX3225EAP+         | -40°C to +85°C | 20 SSOP     |
| MAX3225ETP+         | -40°C to +85°C | 20 TQFN-EP* |
| MAX3225EUP+         | -40°C to +85°C | 20 TSSOP    |
| MAX3225EUP/V+       | -40°C to +85°C | 20 TSSOP    |
| <b>MAX3226</b> CAE+ | 0°C to +70°C   | 16 SSOP     |
| MAX3226EAE+         | -40°C to +85°C | 16 SSOP     |
| <b>MAX3227</b> CAE+ | 0°C to +70°C   | 16 SSOP     |
| MAX3227EAE+         | -40°C to +85°C | 16 SSOP     |
| <b>MAX3244</b> CWI+ | 0°C to +70°C   | 28 SO (W)   |
| MAX3244CAI+         | 0°C to +70°C   | 28 SSOP     |
| MAX3244EWI+         | -40°C to +85°C | 28 SO (W)   |
| MAX3244EAI+         | -40°C to +85°C | 28 SSOP     |
| <b>MAX3245</b> CWI+ | 0°C to +70°C   | 28 SO (W)   |
| MAX3245CAI+         | 0°C to +70°C   | 28 SSOP     |
| MAX3245EWI+         | -40°C to +85°C | 28 SO (W)   |
| MAX3245EAI+         | -40°C to +85°C | 28 SSOP     |

+Denotes a lead(Pb)-free/RoHS-compliant package.

\*EP = Exposed pad.

/V denotes an automotive qualified part.

## Chip Information

PROCESS: BiCMOS

## Package Information

For the latest package outline information and land patterns (footprints), go to [www.maxim-ic.com/packages](http://www.maxim-ic.com/packages). Note that a "+", "#", or "-" in the package code indicates RoHS status only. Package drawings may show a different suffix character, but the drawing pertains to the package regardless of RoHS status.

| PACKAGE TYPE | PACKAGE CODE | OUTLINE NO.             | LAND PATTERN NO.        |
|--------------|--------------|-------------------------|-------------------------|
| 16 SSOP      | A16+2        | <a href="#">21-0056</a> | <a href="#">90-0106</a> |
| 20 SSOP      | A20+2        | <a href="#">21-0056</a> | <a href="#">90-0094</a> |
| 20 TQFN-EP   | T2055+5      | <a href="#">21-0140</a> | <a href="#">90-0010</a> |
| 20 TSSOP     | U20+2        | <a href="#">21-0066</a> | <a href="#">90-0116</a> |
| 20 PDIP      | P20+3        | <a href="#">21-0043</a> | —                       |
| 28 SO (W)    | W28+6        | <a href="#">21-0042</a> | <a href="#">90-0109</a> |
| 28 SSOP      | A28+1        | <a href="#">21-0056</a> | <a href="#">90-0095</a> |

# 1 $\mu$ A Supply Current, 1Mbps, 3.0V to 5.5V, RS-232 Transceivers with AutoShutdown Plus

## Revision History

| REVISION NUMBER | REVISION DATE | DESCRIPTION   | PAGES CHANGED |
|-----------------|---------------|---|---------------|
| 3               | 5/05          | Added new packaging types   | —             |
| 4               | 10/08         | Added automotive qualified product information                        | 1, 18         |
| 5               | 2/11          | Changed all the parts in the <i>Ordering Information</i> to lead-free | 1, 18         |

MAX3224-MAX3227/MAX3244/MAX3245

Maxim cannot assume responsibility for use of any circuitry other than circuitry entirely embodied in a Maxim product. No circuit patent licenses are implied. Maxim reserves the right to change the circuitry and specifications without notice at any time.

Maxim Integrated Products, 120 San Gabriel Drive, Sunnyvale, CA 94086 408-737-7600 \_\_\_\_\_ 19