



SYNCHRONOUS DRAM MODULE

MT9LSDT872, MT9LSDT1672

For the latest data sheet, please refer to the Micron Web site: www.micronsemi.com/datasheets/datasheet.html

FEATURES

- JEDEC-standard 168-pin, dual in-line memory module (DIMM)
- PC133- and PC100-compliant
- Registered inputs with one-clock delay
- Phase-lock loop (PLL) clock driver to reduce loading
- Utilizes 133 MHz and 125 MHz SDRAM components
- ECC-optimized pinout
- 64MB (8 Meg x 72) and 128MB (16 Meg x 72)
- Single +3.3V ±0.3V power supply
- Fully synchronous; all signals registered on positive edge of PLL clock
- Internal pipelined operation; column address can be changed every clock cycle
- Internal SDRAM banks for hiding row access/precharge
- Programmable burst lengths: 1, 2, 4, 8, or full page
- Auto Precharge and Auto Refresh Modes
- Self Refresh Mode
- 64ms, 4,096-cycle refresh
- LVTTTL-compatible inputs and outputs
- Serial Presence-Detect (SPD)

OPTIONS

- Package
168-pin DIMM (gold)
- Frequency/CAS Latency*
133 MHz/CL = 2
(7.5ns, 133 MHz SDRAMs)
133 MHz/CL = 3
(7.5ns, 133 MHz SDRAMs)
100 MHz/CL = 2
(8ns, 125 MHz SDRAM)

MARKING

G

-13E

-133

-10E

*Device latency only; extra clock cycle required due to input register.

KEY SDRAM COMPONENT TIMING PARAMETERS

MODULE MARKING	SPEED GRADE	CAS LATENCY	ACCESS TIME	SETUP TIME	HOLD TIME
-13E	-7E	2	5.4ns	1.5ns	0.8ns
-133	-75	3	5.4ns	1.5ns	0.8ns
-10E	-8E	2	6ns	2ns	1ns

PIN ASSIGNMENT (FRONT VIEW) 168-PIN DIMM

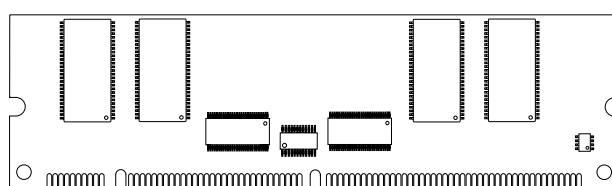

PIN	SYMBOL	PIN	SYMBOL	PIN	SYMBOL	PIN	SYMBOL
1	V _{SS}	43	V _{SS}	85	V _{SS}	127	V _{SS}
2	DQ0	44	DNU	86	DQ32	128	CKE0
3	DQ1	45	S2#	87	DQ33	129	RFU (S3#)
4	DQ2	46	DQMB2	88	DQ34	130	DQMB6
5	DQ3	47	DQMB3	89	DQ35	131	DQMB7
6	V _{DD}	48	DNU	90	V _{DD}	132	RFU (A13)
7	DQ4	49	V _{DD}	91	DQ36	133	V _{DD}
8	DQ5	50	NC	92	DQ37	134	NC
9	DQ6	51	NC	93	DQ38	135	NC
10	DQ7	52	CB2	94	DQ39	136	CB6
11	DQ8	53	CB3	95	DQ40	137	CB7
12	V _{SS}	54	V _{SS}	96	V _{SS}	138	V _{SS}
13	DQ9	55	DQ16	97	DQ41	139	DQ48
14	DQ10	56	DQ17	98	DQ42	140	DQ49
15	DQ11	57	DQ18	99	DQ43	141	DQ50
16	DQ12	58	DQ19	100	DQ44	142	DQ51
17	DQ13	59	V _{DD}	101	DQ45	143	V _{DD}
18	V _{DD}	60	DQ20	102	V _{DD}	144	DQ52
19	DQ14	61	NC	103	DQ46	145	NC
20	DQ15	62	NC	104	DQ47	146	NC
21	CB0	63	RFU (CKE1)	105	CB4	147	REGE
22	CB1	64	V _{SS}	106	CB5	148	V _{SS}
23	V _{SS}	65	DQ21	107	V _{SS}	149	DQ53
24	NC	66	DQ22	108	NC	150	DQ54
25	NC	67	DQ23	109	NC	151	DQ55
26	V _{DD}	68	V _{SS}	110	V _{DD}	152	V _{SS}
27	WE#	69	DQ24	111	CAS#	153	DQ56
28	DQMB0	70	DQ25	112	DQMB4	154	DQ57
29	DQMB1	71	DQ26	113	DQMB5	155	DQ58
30	S0#	72	DQ27	114	RFU (S1#)	156	DQ59
31	DNU	73	V _{DD}	115	RAS#	157	V _{DD}
32	V _{SS}	74	DQ28	116	V _{SS}	158	DQ60
33	A0	75	DQ29	117	A1	159	DQ61
34	A2	76	DQ30	118	A3	160	DQ62
35	A4	77	DQ31	119	A5	161	DQ63
36	A6	78	V _{SS}	120	A7	162	V _{SS}
37	A8	79	CK2	121	A9	163	CK3
38	A10	80	NC	122	BA0	164	NC
39	BA1	81	WP	123	A11	165	SA0
40	V _{DD}	82	SDA	124	V _{DD}	166	SA1
41	V _{DD}	83	SCL	125	CK1	167	SA2
42	CK0	84	V _{DD}	126	RFU (A12)	168	V _{DD}

NOTE: Symbols in parentheses are not used on these modules but may be used for other modules in this product family. They are for reference only.



PART NUMBERS

PART NUMBER	CONFIGURATION	SYSTEM BUS SPEED
MT9LSDT872G-13E__	8 Meg x 72	133 MHz
MT9LSDT872G-133__	8 Meg x 72	133 MHz
MT9LSDT872G-10E__	8 Meg x 72	100 MHz
MT9LSDT1672G-13E__	16 Meg x 72	133 MHz
MT9LSDT1672G-133__	16 Meg x 72	133 MHz
MT9LSDT1672G-10E__	16 Meg x 72	100 MHz

NOTE: All part numbers end with a two-place code (not shown), designating component and PCB revisions. Consult factory for current revision codes. Example: MT9LSDT1672G-133B1

GENERAL DESCRIPTION

The MT9LSDT872 and MT9LSDT1672 are high-speed CMOS, dynamic random-access, 64MB and 128MB memories organized in a x72 configuration. These modules use internally configured quad-bank SDRAMs with a synchronous interface (all signals are registered on the positive edge of clock signals CK0).

Read and write accesses to the SDRAM modules are burst oriented; accesses start at a selected location and continue for a programmed number of locations in a programmed sequence. Accesses begin with the registration of an ACTIVE command, which is then followed by a READ or WRITE command. The address bits registered coincident with the ACTIVE command are used to select the bank and row to be accessed (BA0, BA1 select the bank, A0-A11 select the row). The address bits registered coincident with the READ or WRITE command are used to select the starting column location for the burst access.

These modules provide for programmable READ or WRITE burst lengths of 1, 2, 4, or 8 locations, or full page, with a burst terminate option. An auto precharge function may be enabled to provide a self-timed row precharge that is initiated at the end of the burst sequence.

These modules use an internal pipelined architecture to achieve high-speed operation. This architecture is compatible with the $2n$ rule of prefetch architectures, but it also allows the column address to be changed on every

clock cycle to achieve a high-speed, fully random access. Precharging one bank while accessing one of the other three banks will hide the PRECHARGE cycles and provide seamless, high-speed, random-access operation.

These modules are designed to operate in 3.3V, low-power memory systems. An auto refresh mode is provided, along with a power-saving, power-down mode. All inputs and outputs are LVTTTL-compatible.

SDRAM modules offer substantial advances in DRAM operating performance, including the ability to synchronously burst data at a high data rate with automatic column-address generation, the ability to interleave between internal banks in order to hide precharge time, and the capability to randomly change column addresses on each clock cycle during a burst access. For more information regarding SDRAM operation, refer to the 64Mb and 128Mb SDRAM data sheets.

PLL AND REGISTER OPERATION

These modules can be operated in either registered mode (REGE pin HIGH), where the control/address input signals are latched in the register on one rising clock edge and sent to the SDRAM devices on the following rising clock edge (data access is delayed by one clock), or in buffered mode (REGE pin LOW) where the input signals pass through the register/buffer to the SDRAM devices on the same clock. A phase-lock loop (PLL) on the modules is used to redrive the clock signals to the SDRAM devices to minimize system clock loading (CK0 is connected to the PLL, and CK1, CK2 and CK3 are terminated).

SERIAL PRESENCE-DETECT OPERATION

These modules incorporate serial presence-detect (SPD). The SPD function is implemented using a 2,048-bit EEPROM. This nonvolatile storage device contains 256 bytes. The first 128 bytes can be programmed by Micron to identify the module type and various SDRAM organizations and timing parameters. The remaining 128 bytes of storage are available for use by the customer. System READ/WRITE operations between the master (system logic) and the slave EEPROM device (DIMM) occur via a standard IIC bus using the DIMM's SCL (clock) and SDA (data) signals, together with SA(2:0), which provide eight unique DIMM/EEPROM addresses.

SPD CLOCK AND DATA CONVENTIONS

Data states on the SDA line can change only during SCL LOW. SDA state changes during SCL HIGH are reserved for indicating start and stop conditions (Figures 1 and 2).

SPD START CONDITION

All commands are preceded by the start condition, which is a HIGH-to-LOW transition of SDA when SCL is HIGH. The SPD device continuously monitors the SDA and SCL lines for the start condition and will not respond to any command until this condition has been met.

SPD STOP CONDITION

All communications are terminated by a stop condition, which is a LOW-to-HIGH transition of SDA when SCL is HIGH. The stop condition is also used to place the SPD device into standby power mode.

SPD ACKNOWLEDGE

Acknowledge is a software convention used to indicate successful data transfers. The transmitting device, either master or slave, will release the bus after transmitting eight bits. During the ninth clock cycle, the receiver will pull the SDA line LOW to acknowledge that it received the eight bits of data (Figure 3).

The SPD device will always respond with an acknowledge after recognition of a start condition and its slave address. If both the device and a WRITE operation have been selected, the SPD device will respond with an acknowledge after the receipt of each subsequent eight-bit word. In the read mode the SPD device will transmit eight bits of data, release the SDA line and monitor the line for an acknowledge. If an acknowledge is detected and no stop condition is generated by the master, the slave will continue to transmit data. If an acknowledge is not detected, the slave will terminate further data transmissions and await the stop condition to return to standby power mode.

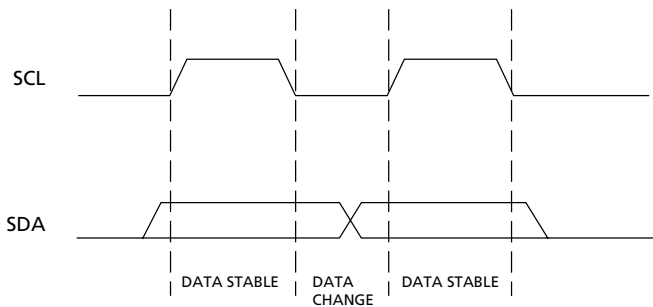

Figure 1
Data Validity

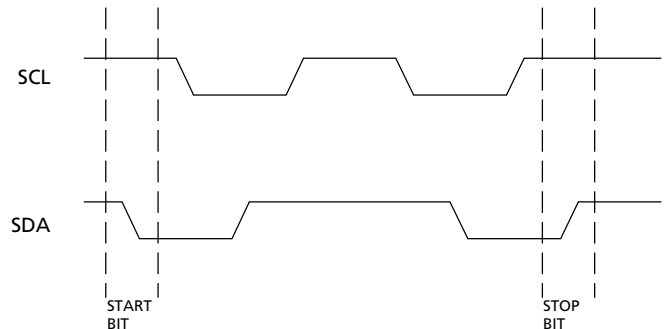

Figure 2
Definition of Start and Stop

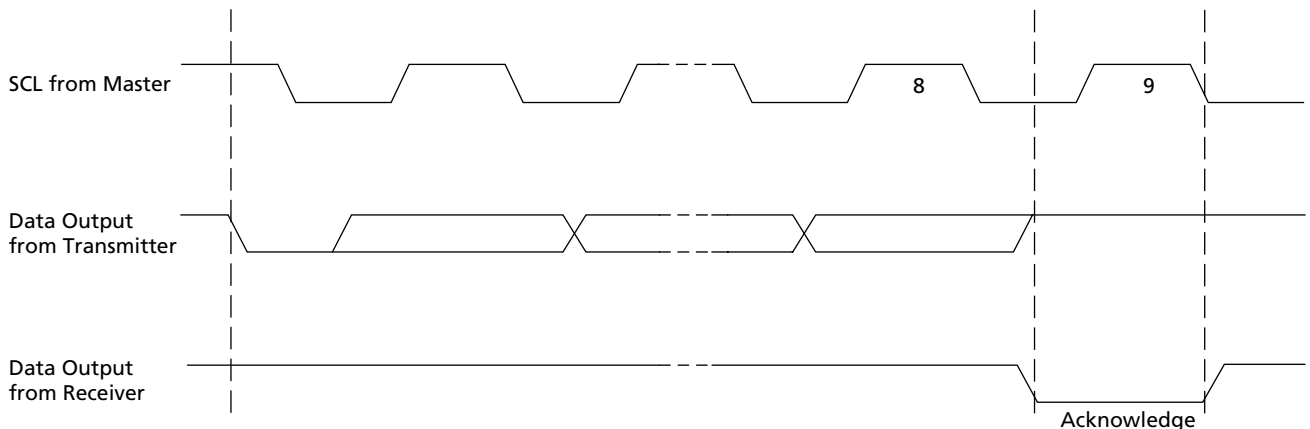
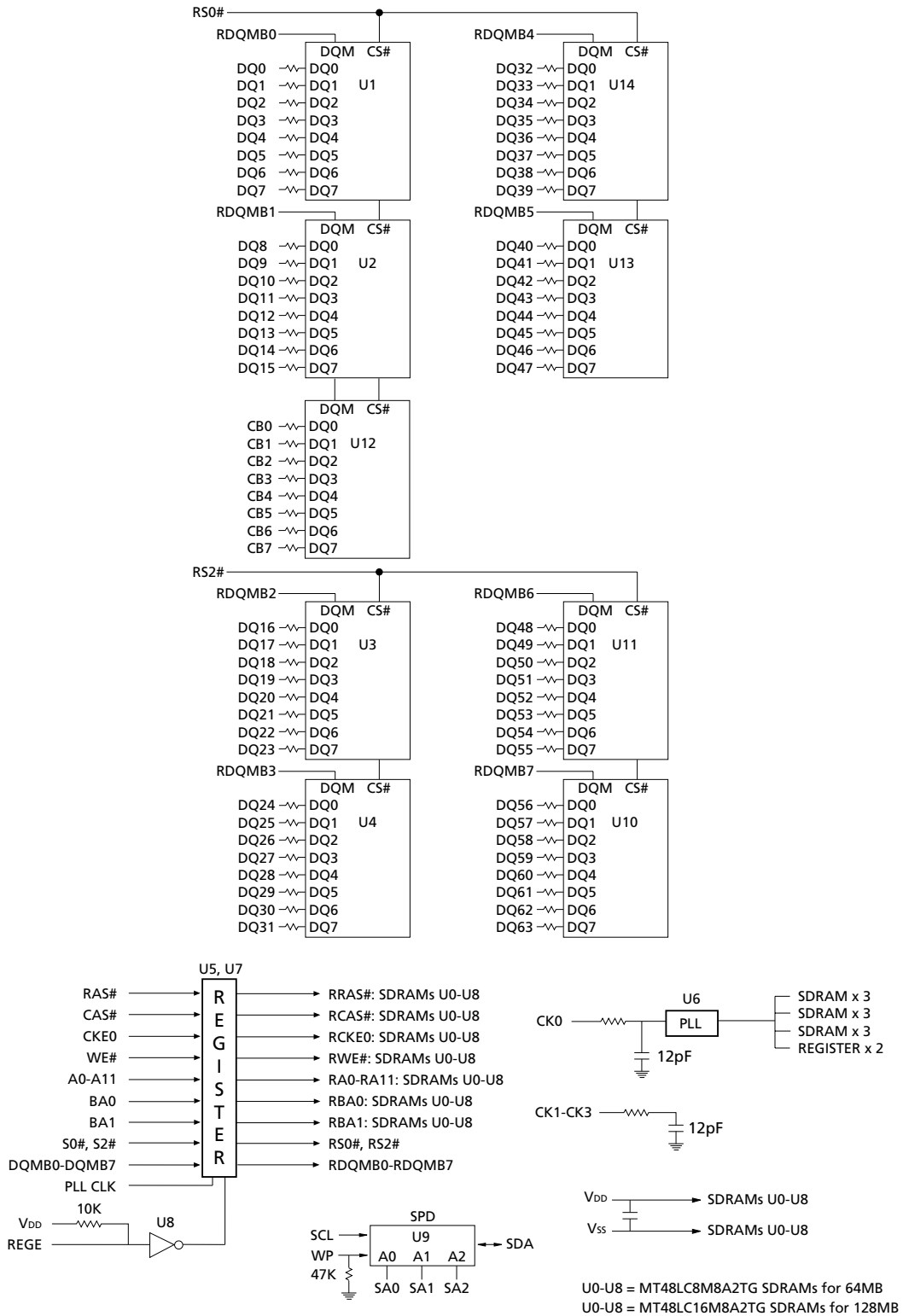

Figure 3
Acknowledge Response from Receiver



**FUNCTIONAL BLOCK DIAGRAM
MT9LSDT872 (64MB) AND MT9LSDT1672 (128MB)**



PIN DESCRIPTIONS

PIN NUMBERS	SYMBOL	TYPE	DESCRIPTION
27, 111, 115	WE#, CAS#, RAS#	Input	Command Inputs: WE#, RAS#, and CAS# (along with S0#, S2#) define the command being entered.
42, 79, 125, 163	CK0-CK3	Input	Clock: CK0 is distributed through an on-board PLL to all devices. CK1-CK3 are terminated.
128	CKE0	Input	Clock Enable: CKE0 activates (HIGH) and deactivates (LOW) the CK0 signal. Deactivating the clock provides POWER-DOWN and SELF REFRESH operation (all banks idle) or CLOCK SUSPEND operation (burst access in progress). CKE0 is synchronous except after the device enters power-down and self refresh modes, where CKE0 becomes asynchronous until after exiting the same mode. The input buffers, including CK0, are disabled during power-down and self refresh modes, providing low standby power.
30, 45	S0#, S2#	Input	Chip Select: S0#, S2# enable (registered LOW) and disable (registered HIGH) the command decoder. All commands are masked when S0#, S2# are registered HIGH. S0#, S2# are considered part of the command code.
28-29, 46-47, 112-113, 130-131	DQMB0-DQMB7	Input	Input/Output Mask: DQMB is an input mask signal for write accesses and an output enable signal for read accesses. Input data is masked when DQMB is sampled HIGH during a WRITE cycle. The output buffers are placed in a High-Z state (two-clock latency) when DQMB is sampled HIGH during a READ cycle.
122, 39	BA0, BA1	Input	Bank Address: BA0 and BA1 define to which bank the ACTIVE, READ, WRITE or PRECHARGE command is being applied.
33, 117, 34, 118, 35, 119, 36, 120, 37, 121, 38, 123	A0-A11	Input	Address Inputs: A0-A11 are sampled during the ACTIVE command (row-address A0-A11) and READ/WRITE command (column-address A0-A8/A9, with A10 defining auto precharge) to select one location out of the memory array in the respective bank. A10 is sampled during a PRECHARGE command to determine if both banks are to be precharged (A10 HIGH). The address inputs also provide the op-code during a LOAD MODE REGISTER command.
81	WP	Input	Write Protect: Serial presence-detect hardware write protect.
83	SCL	Input	Serial Clock for Presence-Detect: SCL is used to synchronize the presence-detect data transfer to and from the module.
165-167	SA0-SA2	Input	Presence-Detect Address Inputs: These pins are used to configure the presence-detect device.
147	REGE	Input	Register Enable.
2-5, 7-11, 13-17, 19-20, 55-58, 60, 65-67, 69-72, 74-77, 86-89, 91-95, 97-101, 103-104, 139-142, 144, 149-151, 153-156, 158-161	DQ0-DQ63	Input/Output	Data I/Os: Data bus.
21-22, 0 52-53, 105-106, 136-137	CB0-CB7	Input/Output	Check Bits.



PIN DESCRIPTIONS (continued)

PIN NUMBERS	SYMBOL	TYPE	DESCRIPTION
82	SDA	Input/ Output	Serial Presence-Detect Data: SDA is a bidirectional pin used to transfer addresses and data into and data out of the presence-detect portion of the module.
6, 18, 26, 40-41, 49, 59, 73, 84, 90, 102, 110, 124, 133, 143, 157, 168	V _{DD}	Supply	Power Supply: +3.3V ±0.3V.
1, 12, 23, 32, 43, 54, 64, 68, 78, 85, 96, 107, 116, 127, 138, 148, 152, 162	V _{SS}	Supply	Ground.
63, 114, 126, 129, 132	RFU	–	Reserved for Future Use: These pins are not connected on this module but are assigned pins on other SDRAM versions.
31, 44, 48	DNU	–	Do Not Use: These pins are not connected on this module but are assigned pins on the compatible DRAM version.



SERIAL PRESENCE-DETECT MATRIX

BYTE	DESCRIPTION	ENTRY (VERSION)	MT9LSDT872	MT9LSDT1672
0	NUMBER OF BYTES USED BY MICRON	128	80	80
1	TOTAL NUMBER OF SPD MEMORY BYTES	256	08	08
2	MEMORY TYPE	SDRAM	04	04
3	NUMBER OF ROW ADDRESSES	12	0C	0C
4	NUMBER OF COLUMN ADDRESSES	9 or 10	09	0A
5	NUMBER OF BANKS	1	01	01
6	MODULE DATA WIDTH	72	48	48
7	MODULE DATA WIDTH (continued)	0	00	00
8	MODULE VOLTAGE INTERFACE LEVELS	LVTTL	01	01
9	SDRAM CYCLE TIME, t_{CK} (CAS LATENCY = 3)	7 (-13E) 7.5 (-133) 8 (-10E)	70 75 80	70 75 80
10	SDRAM ACCESS FROM CLOCK, t_{AC} (CAS LATENCY = 3)	5.4 (-13E/-133) 6 (-10E)	54 60	54 60
11	MODULE CONFIGURATION TYPE	ECC	02	02
12	REFRESH RATE/TYPE	15.6 μ s/SELF	80	80
13	SDRAM WIDTH (PRIMARY SDRAM)	8	08	08
14	ERROR-CHECKING SDRAM DATA WIDTH	8	08	08
15	MIN. CLOCK DELAY FROM BACK-TO-BACK RANDOM COLUMN ADDRESSES, t_{CCD}	1	01	01
16	BURST LENGTHS SUPPORTED	1, 2, 4, 8, PAGE	8F	8F
17	NUMBER OF BANKS ON SDRAM DEVICE	4	04	04
18	CAS LATENCIES SUPPORTED	2, 3	06	06
19	CS LATENCY	0	01	01
20	WE LATENCY	0	01	01
21	SDRAM MODULE ATTRIBUTES	-13E/-133 -10E	1F 16	1F 16
22	SDRAM DEVICE ATTRIBUTES: GENERAL	0E	0E	0E
23	SDRAM CYCLE TIME, t_{CK} (CAS LATENCY = 2)	7.5 (-13E) 10 (-133/-10E)	75 A0	75 A0
24	SDRAM ACCESS FROM CLK, t_{AC} (CAS LATENCY = 2)	5.4(-13E) 6 (-10E)	54 60	54 60
25	SDRAM CYCLE TIME, t_{CK} (CAS LATENCY = 1)	-	00	00
26	SDRAM ACCESS FROM CLK, t_{AC} (CAS LATENCY = 1)	-	00	00
27	MINIMUM ROW PRECHARGE TIME, t_{RP}	15 (-13E) 20 (-133/-10E) 14 (-13E)	0F 14 0E	0F 14 0E
28	MINIMUM ROW ACTIVE TO ROW ACTIVE, t_{RRD}	14 (-13E) 15 (-133) 20 (-10E)	0E 0F 14	0E 0F 14
29	MINIMUM RAS# TO CAS# DELAY, t_{RCD}	15 (-13E) 20 (-133/-10E) 37 (-13E)	0F 14 25	0F 14 25

NOTE: 1. "1"/"0": Serial Data, "driven to HIGH"/"driven to LOW."



SERIAL PRESENCE-DETECT MATRIX (continued)

BYTE	DESCRIPTION	ENTRY (VERSION)	MT9LSDT872	MT9LSDT1672
30	MINIMUM RAS# PULSE WIDTH, ($t_{RAS\ MODULE} = t_{RC} - t_{RP}$)	45 (-13E)	2D	2D
		44 (-133)	2C	2C
		50 (-10E)	32	32
31	MODULE BANK DENSITY	64MB/128MB	10	20
32	COMMAND AND ADDRESS SETUP TIME, t_{AS} , t_{CMS}	1.5 (-13E/-133)	15	15
		2 (-10E)	20	20
33	COMMAND AND ADDRESS HOLD TIME, t_{AH} , t_{CMH}	0.8 (-13E/133)	08	08
		1 (-10E)	10	10
34	DATA SIGNAL INPUT SETUP TIME, t_{DS}	1.5 (-13E/-133)	15	15
		2 (-10E)	20	20
35	DATA SIGNAL INPUT HOLD TIME, t_{DH}	0.8 (-13E/-133)	08	08
		1 (-10E)	10	10
36-61	RESERVED		00	00
62	SPD REVISION	REV. 1.2	12	12
63	CHECKSUM FOR BYTES 0-62	-13E	88	99
		-133	C5	CE
		-10E	0D	16
64	MANUFACTURER'S JEDEC ID CODE	MICRON	2C	2C
65-71	MANUFACTURER'S JEDEC ID CODE (CONT.)		FF	FF
72	MANUFACTURING LOCATION		01	01
			02	02
			03	03
			04	04
			05	05
			06	06
			07	07
			08	08
			09	09
73-90	MODULE PART NUMBER (ASCII)		xx	xx
91	PCB IDENTIFICATION CODE	1	01	01
		2	02	02
		3	03	03
		4	04	04
		5	05	05
		6	06	06
		7	07	07
		8	08	08
		9	09	09
92	IDENTIFICATION CODE (CONT.)	0	00	00
93	YEAR OF MANUFACTURE IN BCD		xx	xx
94	WEEK OF MANUFACTURE IN BCD		xx	xx
95-98	MODULE SERIAL NUMBER		xx	xx
99-125	MANUFACTURER-SPECIFIC DATA (RSVD)		-	-
126	SYSTEM FREQUENCY	100/133 MHz	64	64
127	SDRAM COMPONENT AND CLOCK DETAIL		8F	8F

NOTE: 1. "1"/"0": Serial Data, "driven to HIGH"/"driven to LOW."
2. x = Variable Data.



Commands

Truth Table 1 provides a quick reference of available commands. This is followed by a written description of each command. For a more detailed description of

commands and operations refer to the 64Mb, 128Mb x4, x8, x16 SDRAM datasheets.

TRUTH TABLE 1 – COMMANDS AND DQMB OPERATION

(Note: 1)

NAME (FUNCTION)	CS#	RAS#	CAS#	WE#	DQMB	ADDR	DQs	NOTES
COMMAND INHIBIT (NOP)	H	X	X	X	X	X	X	
NO OPERATION (NOP)	L	H	H	H	X	X	X	
ACTIVE (Select bank and activate row)	L	L	H	H	X	Bank/Row	X	3
READ (Select bank and column, and start READ burst)	L	H	L	H	L/H ⁸	Bank/Col	X	4
WRITE (Select bank and column, and start WRITE burst)	L	H	L	L	L/H ⁸	Bank/Col	Valid	4
BURST TERMINATE	L	H	H	L	X	X	Active	
PRECHARGE (Deactivate row in bank or banks)	L	L	H	L	X	Code	X	5
AUTO REFRESH or SELF REFRESH (Enter self refresh mode)	L	L	L	H	X	X	X	6, 7
LOAD MODE REGISTER	L	L	L	L	X	Op-Code	X	2
Write Enable/Output Enable	–	–	–	–	L	–	Active	8
Write Inhibit/Output High-Z	–	–	–	–	H	–	High-Z	8

- NOTE:**
1. CKE is HIGH for all commands shown except SELF REFRESH.
 2. A0-A11 define the op-code written to the Mode Register.
 3. A0-A11 provide row address, and BA0, BA1 determine which bank is made active.
 4. A0-A8/A9 provide column address; A10 HIGH enables the auto precharge feature (nonpersistent), while A10 LOW disables the auto precharge feature; BA0, BA1 determine which bank is being read from or written to.
 5. A10 LOW: BA0, BA1 determine which bank is being precharged. A10 HIGH: both banks are precharged and BA0, BA1 are "Don't Care."
 6. This command is AUTO REFRESH if CKE is HIGH, SELF REFRESH if CKE is LOW.
 7. Internal refresh counter controls row addressing; all inputs and I/Os are "Don't Care" except for CKE.
 8. Activates or deactivates the DQs during WRITES (zero-clock delay) and READs (two-clock delay).

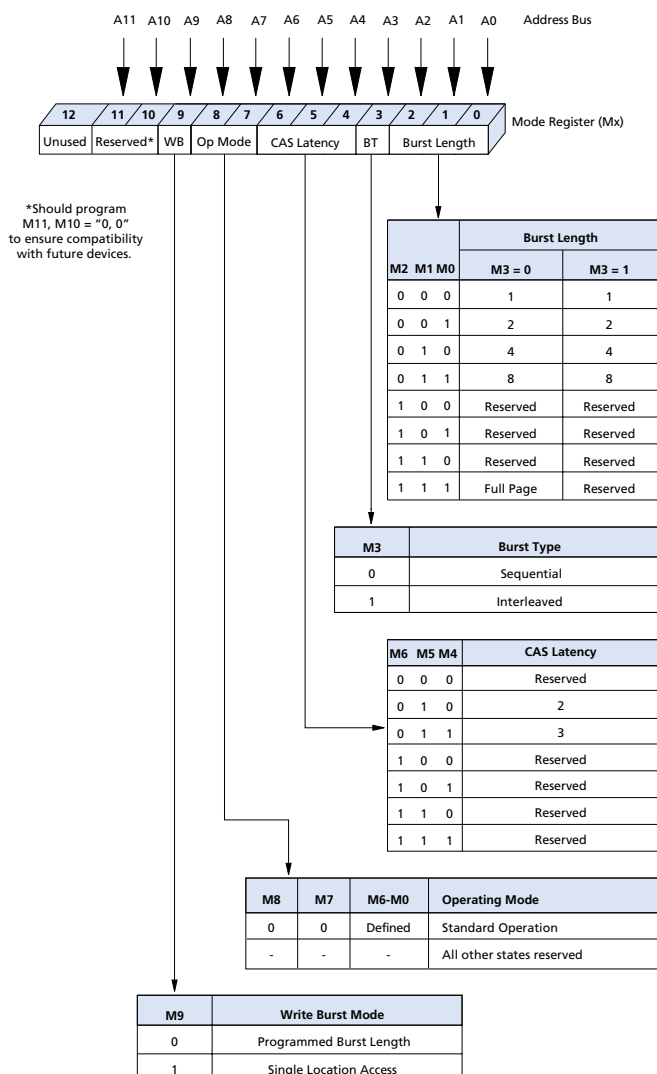

Figure 4 Mode Register Definition

Table 1 Burst Definition

Burst Length	Starting Column Address	Order of Accesses Within a Burst	
		Type = Sequential	Type = Interleaved
2	A0		
	0	0-1	0-1
	1	1-0	1-0
4	A1 A0		
	0 0	0-1-2-3	0-1-2-3
	0 1	1-2-3-0	1-0-3-2
	1 0	2-3-0-1	2-3-0-1
	1 1	3-0-1-2	3-2-1-0
	1 1	3-0-1-2	3-2-1-0
8	A2 A1 A0		
	0 0 0	0-1-2-3-4-5-6-7	0-1-2-3-4-5-6-7
	0 0 1	1-2-3-4-5-6-7-0	1-0-3-2-5-4-7-6
	0 1 0	2-3-4-5-6-7-0-1	2-3-0-1-6-7-4-5
	0 1 1	3-4-5-6-7-0-1-2	3-2-1-0-7-6-5-4
	1 0 0	4-5-6-7-0-1-2-3	4-5-6-7-0-1-2-3
	1 0 1	5-6-7-0-1-2-3-4	5-4-7-6-1-0-3-2
	1 1 0	6-7-0-1-2-3-4-5	6-7-4-5-2-3-0-1
1 1 1	7-0-1-2-3-4-5-6	7-6-5-4-3-2-1-0	
Full Page (y)	n = A0-9/8 (location 0-y)	Cn, Cn+1, Cn+2 Cn+3, Cn+4... ...Cn-1, Cn...	Not supported

- NOTE:**
- For full-page accesses: y = 1,024 (128MB), y = 512 (64MB)
 - For a burst length of two, A1-A9/A8 select the block of two burst; A0 selects the starting column within the block.
 - For a burst length of four, A2-A9/A8 select the block of four burst; A0-A1 select the starting column within the block.
 - For a burst length of eight, A3-A9/A8 select the block of eight burst; A0-A2 select the starting column within the block.
 - For a full-page burst, the full row is selected and A0-A9/A8 select the starting column.
 - Whenever a boundary of the block is reached within a given sequence above, the following access wraps within the block.
 - For a burst length of one, A0-A9/A8 select the unique column to be accessed, and Mode Register bit M3 is ignored.

**ABSOLUTE MAXIMUM RATINGS***

Voltage on V_{DD} Supply Relative to V_{SS} . -1V to +4.6V
Voltage on Inputs, NC or I/O Pins

Relative to V_{SS} -1V to +4.6V
Operating Temperature, T_A (ambient) ... 0°C to +70°C
Storage Temperature (plastic) -55°C to +125°C
Power Dissipation 18W

*Stresses greater than those listed under “Absolute Maximum Ratings” may cause permanent damage to the device. This is a stress rating only, and functional operation of the device at these or any other conditions above those indicated in the operational sections of this specification is not implied. Exposure to absolute maximum rating conditions for extended periods may affect reliability.

DC ELECTRICAL CHARACTERISTICS AND OPERATING CONDITIONS

(Notes: 1, 2) (V_{DD} = +3.3V ±0.3V)

PARAMETER/CONDITION	SYMBOL	MIN	MAX	UNITS	NOTES
SUPPLY VOLTAGE	V _{DD}	3	3.6	V	
INPUT HIGH VOLTAGE: Logic 1; All inputs	V _{IH}	2	V _{DD} + 0.3	V	3
INPUT LOW VOLTAGE: Logic 0; All inputs	V _{IL}	-0.5	0.8	V	3
INPUT LEAKAGE CURRENT: Any input 0V ≤ V _{IN} ≤ V _{DD} (All other pins not under test = 0V)	I _{I1}	-5	5	μA	4
OUTPUT LEAKAGE CURRENT: DQs are disabled; 0V ≤ V _{OUT} ≤ V _{DD}	I _{OZ}	-5	5	μA	
OUTPUT LEVELS: Output High Voltage (I _{OUT} = -4mA)	V _{OH}	2.4	-	V	
Output Low Voltage (I _{OUT} = 4mA)	V _{OL}	-	0.4	V	

- NOTE:**
- All voltages referenced to V_{SS}.
 - An initial pause of 100μs is required after power-up, followed by two AUTO REFRESH commands, before proper device operation is ensured. The two AUTO REFRESH command wake-ups should be repeated any time the t_{REF} refresh requirement is exceeded.
 - V_{IH} overshoot: V_{IH} (MAX) = V_{DD} + 2V for a pulse width ≤ 10ns, and the pulse width cannot be greater than one third of the cycle rate. V_{IL} undershoot: V_{IL} (MIN) = -2V for a pulse width ≤ 10ns, and the pulse width cannot be greater than one third of the cycle rate.
 - Input leakage values based on register electrical characteristics, V_{DD} = 3.6V.

**I_{DD} SPECIFICATIONS AND CONDITIONS**(Notes: 1-4) ($V_{DD} = +3.3V \pm 0.3V$)

PARAMETER/CONDITION	SYMBOL	SIZE	MAX			UNITS	NOTES	
			-13E	-133	-10E			
OPERATING CURRENT: Active Mode; Burst = 2; READ or WRITE; $t_{RC} = t_{RC}(\text{MIN})$; CAS latency = 3	I _{DD1}	64MB	1,125	1,035	855	mA	5, 6, 7, 8	
		128MB	1,440	1,350	1,260			
STANDBY CURRENT: Power-Down Mode; CKE = LOW; All banks idle	I _{DD2}	64MB	18	18	18	mA	8	
		128MB	18	18	18			
STANDBY CURRENT: Active Mode; S0#, S2# = HIGH; CKE = HIGH; All banks active after t_{RCD} met; No accesses in progress	I _{DD3}	64MB	405	405	315	mA	5, 7, 8, 9	
		128MB	450	450	360			
OPERATING CURRENT: Burst Mode; Continuous burst; READ or WRITE; All banks active; CAS latency = 3	I _{DD4}	64MB	1,350	1,260	1,080	mA	5, 6, 7, 8	
		128MB	1,485	1,350	1,260			
AUTO REFRESH CURRENT: CKE = HIGH; S0#, S2# = HIGH	I _{DD5}	$t_{RC} = t_{RC}(\text{MIN})$; CL = 3	64MB	2,070	1,890	1,710	mA	5, 6, 7, 8, 9
			128MB	2,970	2,790	2,430		
	$t_{RC} = 15.625\mu\text{s}$; CL = 3	I _{DD6}	64MB	27	27	27	mA	
			128MB	27	27	27		
SELF REFRESH CURRENT: CKE $\leq 0.2V$	I _{DD7}	64MB	9	9	9	mA	10	
		128MB	18	18	18			

- NOTE:**
- All voltages referenced to V_{SS} .
 - An initial pause of 100 μs is required after power-up, followed by two AUTO REFRESH commands, before proper device operation is ensured. The two AUTO REFRESH command wake-ups should be repeated any time the t_{REF} refresh requirement is exceeded.
 - AC timing and I_{DD} test have $V_{IL} = 0V$ and $V_{IH} = 3V$, with timing referenced to 1.5V crossover point. If the input transition time is longer than 1ns, then the timing is referenced at $V_{IL}(\text{MAX})$ and $V_{IL}(\text{MIN})$ and no longer at the 1.5V crossover point.
 - I_{DD} specifications are tested after the device is properly initialized.
 - I_{DD} is dependent on output loading and cycle rates. Specified values are obtained with minimum cycle time and the outputs open.
 - The I_{DD} current will decrease as the CAS latency is reduced. This is due to the fact that the maximum cycle rate is slower as the CAS latency is reduced.
 - Address transitions average one transition every two clocks.
 - $t_{CK} = 7\text{ns}$ for -13E; $t_{CK} = 7.5\text{ns}$ for -133; $t_{CK} = 10\text{ns}$ for -10E.
 - Other input signals are allowed to transition no more than once every two clocks and are otherwise at valid V_{IH} or V_{IL} levels.
 - Enables on-chip refresh and address counters.



CAPACITANCE

PARAMETER	SYMBOL	MAX	UNITS
Input Capacitance: A0-A11, BA0, BA1, RAS#, CAS#, WE#	C _{I1}	8	pF
Input Capacitance: S0#, S2#, CKE0, DQMB0#-DQMB7#	C _{I2}	8	pF
Input Capacitance: CK0	C _{I3}	6	pF
Input Capacitance: REGE	C _{I4}	5	pF
Input Capacitance: SCL, SA0-SA2, WP	C _{I5}	12	pF
Input/Output Capacitance: DQ0-DQ63, CB0-CB7, SDA	C _{I0}	8	pF

NOTE: This parameter is sampled. V_{DD} = +3.3V; f = 1 MHz.

SDRAM COMPONENT* AC ELECTRICAL CHARACTERISTICS

(Notes: 2, 3, 4, 5, 6, 7)

AC CHARACTERISTICS		SYMBOL	-13E		-133		-10E		UNITS	NOTES	
PARAMETER			MIN	MAX	MIN	MAX	MIN	MAX			
Access time from CLK (positive edge)	CL = 3	t _{AC}		5.4		5.4		6	ns	8	
	CL = 2	t _{AC}		5.4		6		6	ns		
Address hold time		t _{AH}	0.8		0.8		1		ns		
Address setup time		t _{AS}	1.5		1.5		2		ns		
CLK high level width		t _{CH}	2.5		2.5		3		ns		
CLK low level width		t _{CL}	2.5		2.5		3		ns		
Clock cycle time	CL = 3	t _{CK}	7		7.5		8		ns	9	
	CL = 2	t _{CK}	7.5		10		10		ns	9	
CKE hold time		t _{CKH}	0.8		0.8		1		ns		
CKE setup time		t _{CKS}	1.5		1.5		2		ns		
CS#, RAS#, CAS#, WE#, DQM hold time		t _{CMH}	0.8		0.8		1		ns		
CS#, RAS#, CAS#, WE#, DQM setup time		t _{CMS}	1.5		1.5		2		ns		
Data-in hold time		t _{DH}	0.8		0.8		1		ns		
Data-in setup time		t _{DS}	1.5		1.5		2		ns		
Data-out high-impedance time	CL = 3	t _{HZ}		5.4		5.4		6	ns	10	
	CL = 2	t _{HZ}		5.4		6		7	ns	10	
Data-out low-impedance time		t _{LZ}	1		1		1		ns		
Data-out hold time (load)		t _{OH}	2.7		2.7		3		ns		
Data-out hold time (no load)		t _{OH_N}	1.8		1.8		1.8		ns	11	
ACTIVE to PRECHARGE command		t _{RAS}	37	120,000	44	120,000	50	120,000	ns		
ACTIVE to ACTIVE command period		t _{RC}	60		66		70		ns		
ACTIVE to READ or WRITE delay		t _{RCD}	15		20		20		ns		
Refresh period (4,096 cycles)		t _{REF}		64		64		64	ms		
AUTO REFRESH PERIOD		t _{RFC}	66		66		70		ns		
PRECHARGE command period		t _{RP}	15		20		20		ns		
ACTIVE bank A to ACTIVE bank B command		t _{RRD}	14		15		20		ns		
Transition time		t _T	0.3	1.2	0.3	1.2	0.3	1.2	ns	12	
WRITE recovery time		t _{WR}	1 CLK + 7ns		1 CLK + 7.5ns		1 CLK + 7ns				13
			14		15		15		ns	14	
Exit SELF REFRESH to ACTIVE command		t _{XSR}	67		75		80		ns		

*Specifications for the SDRAM components used on the module.



- NOTE:**
1. This parameter is sampled. $V_{DD} = +3.3V$; $f = 1$ MHz.
 5. The minimum specifications are used only to indicate cycle time at which proper operation over the full temperature range ($0^{\circ}C \leq T_A \leq +70^{\circ}C$) is ensured.
 6. An initial pause of $100\mu s$ is required after power-up, followed by two AUTO REFRESH commands, before proper device operation is ensured. The two AUTO REFRESH command wake-ups should be repeated any time the t_{REF} refresh requirement is exceeded.
 7. AC characteristics assume $t_T = 1$ ns.
 8. In addition to meeting the transition rate specification, the clock and CKE must transit between V_{IH} and V_{IL} (or between V_{IL} and V_{IH}) in a monotonic manner.
 9. Outputs measured at 1.5V with equivalent load:

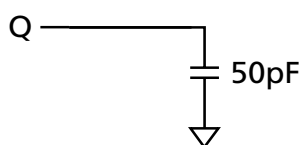

10. t_{HZ} defines the time at which the output achieves the open circuit condition; it is not a reference to V_{OH} or V_{OL} . The last valid data element will meet t_{OH} before going High-Z.
11. AC timing and I_{DD} test have $V_{IL} = 0V$ and $V_{IH} = 3V$, with timing referenced to 1.5V crossover point. If the input transition time is longer than 1ns, then the timing is referenced at V_{IL} (MAX) and V_{IL} (MIN) and no longer at the 1.5V crossover point.
24. There will be an added one-clock latency at the system level due to the register requiring an added clock cycle.
26. Auto precharge mode only. The precharge timing budget (t_{RP}) begins 7.5ns/7ns after the first clock delay, after the last WRITE is executed.
27. Precharge mode only.
28. The clock frequency must remain constant (stable clock is defined as a signal cycling within timing constraints specified for the clock pin) during access or precharge states (READ, WRITE, including t_{WR} , and PRECHARGE commands). CKE may be used to reduce the data rate.
30. t_{AC} for -133 at $CL = 3$ with no load is 4.6ns and is guaranteed by design.
32. Parameter guaranteed by design.



AC FUNCTIONAL CHARACTERISTICS

(Notes: 1-7)

PARAMETER	SYMBOL	-133	-13E/-10E	UNITS	NOTES	
READ/WRITE command to READ/WRITE command	t_{CCD}	1	1	t_{CK}	8	
CKE to clock disable or power-down entry mode	t_{CKED}	1	1	t_{CK}	9	
CKE to clock enable or power-down exit setup mode	t_{PED}	1	1	t_{CK}	9	
DQM to input data delay	t_{DQD}	0	0	t_{CK}	8	
DQM to data mask during WRITES	t_{DQM}	0	0	t_{CK}	8	
DQM to data high-impedance during READs	t_{DQZ}	2	2	t_{CK}	8	
WRITE command to input data delay	t_{DWD}	0	0	t_{CK}	8	
Data-in to ACTIVE command	t_{DAL}	5	4	t_{CK}	10, 11	
Data-in to PRECHARGE command	t_{DPL}	2	2	t_{CK}	11, 12	
Last data-in to burst STOP command	t_{BDL}	1	1	t_{CK}	8	
Last data-in to new READ/WRITE command	t_{CDL}	1	1	t_{CK}	8	
Last data-in to PRECHARGE command	t_{RDL}	2	2	t_{CK}	11, 12	
LOAD MODE REGISTER command to ACTIVE or REFRESH command	t_{MRD}	2	2	t_{CK}	13	
Data-out to high-impedance from PRECHARGE command	CL = 3	t_{ROH}	3	3	t_{CK}	8
	CL = 2	t_{ROH}	2	2	t_{CK}	8

- NOTE:**
- The minimum specifications are used only to indicate cycle time at which proper operation over the full temperature range ($0^{\circ}\text{C} \leq T_A \leq +70^{\circ}\text{C}$) is ensured.
 - An initial pause of 100 μs is required after power-up, followed by two AUTO REFRESH commands, before proper device operation is ensured. The two AUTO REFRESH command wake-ups should be repeated any time the t_{REF} refresh requirement is exceeded.
 - AC characteristics assume $t_T = 1\text{ns}$.
 - In addition to meeting the transition rate specification, the clock and CKE must transit between V_{IH} and V_{IL} (or between V_{IL} and V_{IH}) in a monotonic manner.
 - Outputs measured at 1.5V with equivalent load:

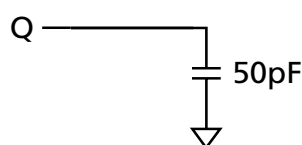

- AC timing and I_{DD} test have $V_{IL} = 0\text{V}$ and $V_{IH} = 3\text{V}$, with timing referenced to 1.5V crossover point. If the input transition time is longer than 1ns, then the timing is referenced at V_{IL} (MAX) and V_{IL} (MIN) and no longer at the 1.5V crossover point.
- There will be an added one-clock latency at the system level due to the register requiring an added clock cycle.
- Required clocks are specified by JEDEC functionality and are not dependent on any timing parameter.
- Timing actually specified by t_{CKS} ; clock(s) specified as a reference only at minimum cycle rate.
- Timing actually specified by t_{WR} plus t_{RP} ; clock(s) specified as a reference only at minimum cycle rate.
- Based on $t_{CK} = 143\text{MHz}$ for -13E, $t_{CK} = 133\text{MHz}$ for -133, 100 MHz for -10E.
- Timing actually specified by t_{WR} .
- JEDEC and PC100 specify three clocks.

**SERIAL PRESENCE-DETECT EEPROM DC OPERATING CONDITIONS**(Note: 1) ($V_{DD} = +3.3V \pm 0.3V$)

PARAMETER/CONDITION	SYMBOL	MIN	MAX	UNITS
SUPPLY VOLTAGE	V_{DD}	3	3.6	V
INPUT HIGH VOLTAGE: Logic 1; All inputs	V_{IH}	$V_{DD} \times 0.7$	$V_{DD} + 0.5$	V
INPUT LOW VOLTAGE: Logic 0; All inputs	V_{IL}	-1	$V_{DD} \times 0.3$	V
OUTPUT LOW VOLTAGE: $I_{OUT} = 3mA$	V_{OL}	-	0.4	V
INPUT LEAKAGE CURRENT: $V_{IN} = GND$ to V_{DD}	I_{LI}	-	10	μA
OUTPUT LEAKAGE CURRENT: $V_{OUT} = GND$ to V_{DD}	I_{LO}	-	10	μA
STANDBY CURRENT: SCL = SDA = $V_{DD} - 0.3V$; All other inputs = GND or $3.3V + 10\%$	I_{SB}	-	30	μA
POWER SUPPLY CURRENT: SCL clock frequency = 100 KHz	I_{DD}	-	2	mA

SERIAL PRESENCE-DETECT EEPROM AC OPERATING CONDITIONS(Note: 1) ($V_{DD} = +3.3V \pm 0.3V$)

PARAMETER/CONDITION	SYMBOL	MIN	MAX	UNITS	NOTES
SCL LOW to SDA data-out valid	t_{AA}	0.3	3.5	μs	
Time the bus must be free before a new transition can start	t_{BUF}	4.7		μs	
Data-out hold time	t_{DH}	300		ns	
SDA and SCL fall time	t_F		300	ns	
Data-in hold time	$t_{HD:DAT}$	0		μs	
Start condition hold time	$t_{HD:STA}$	4		μs	
Clock HIGH period	t_{HIGH}	4		μs	
Noise suppression time constant at SCL, SDA inputs	t_I		100	ns	
Clock LOW period	t_{LOW}	4.7		μs	
SDA and SCL rise time	t_R		1	μs	
SCL clock frequency	f_{SCL}		100	KHz	
Data-in setup time	$t_{SU:DAT}$	250		ns	
Start condition setup time	$t_{SU:STA}$	4.7		μs	
Stop condition setup time	$t_{SU:STO}$	4.7		μs	
WRITE cycle time	t_{WRC}		10	ms	2

- NOTE:**
- All voltages referenced to V_{SS} .
 - The SPD EEPROM WRITE cycle time (t_{WRC}) is the time from a valid stop condition of a write sequence to the end of the EEPROM internal erase/program cycle. During the WRITE cycle, the EEPROM bus interface circuit is disabled, SDA remains HIGH due to pull-up resistor, and the EEPROM does not respond to its slave address.

SPD EEPROM

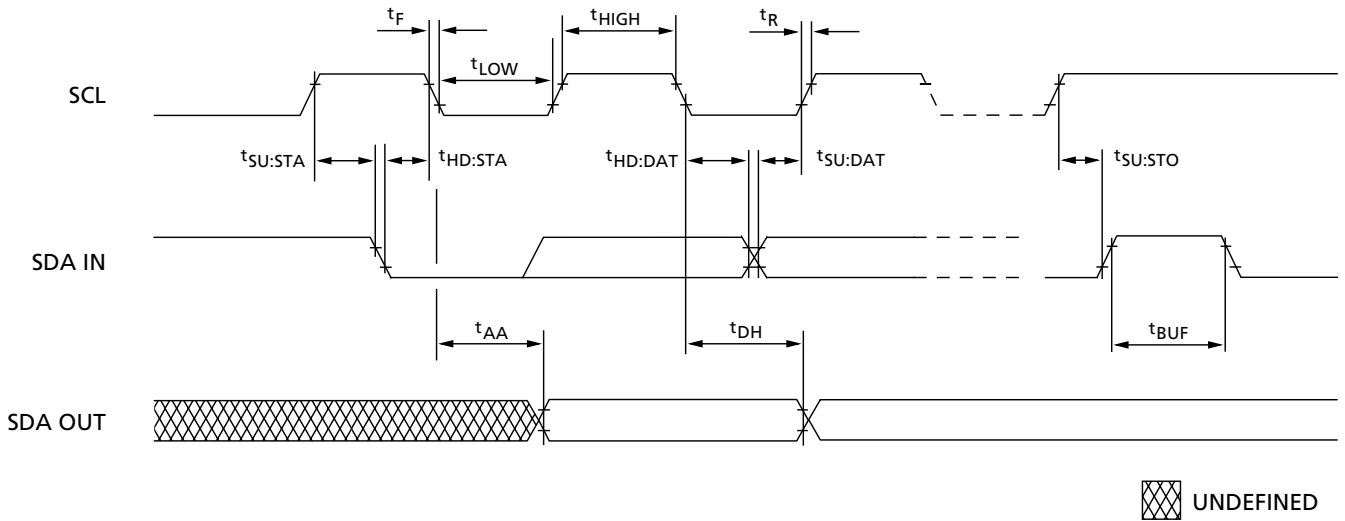

SERIAL PRESENCE-DETECT EEPROM TIMING PARAMETERS

SYMBOL	MIN	MAX	UNITS
t_{AA}	0.3	3.5	μs
t_{BUF}	4.7		μs
t_{DH}	300		ns
t_F		300	ns
$t_{HD:DAT}$	0		μs
$t_{HD:STA}$	4		μs

SYMBOL	MIN	MAX	UNITS
t_{HIGH}	4		μs
t_{LOW}	4.7		μs
t_R		1	μs
$t_{SU:DAT}$	250		ns
$t_{SU:STA}$	4.7		μs
$t_{SU:STO}$	4.7		μs

