

**UGN-3501K AND UGN-3501LI
DIFFERENTIAL DUAL OUTPUT HALL EFFECT SENSORS**

**UGN-3501K AND UGN-3501LI
LINEAR DIFFERENTIAL OUTPUT HALL EFFECT SENSORS**

FEATURES

- Excellent Sensitivity
- Flat Response to 25 kHz (Typ.)
- Internal Voltage Regulation
- Excellent Temperature Stability

UGN-3501K and UGN-3501LI are Hall Effect integrated circuits that provide linear differential output as a function of magnetic flux density at the sensor. They are principally used to sense relatively small changes in a magnetic field—changes too small to operate a Hall Effect switch. Applications include accurate measurement of electrical current with negligible system loading and fine control of mechanical attributes such as position, weight, thickness and velocity.

Each device includes a Hall cell, linear differential amplifier, differential emitter-follower output stage, and voltage regulator on a monolithic silicon chip. Both are rated for operation over a supply voltage range of 8.0 V to 16 V and over a temperature range of 0°C to +70°C. The pinout of UGN-3501LI includes provisions for output offset nulling with the addition of an external resistor.

UGN-3501K is supplied in a four-lead single in-line plastic package. UGN-3501LI is furnished in an eight-lead SO-8 surface-mount plastic package that conforms to JEDEC registration MS-102AA.

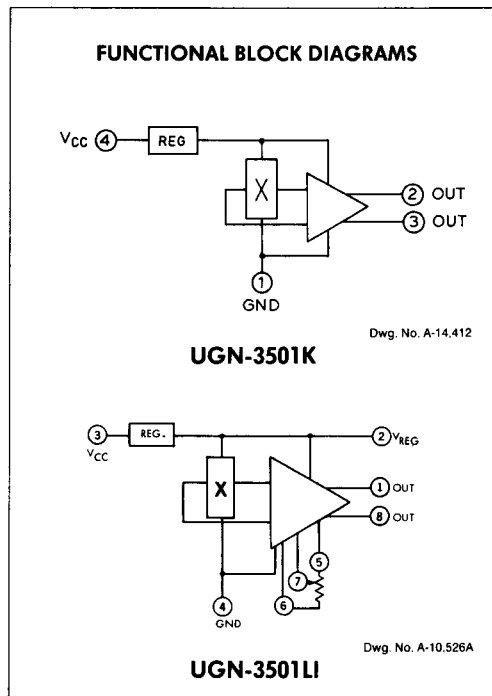

4

ABSOLUTE MAXIMUM RATINGS

Supply Voltage, V_{CC}	+ 16 V
Output Current, I_{OUT}	4 mA
Magnetic Flux Density, B	Unlimited
Operating Temperature Range, T_A	0°C to +70°C
Storage Temperature Range, T_S	-65°C to +150°C

UGN-3501K AND UGN-3501LI
DIFFERENTIAL DUAL OUTPUT HALL EFFECT SENSORS

ELECTRICAL CHARACTERISTICS at $T_A = +25^\circ\text{C}$, $V_{CC} = 12\text{ V}$ (unless otherwise noted)

Characteristic	Test Conditions	Limits			
		Min.	Typ.	Max.	Units
Operating Voltage		8.0	—	16	V
Supply Current	$V_{CC} = 16\text{ V}$	—	10	18	mA
Output Offset Voltage	UGN-3501K, B = 0G	—	100	400	mV
	UGN-3501LI, B = 0G, $R_{5-6-7} = 0\ \Omega$	—	100	400	mV
Output Common-Mode Voltage	B = 0G	—	3.6	—	V
Sensitivity	UGN-3501K, B = 1000 G	0.7	1.4	—	mV/G
	UGN-3501LI, B = 1000 G, $R_{5-6-7} = 0\ \Omega$	0.7	1.4	—	mV/G
	UGN-3501LI, B = 1000 G, $R_{5-6} = 15\ \Omega$	0.65	1.3	—	mV/G
Frequency Response (– 3 dB Down)	$R_{5-6-7} = 0\ \Omega$ (UGN-3501LI)	23	25	—	kHz
Broadband Output Noise	3 dB Bandwidth, 10 Hz to 10 kHz, $R_{5-6-7} = 0\ \Omega$ (UGN-3501LI)	—	0.15	—	mV
Offset Temperature Coefficient	$R_{5-6-7} = 0\ \Omega$ (UGN-3501LI)	—	1.0	—	mV/°C

NOTES:

- All output voltage measurements are made with a voltmeter having an input impedance of 10 k Ω or greater and a common-mode rejection ratio greater than 60 dB.
- Magnetic flux density is measured at the most sensitive area of the device. For the UGN-3501LI, that is at top center, 0.015" \pm 0.001" (0.38 mm \pm 0.03 mm) below the surface. For the UGN-3501K, it is 0.017" \pm 0.001" (0.43 mm \pm 0.03 mm) below the center of the branded surface.

**NORMALIZED SENSITIVITY
AS A FUNCTION OF V_{CC}**

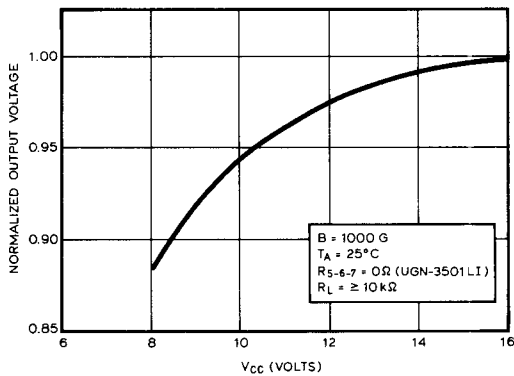

Dwg. No. A-10.529A

**NORMALIZED SENSITIVITY
AS A FUNCTION OF TEMPERATURE**

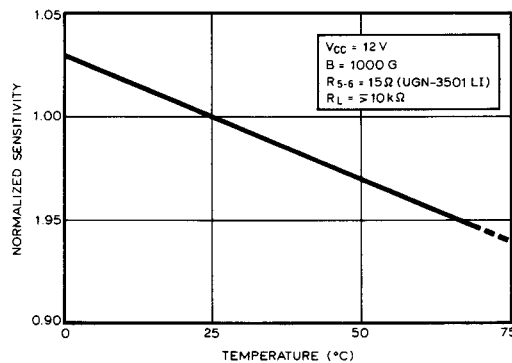

Dwg. No. A-10.530A

**UGN-3501K AND UGN-3501LI
DIFFERENTIAL DUAL OUTPUT HALL EFFECT SENSORS**

**RELATIVE OUTPUT VOLTAGE
AS A FUNCTION OF LOAD RESISTANCE**

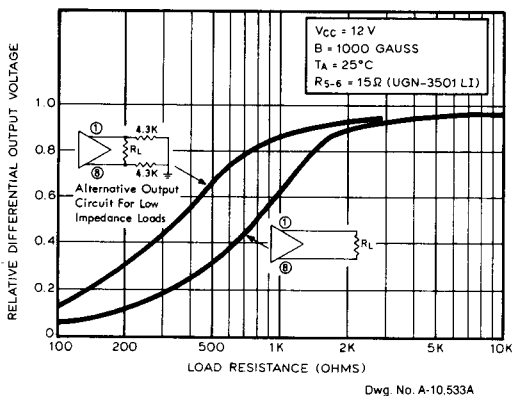

**OUTPUT VOLTAGE
AS A FUNCTION OF MAGNETIC FLUX DENSITY**

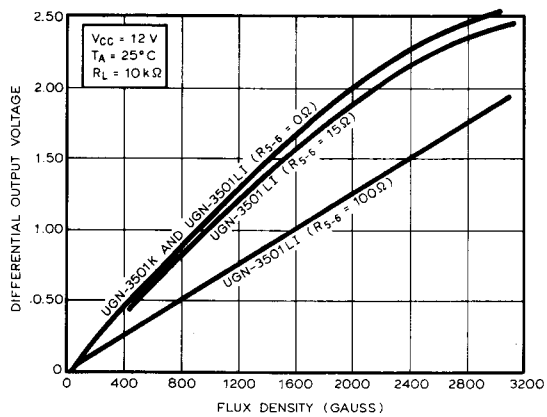

**OUTPUT VOLTAGE
AS A FUNCTION OF AIR GAP**

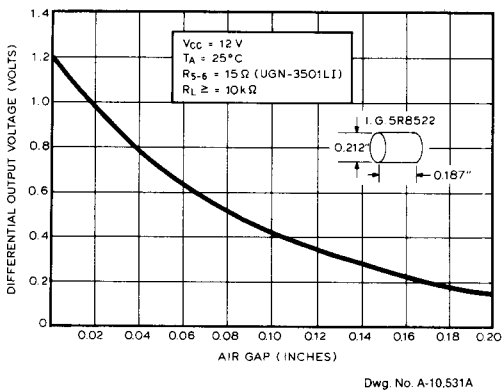

**NOISE SPECTRAL DENSITY
AS A FUNCTION OF FREQUENCY**

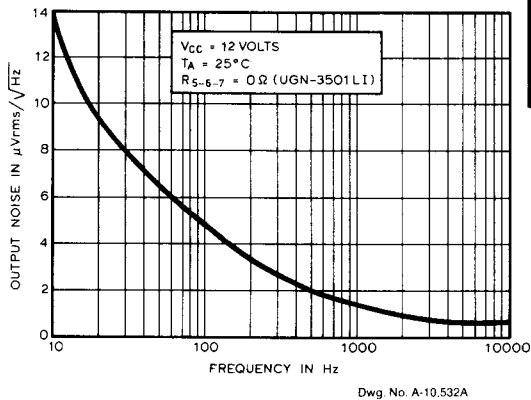

4

GUIDE TO INSTALLATION

1. All Hall Effect integrated circuits are susceptible to mechanical stress effects. Caution should be exercised to minimize the application of stress to the leads or the epoxy package.
2. To prevent permanent damage to the Hall cell IC, heat sink the leads during hand soldering. For wave soldering, the part should not experience more than 230°C for more than 5 seconds and no closer than 0.125" to the epoxy package.
3. If a zeroing potentiometer is used with UGN-3501LI, minimize lead lengths from it and isolate

these leads from output leads if possible. In some cases, it may be more practical to limit the frequency response with an output RC network to prevent oscillation:

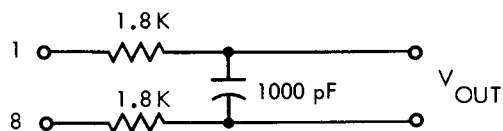

Dwg. No. A-10.536