

# Power MOSFET ISOPLUS220™

## Electrically Isolated Back Surface

Low  $R_{DS(on)}$ , High Voltage, CoolMOS™  
Superjunction MOSFET

Preliminary Data Sheet

## IXKC 25N80C

$$\begin{aligned} V_{DSS} &= 800 \text{ V} \\ I_{D25} &= 20 \text{ A} \\ R_{DS(on)} &= 150 \text{ m}\Omega \end{aligned}$$

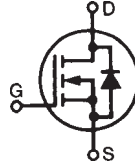

Symbol	Test Conditions	Maximum Ratings	
$V_{DSS}$	$T_J = 25^\circ\text{C}$ to $150^\circ\text{C}$	800	V
$V_{GS}$	Continuous	$\pm 20$	V
$V_{GSM}$	Transient	$\pm 30$	V
$I_{D25}$	$T_C = 25^\circ\text{C}$	20	A
$I_{D90}$	$T_C = 90^\circ\text{C}$	14	A
$I_{D(RMS)}$	Package lead current limit	45	A
$E_{AS}$	$I_o = 10\text{A}$ , $T_C = 25^\circ\text{C}$	690	mJ
$E_{AR}$	$I_o = 20\text{A}$	0.5	mJ
$dv/dt$	$V_{DS} < V_{DSS}$ , $I_F \leq 17\text{A}$ , $T_{VJ} = 150^\circ\text{C}$ $dI_{IR}/dt = 100\text{A}/\mu\text{s}$	6	V/ns
$P_D$	$T_C = 25^\circ\text{C}$	140	W
$T_J$		-55 ... +150	$^\circ\text{C}$
$T_{JM}$		150	$^\circ\text{C}$
$T_{stg}$		-55 ... +125	$^\circ\text{C}$
$T_L$	1.6 mm (0.062 in.) from case for 10 s	300	$^\circ\text{C}$
$V_{ISOL}$	RMS leads-to-tab, 50/60 Hz, $t = 1$ minute	2500	V~
$F_C$	Mounting force	11 ... 65 / 2.4 ... 11	N/lb
<b>Weight</b>		3	g

ISOPLUS220™  
E153432

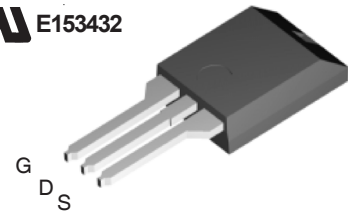

G = Gate, D = Drain,  
S = Source

### Features

- Silicon chip on Direct-Copper-Bond substrate
  - High power dissipation
  - Isolated mounting surface
  - 2500V electrical isolation
- 3<sup>RD</sup> generation CoolMos power MOSFET
  - High blocking capability
  - Low on resistance
  - Avalanche rated for unclamped inductive switching (UIS)
- Low thermal resistance due to reduced chip thickness
- Low drain to tab capacitance (<30pF)

### Applications

- Switched Mode Power Supplies (SMPS)
- Uninterruptible Power Supplies (UPS)
- Power Factor Correction (PFC)
- Welding
- Inductive Heating

### Advantages

- Easy assembly: no screws or isolation foils required
- Space savings
- High power density

CoolMos is a trademark of Infineon Technology.

Symbol	Test Conditions	Characteristic Values ( $T_J = 25^\circ\text{C}$ , unless otherwise specified)		
		min.	typ.	max.
$R_{DS(on)}$	$V_{GS} = 10\text{V}$ , $I_D = I_{D90}$ , Note 1 $V_{GS} = 10\text{V}$ , $I_D = I_{D90}$ , Note 1 $T_J = 125^\circ\text{C}$		136 280	150 m $\Omega$ m $\Omega$
$V_{GS(th)}$	$V_{DS} = V_{GS}$ , $I_D = 2\text{mA}$	2		4 V
$I_{DSS}$	$V_{DS} = V_{DSS}$ $V_{GS} = 0\text{V}$		10	50 $\mu\text{A}$ $\mu\text{A}$
$I_{GSS}$	$V_{GS} = \pm 20\text{V}_{DC}$ , $V_{DS} = 0$			$\pm 200$ nA

IXYS

IXKC 25N80C

Symbol	Test Conditions	Characteristic Values ( $T_J = 25^\circ\text{C}$ , unless otherwise specified)		
		min.	typ.	max.
$g_{fs}$	$V_{DS} = 15\text{ V}; I_D = 0.5 \cdot I_{D90}$ , pulse test	14	20	S
$C_{iss}$	$V_{GS} = 0\text{ V}, V_{DS} = 25\text{ V}, f = 1\text{ MHz}$		4600	pF
$C_{oss}$		2500	pF	
$C_{rss}$		120	pF	
$Q_{g(on)}$	$V_{GS} = 10\text{ V}, V_{DS} = 640\text{ V}, I_D = I_{D90}$		180	nC
$Q_{gs}$		20	nC	
$Q_{gd}$		80	nC	
$t_{d(on)}$	$V_{GS} = 10\text{ V}, V_{DS} = 640\text{ V}$ $I_D = 35\text{ A}, R_G = 2.2\ \Omega$		25	ns
$t_r$		25	ns	
$t_{d(off)}$		75	ns	
$t_f$		10	ns	
$R_{thJC}$			0.9	K/W
$R_{thCH}$		0.30		K/W

## Reverse Conduction

Symbol	Test Conditions	Characteristic Values ( $T_J = 25^\circ\text{C}$ , unless otherwise specified)		
		min.	typ.	max.
$V_{SD}$	$I_F = 12.5\text{ A}, V_{GS} = 0\text{ V}$ Note 1		1	1.2 V

Note: 1. Pulse test,  $t \leq 300\ \mu\text{s}$ , duty cycle  $d \leq 2\%$ 

## ISOPLUS220 Outline

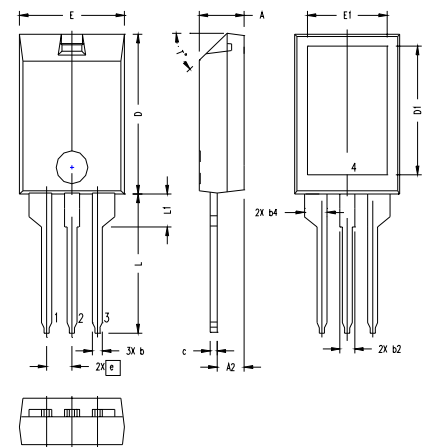

SYM	INCHES		MILLIMETERS	
	MIN	MAX	MIN	MAX
A	.157	.197	4.00	5.00
A2	.098	.118	2.50	3.00
b	.035	.051	0.90	1.30
b2	.049	.065	1.25	1.65
b4	.093	.100	2.35	2.55
c	.028	.039	0.70	1.00
D	.591	.630	15.00	16.00
D1	.472	.512	12.00	13.00
E	.394	.433	10.00	11.00
E1	.295	.335	7.50	8.50
e	.100 BASIC		2.55 BASIC	
L	.512	.571	13.00	14.50
L1	.118	.138	3.00	3.50
T*			42.5*	47.5*

## NOTE:

- Bottom heatsink (Pin 4) is electrically isolated from Pin 1, 2, or 3.
- This drawing will meet dimensional requirement of JEDEC SS Product Outline TO-273 except D and D1 dimension.

IXYS reserves the right to change limits, test conditions, and dimensions.

IXYS MOSFETs and IGBTs are covered by one or more 4,850,072 4,931,844 5,034,796 5,063,307 5,237,481 5,381,025 6,404,065B1 6,162,665 6,534,343 6,583,505 of the following U.S. patents: 4,835,592 4,881,106 5,017,508 5,049,961 5,187,117 5,486,715 6,306,728B1 6,259,123B1 6,306,728B1 6,683,344

**Fig. 1. Output Characteristics**  
@ 25°C

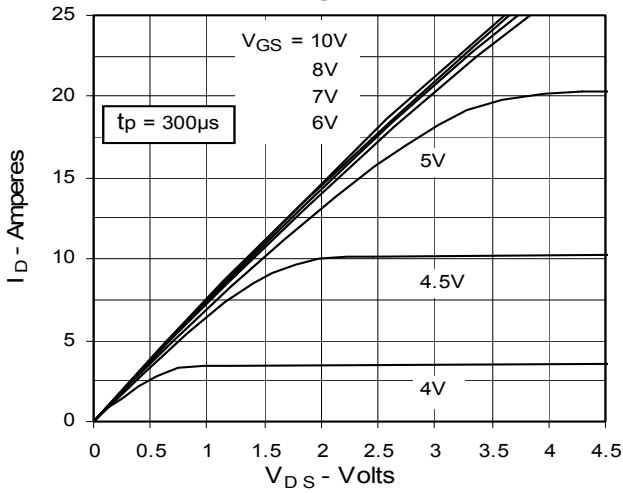

**Fig. 2. Extended Output Characteristics**  
@ 25°C

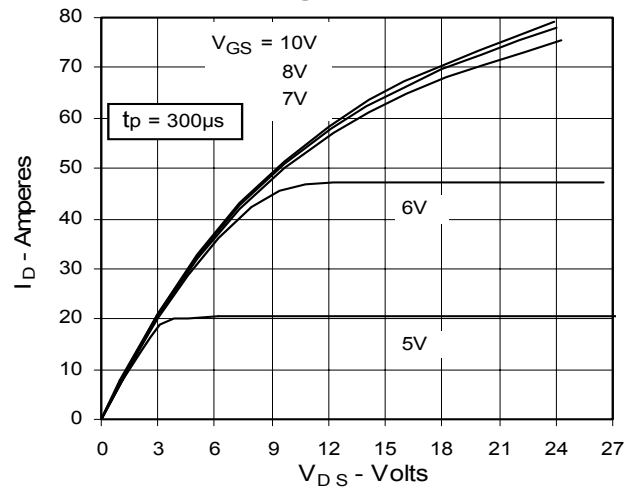

**Fig. 3. Output Characteristics**  
@ 125°C

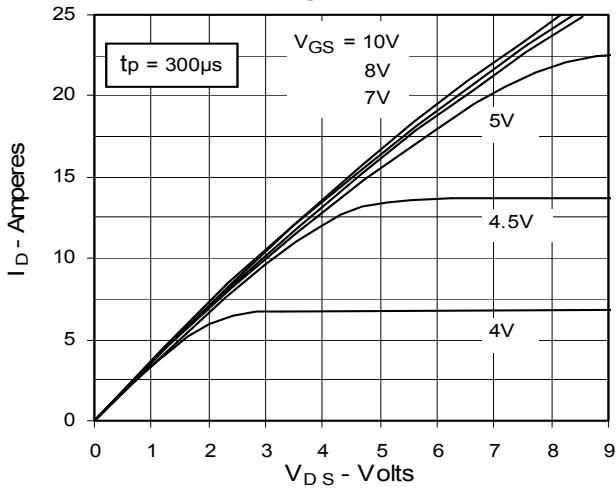

**Fig. 4.  $R_{DS(on)}$  Normalized to 0.5  $I_{D90}$  Value vs. Junction Temperature**

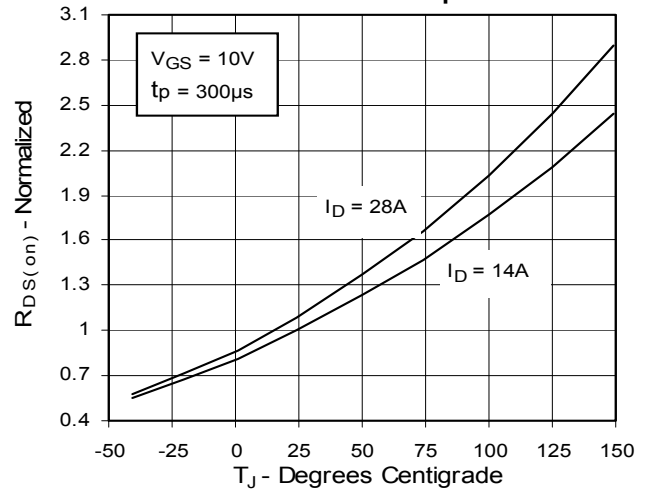

**Fig. 5.  $R_{DS(on)}$  Normalized to 0.5  $I_{D90}$  Value vs.  $I_D$**

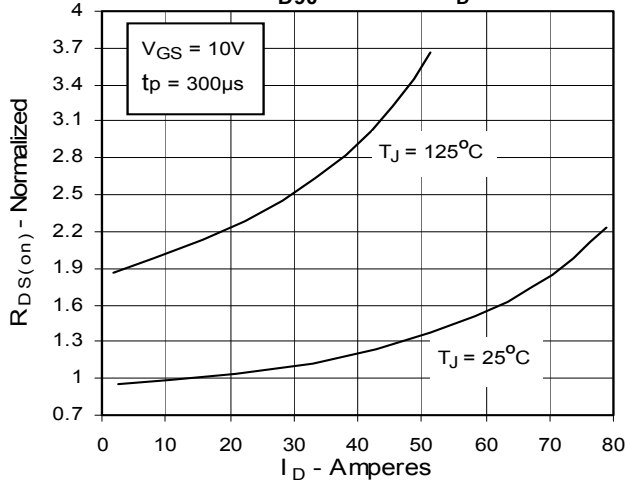

**Fig. 6. Drain Current vs. Case Temperature**

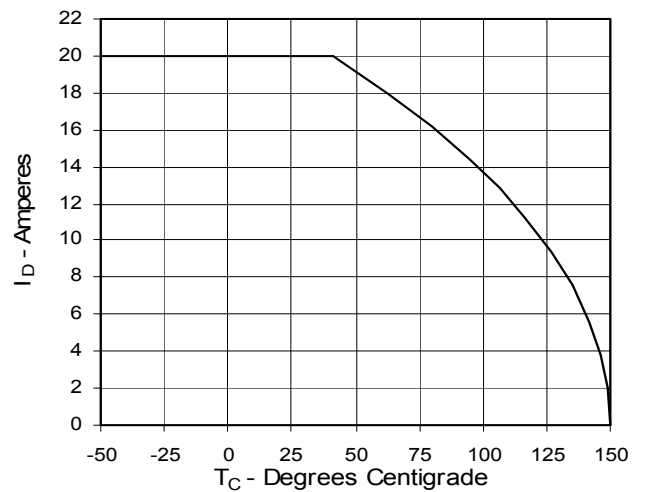

**Fig. 7. Input Admittance**

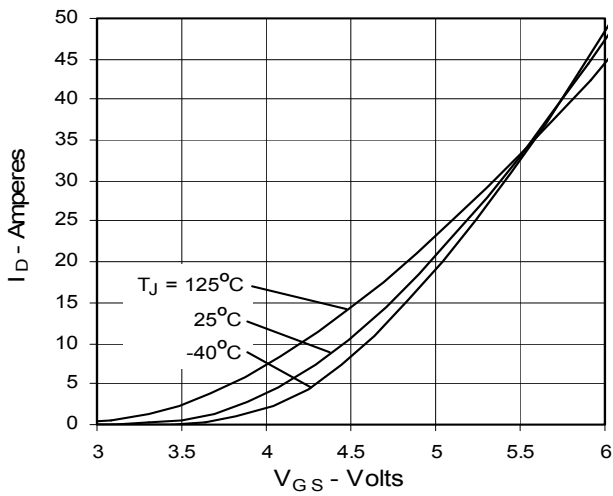

**Fig. 8. Transconductance**

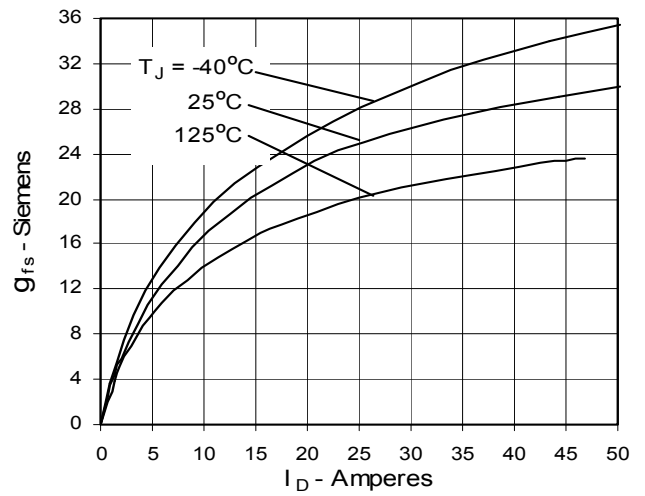

**Fig. 9. Source Current vs. Source-To-Drain Voltage**

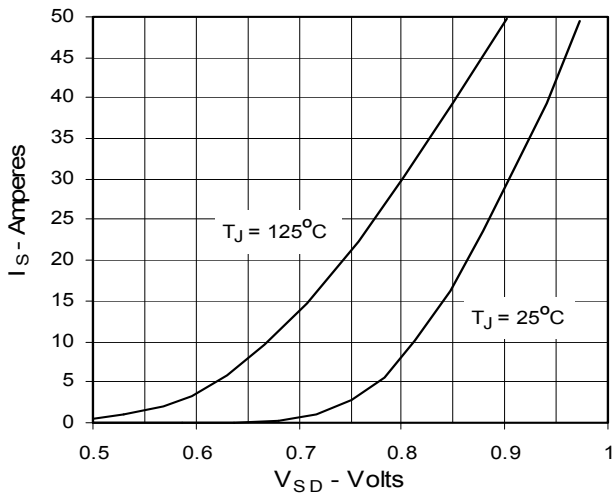

**Fig. 10. Gate Charge**

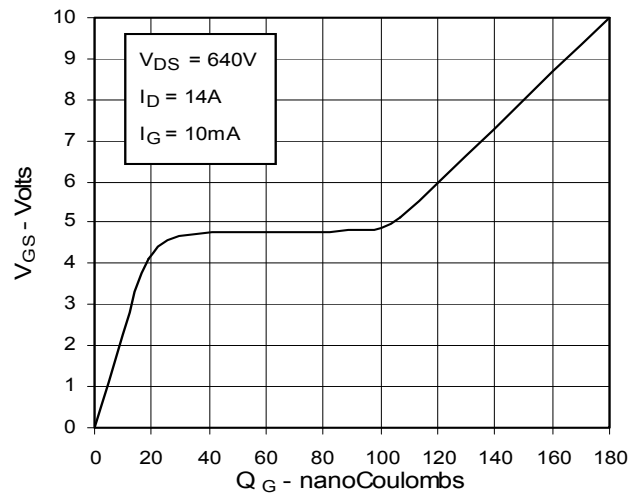

**Fig. 11. Capacitance**

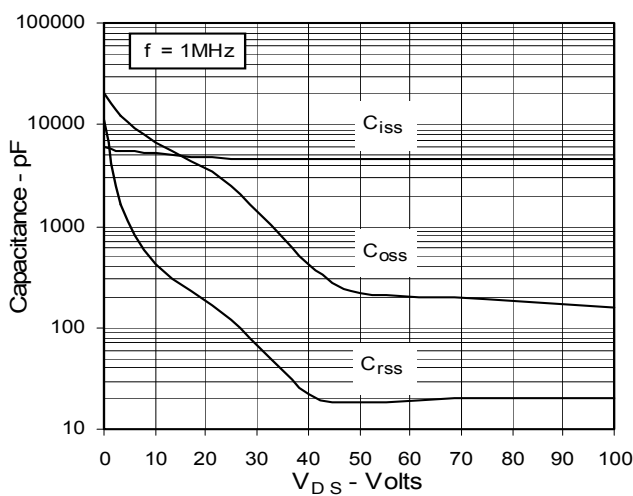

**Fig. 12. Maximum Transient Thermal Resistance**

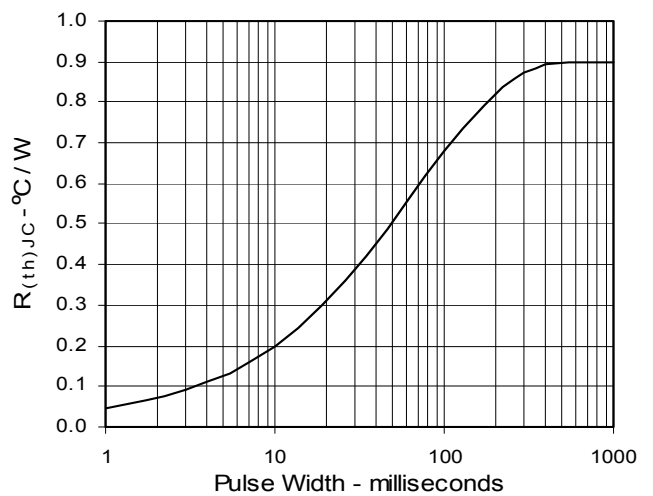

IXYS reserves the right to change limits, test conditions, and dimensions.

IXYS MOSFETs and IGBTs are covered by one or more 4,850,072 4,931,844 5,034,796 5,063,307 5,237,481 5,381,025 6,404,065B1 6,162,665 6,534,343 6,583,505 of the following U.S. patents: 4,835,592 4,881,106 5,017,508 5,049,961 5,187,117 5,486,715 6,306,728B1 6,259,123B1 6,306,728B1 6,683,344