

Features

- Small Size, Low Profile
- Superior Repeatability (Lot-to-Lot Variation)
- Typical Isolation 25 dB
- Typical Insertion Loss 0.8 dB
- Low Cost
- SOIC-16 Package

Description

M/A-COM's DS56-0005 is an IC-based monolithic power divider in a low cost SOIC-16 plastic package. The 6-way power divider is ideally suited for applications where PCB real estate is at a premium and part count reduction and cost are critical. Typical applications include base station switching networks and other cellular equipment, including subscriber units. Available in Tape and Reel.

The DS56-0005 is fabricated using a passive-integrated circuit process. The process features full-chip passivation for increased performance and reliability.

Functional Block Diagram¹

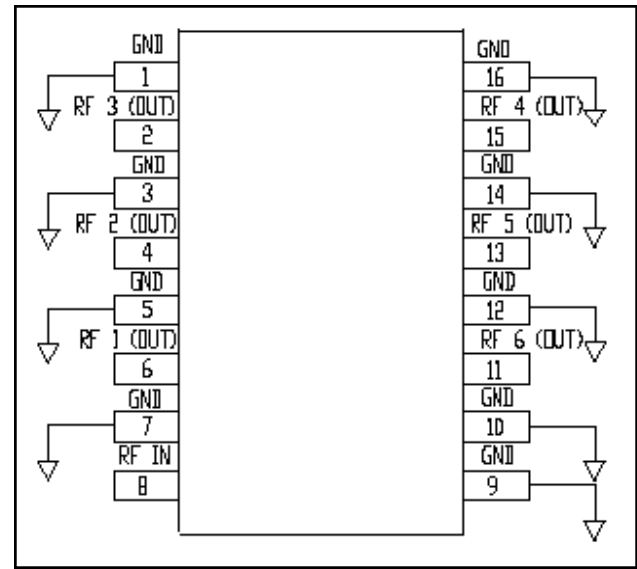

1. All unused pins must be RF and DC grounded.

Ordering Information

Part Number	Package
DS56-0005	Bulk Packaging
DS56-0005-TR	1000 piece reel

Note: Reference Application Note M513 for reel size information.

Pin Configuration

Pin No.	Function	Pin No.	Function
1	GND	9	GND
2	RF 3 (OUT)	10	GND
3	GND	11	RF 6 (OUT)
4	RF 2 (OUT)	12	GND
5	GND	13	RF 5 (OUT)
6	RF 1 (OUT)	14	GND
7	GND	15	RF 4 (OUT)
8	RF IN	16	GND

Electrical Specifications: $T_A = 25^\circ\text{C}$, $Z_0 = 50\Omega$

Parameter	Units	Min	Typ	Max
Insertion Loss above 7.8 dB	dB	—	0.8	1.2
Isolation	dB	20	25	—
VSWR Input	—	—	1.4:1	1.8:1
Output	—	—	1.3:1	1.5:1
Amplitude Balance	dB	—	0.5	0.9
Phase Balance	Deg.	—	4	8

Absolute Maximum Ratings ^{2,3}

Parameter	Absolute Maximum
Input Power ⁴	1 W CW
Operating Temperature	-40°C to +85°C
Storage Temperature	-65°C to +150°C

- Exceeding any one or combination of these limits may cause permanent damage to this device.
- M/A-COM does not recommend sustained operation near these survivability limits.
- With internal load dissipation of 0.125 W maximum.

Handling Procedures

Please observe the following precautions to avoid damage:

Static Sensitivity

GMIC Circuits are sensitive to electrostatic discharge (ESD) and can be damaged by static electricity. Proper ESD control techniques should be used when handling these devices.

Typical Performance Curves

Insertion Loss vs. Frequency

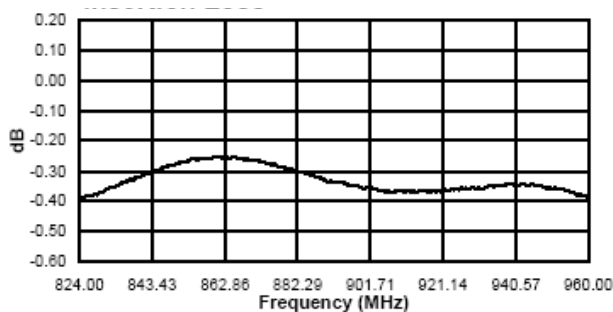

Amplitude Imbalance vs. Frequency

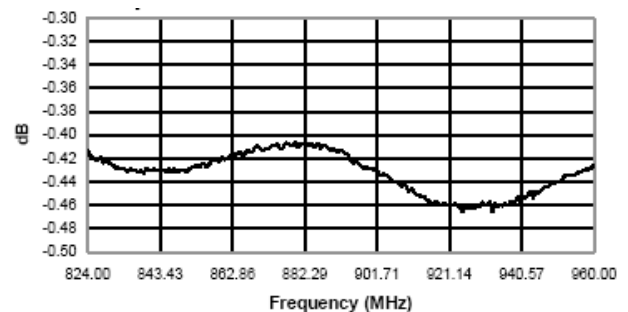

Typical Performance Curves

Isolation vs. Frequency

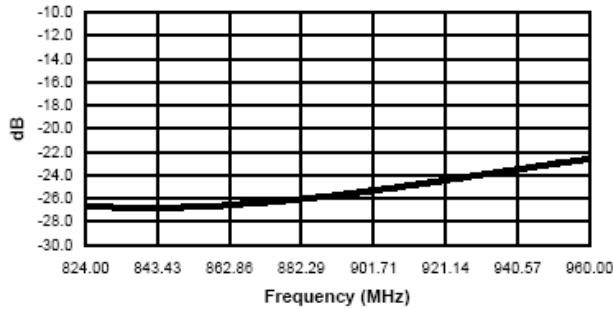

Phase Imbalance vs. Frequency

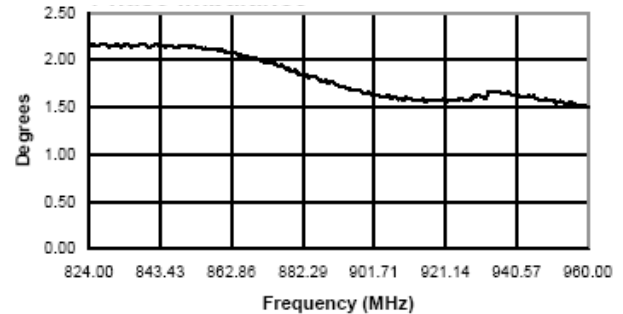

Input VSWR vs. Frequency

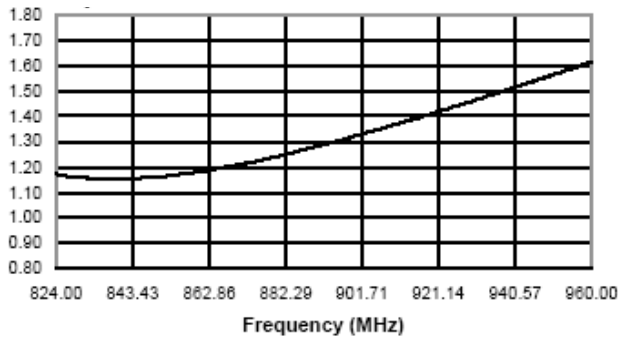

Output VSWR vs. Frequency

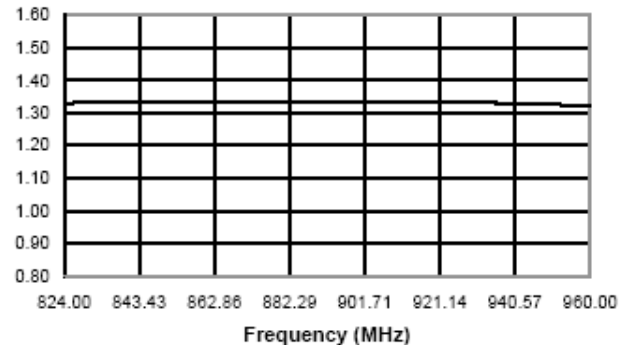

DS56-0005

Low Cost Six-Way Power Divider 824 – 960 MHz

Rev. V4

SOIC-16[†]

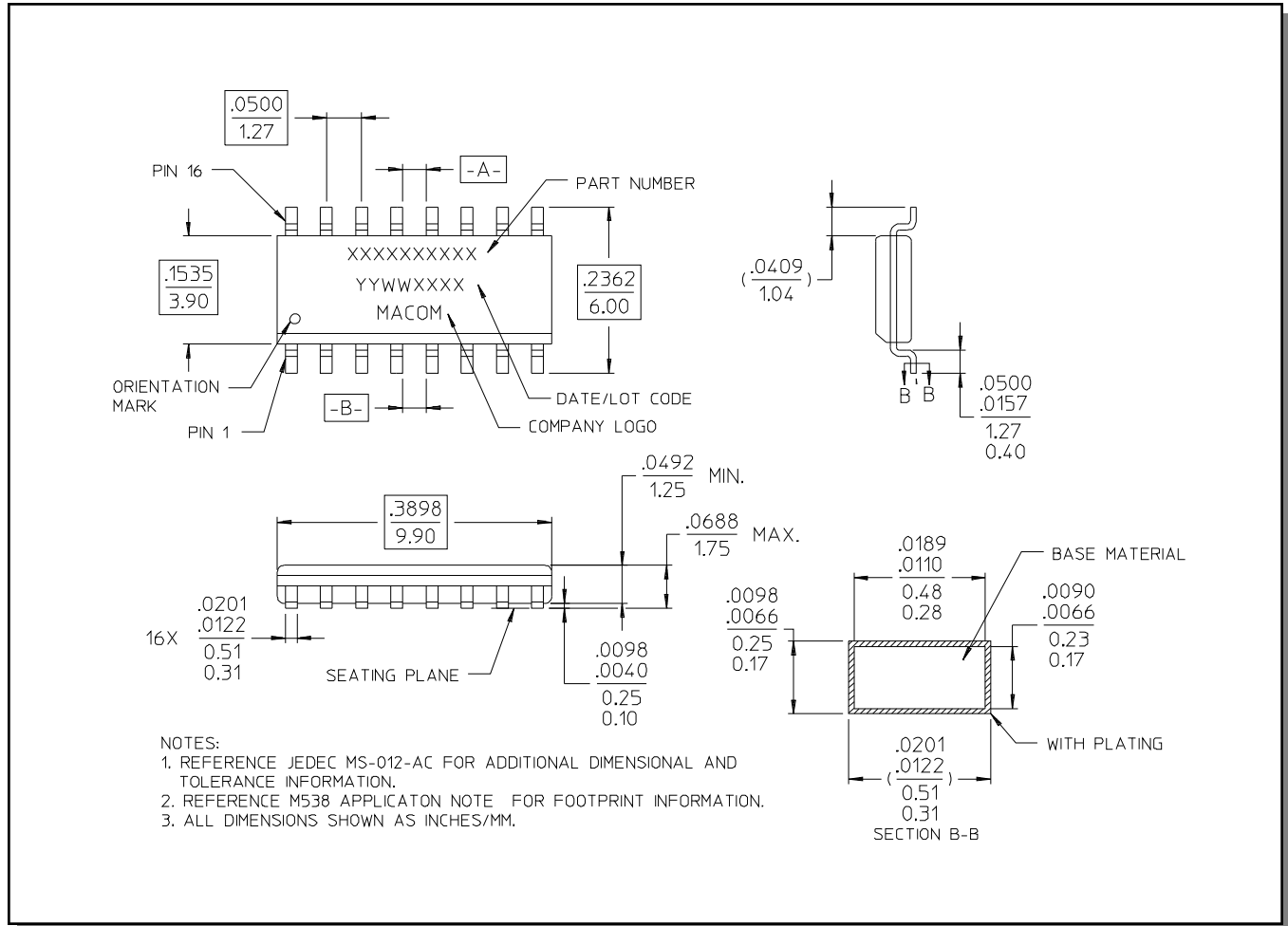

[†] Reference Application Note M538 for lead-free solder reflow recommendations.