

MC3488A

Dual EIA-423/EIA-232D Line Driver

The MC3488A dual is single-ended line driver has been designed to satisfy the requirements of EIA standards EIA-423 and EIA-232D, as well as CCITT X.26, X.28 and Federal Standard FIDS1030. It is suitable for use where signal wave shaping is desired and the output load resistance is greater than 450 Ω. Output slew rates are adjustable from 1.0 μs to 100 μs by a single external resistor. Output level and slew rate are insensitive to power supply variations. Input undershoot diodes limit transients below ground and output current limiting is provided in both output states.

The MC3488A has a standard 1.5 V input logic threshold for TTL or NMOS compatibility.

Features

- PNP Buffered Inputs to Minimize Input Loading
- Short Circuit Protection
- Adjustable Slew Rate Limiting
- MC3488A Equivalent to 9636A
- Output Levels and Slew Rates are Insensitive to Power Supply Voltages
- No External Blocking Diode Required for V_{EE} Supply
- Second Source μA9636A
- Pb-Free Packages are Available

www.DataSheet4U.com



ON Semiconductor®

<http://onsemi.com>

MARKING DIAGRAMS



SOIC-8
D SUFFIX
CASE 751

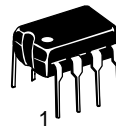
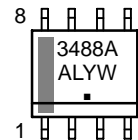

PDIP-8
P1 SUFFIX
CASE 626

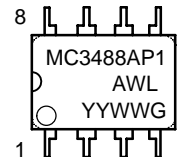

A = Assembly Location
L, WL = Wafer Lot
Y, YY = Year
W, WW = Work Week
▪ or G = Pb-Free Package
(Note: Microdot may be in either location)

PIN CONNECTIONS

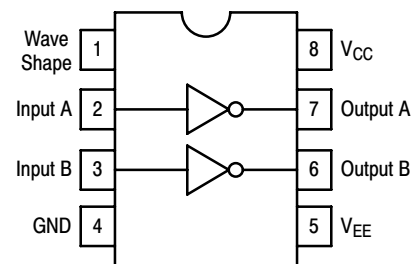

ORDERING INFORMATION

See detailed ordering and shipping information in the package dimensions section on page 3 of this data sheet.

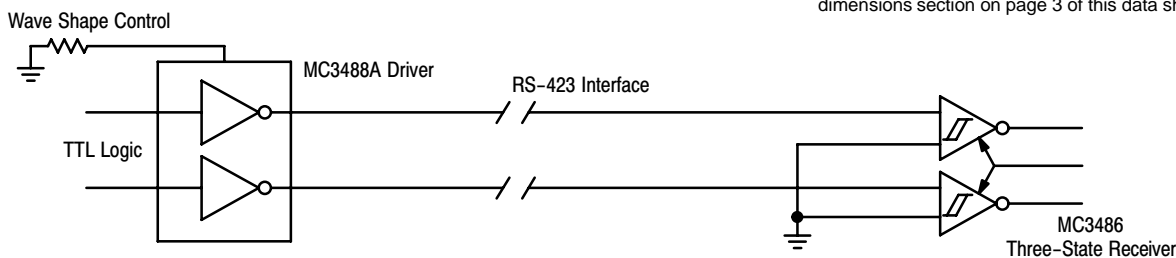

Figure 1. Simplified Application

MC3488A

MAXIMUM RATINGS (Note 1)

| Rating | Symbol | Value | Unit |
|-------------------------------|--|----------------|------|
| Power Supply Voltages | V_{CC} V_{EE} | + 15 – 15 | V |
| Output Current | Source Sink I_{O+} I_{O-} | + 150 – 150 | mA |
| Operating Ambient Temperature | T_A | 0 to + 70 | °C |
| Junction Temperature Range | T_J | 150 | °C |
| Storage Temperature Range | T_{stg} | – 65 to + 150 | °C |

Stresses exceeding Maximum Ratings may damage the device. Maximum Ratings are stress ratings only. Functional operation above the Recommended Operating Conditions is not implied. Extended exposure to stresses above the Recommended Operating Conditions may affect device reliability.

1. Devices should not be operated at these values. The "Electrical Characteristics" provide conditions for actual device operation.

RECOMMENDED OPERATING CONDITIONS

| Characteristic | Symbol | Min | Typ | Max | Unit |
|-----------------------------|----------------------|----------------|------------|----------------|------------|
| Power Supply Voltages | V_{CC} V_{EE} | 10.8 – 13.2 | 12 – 12 | 13.2 – 10.8 | V |
| Operating Temperature Range | T_A | 0 | 25 | 70 | °C |
| Wave Shaping Resistor | R_{WS} | 10 | – | 1000 | k Ω |

TARGET ELECTRICAL CHARACTERISTICS (Unless otherwise noted, specifications apply over recommended operating conditions)

| Characteristic | Symbol | Min | Typ | Max | Unit |
|---|------------------------|-------------------------|-------------|-------------------------|----------|
| Input Voltage – Low Logic State | V_{IL} | – | – | 0.8 | V |
| Input Voltage – High Logic State | V_{IH} | 2.0 | – | – | V |
| Input Current – Low Logic State ($V_{IL} = 0.4$ V) | I_{IL} | – 80 | – | – | μ A |
| Input Current – High Logic State ($V_{IH} = 2.4$ V) ($V_{IH} = 5.5$ V) | I_{IH1} I_{IH2} | – – | – – | 10 100 | μ A |
| Input Clamp Diode Voltage ($I_{IK} = -15$ mA) | V_{IK} | – 1.5 | – | – | V |
| Output Voltage – Low Logic State ($R_L = \infty$), EIA-423 ($R_L = 3.0$ k Ω), EIA-232D ($R_L = 450$ Ω), EIA-423 | V_{OL} | – 6.0 – 6.0 – 6.0 | – – – | – 5.0 – 5.0 – 4.0 | V |
| Output Voltage – High Logic State ($R_L = \infty$), EIA-423 ($R_L = 3.0$ k Ω), EIA-232D ($R_L = 450$ Ω), EIA-423 | V_{OH} | 5.0 5.0 4.0 | – – – | 6.0 6.0 6.0 | V |
| Output Resistance ($R_L \geq 450$ Ω) | R_O | – | 25 | 50 | Ω |
| Output Short-Circuit Current (Note 2) ($V_{in} = V_{out} = 0$ V) ($V_{in} = V_{IH(Min)}$, $V_{out} = 0$ V) | I_{OSH} I_{OSL} | – 150 + 15 | – – | – 15 + 150 | mA |
| Output Leakage Current (Note 3) ($V_{CC} = V_{EE} = 0$ V, -6.0 V $\leq V_o \leq 6.0$ V) | I_{ox} | – 100 | – | 100 | μ A |
| Power Supply Currents ($R_W = 100$ k Ω , $R_L = \infty$, $V_{IL} \leq V_{in} \leq V_{IH}$) | I_{CC} I_{EE} | – – 18 | – – | + 18 – | mA |

2. One output shorted at a time.
3. No V_{EE} diode required.

MC3488A

TRANSITION TIMES (Unless otherwise noted, $C_L = 30$ pF, $f = 1.0$ kHz, $V_{CC} = -V_{EE} = 12.0$ V \pm 10%, $T_A = 25^\circ\text{C}$, $R_L = 450$ Ω . Transition times measured 10% to 90% and 90% to 10%)

| Characteristic | Symbol | Min | Typ | Max | Unit |
|---|-----------|------------------------|-----|------------------------|---------------|
| Transition Time, Low-to-High State Output ($R_W = 10$ k Ω) ($R_W = 100$ k Ω) ($R_W = 500$ k Ω) ($R_W = 1000$ k Ω) | t_{TLH} | 0.8 8.0 40 80 | | 1.4 14 70 140 | μs |
| Transition Time, High-to-Low State Output ($R_W = 10$ k Ω) ($R_W = 100$ k Ω) ($R_W = 500$ k Ω) ($R_W = 1000$ k Ω) | t_{THL} | 0.8 8.0 40 80 | | 1.4 14 70 140 | μs |

ORDERING INFORMATION

| Device | Operating Temperature Range | Package | Shipping [†] |
|-------------|----------------------------------|------------------|-----------------------|
| MC3488AD | $T_A = 0$ to $+70^\circ\text{C}$ | SOIC-8 | 98 Units / Rail |
| MC3488ADG | | SOIC-8 (Pb-Free) | 98 Units / Rail |
| MC3488ADR2 | | SOIC-8 | 1000 / Tape & Reel |
| MC3488ADR2G | | SOIC-8 (Pb-Free) | 1000 / Tape & Reel |
| MC3488AP1 | | PDIP-8 | 50 Units / Rail |
| MC3488AP1G | | PDIP-8 (Pb-Free) | 50 Units / Rail |

[†]For information on tape and reel specifications, including part orientation and tape sizes, please refer to our Tape and Reel Packaging Specifications Brochure, BRD8011/D.

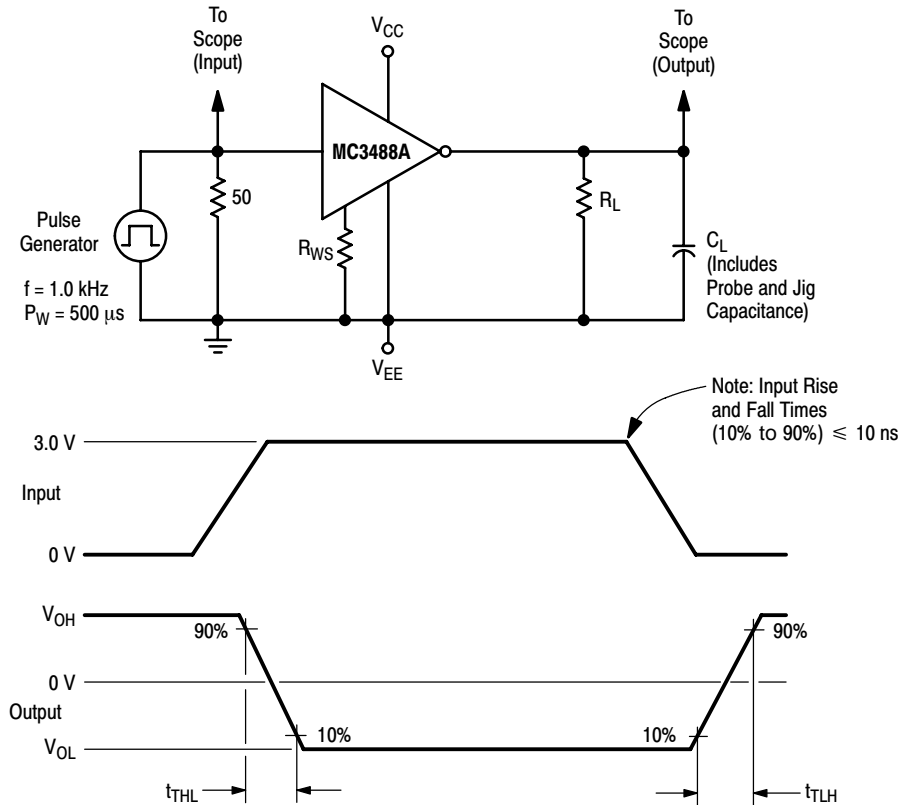

Figure 2. Test Circuit and Waveforms for Transition Times

MC3488A

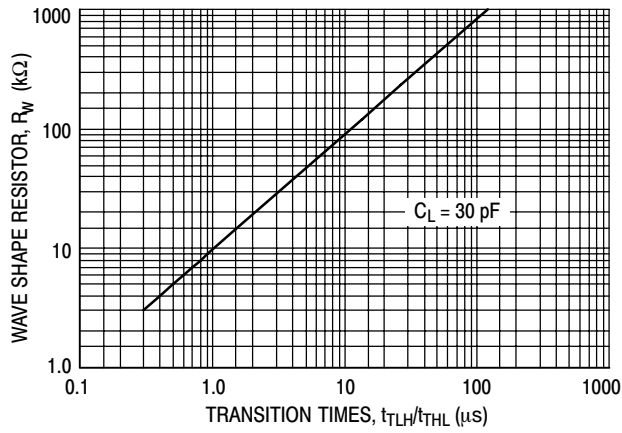

Figure 3. Output Transition Times versus Wave Shape Resistor Value

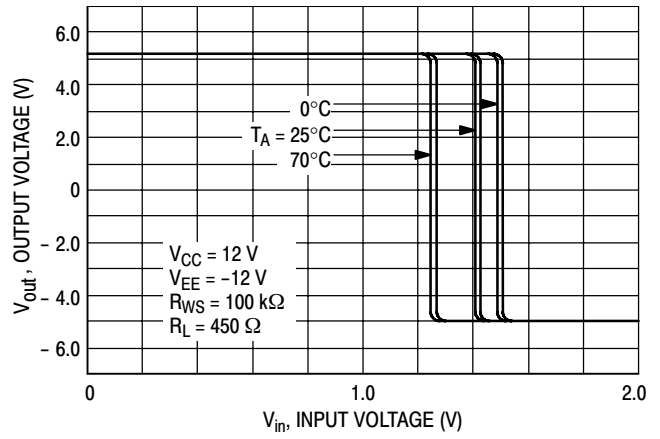

Figure 4. Input/Output Characteristics versus Temperature

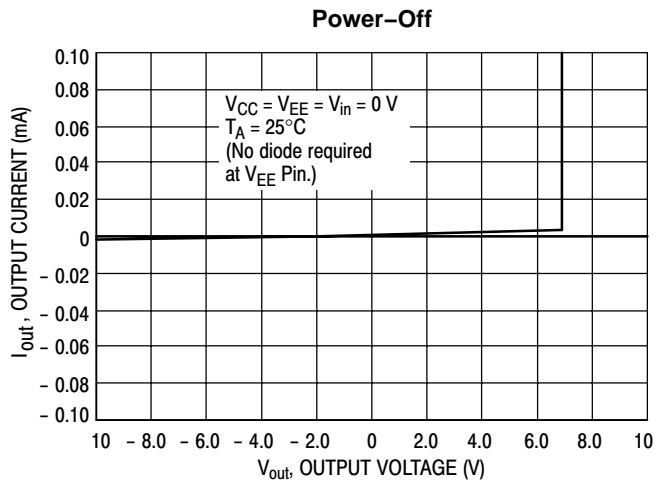
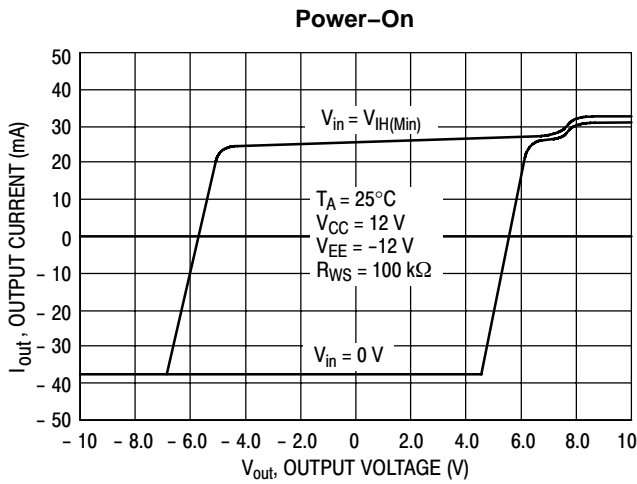

Figure 5. Output Current versus Output Voltage

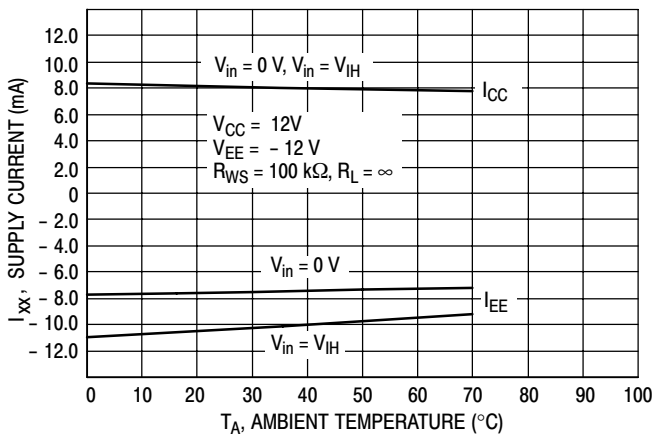

Figure 6. Supply Current versus Temperature

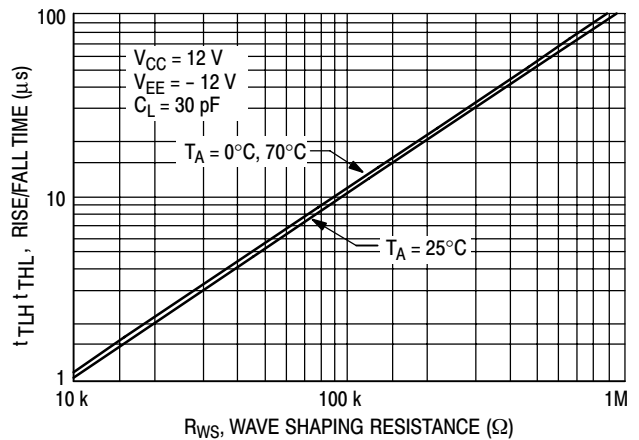
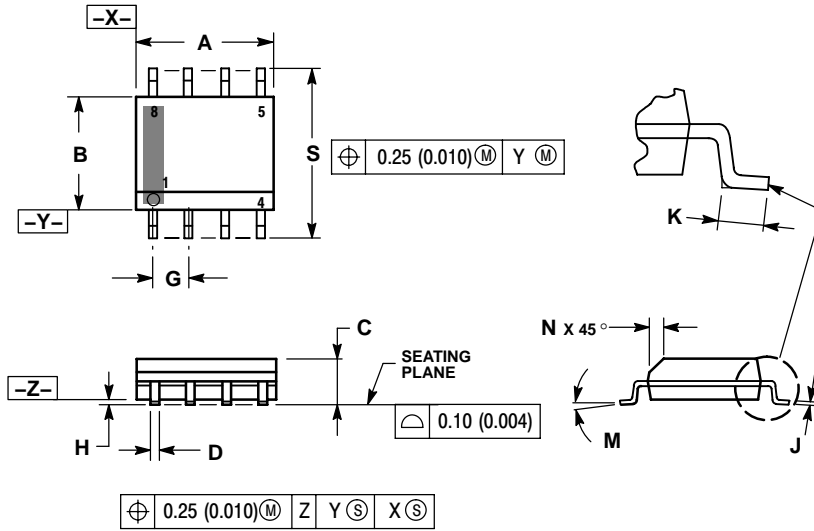

Figure 7. Rise/Fall Time versus R_{ws}

MC3488A

PACKAGE DIMENSIONS

SOIC-8 NB
D SUFFIX
PLASTIC PACKAGE
CASE 751-07
ISSUE AH



NOTES:

1. DIMENSIONING AND TOLERANCING PER ANSI Y14.5M, 1982.
2. CONTROLLING DIMENSION: MILLIMETER.
3. DIMENSION A AND B DO NOT INCLUDE MOLD PROTRUSION.
4. MAXIMUM MOLD PROTRUSION 0.15 (0.006) PER SIDE.
5. DIMENSION D DOES NOT INCLUDE DAMBAR PROTRUSION. ALLOWABLE DAMBAR PROTRUSION SHALL BE 0.127 (0.005) TOTAL IN EXCESS OF THE D DIMENSION AT MAXIMUM MATERIAL CONDITION.
6. 751-01 THRU 751-06 ARE OBSOLETE. NEW STANDARD IS 751-07.

| DIM | MILLIMETERS | | INCHES | |
|-----|-------------|------|-----------|-------|
| | MIN | MAX | MIN | MAX |
| A | 4.80 | 5.00 | 0.189 | 0.197 |
| B | 3.80 | 4.00 | 0.150 | 0.157 |
| C | 1.35 | 1.75 | 0.053 | 0.069 |
| D | 0.33 | 0.51 | 0.013 | 0.020 |
| G | 1.27 BSC | | 0.050 BSC | |
| H | 0.10 | 0.25 | 0.004 | 0.010 |
| J | 0.19 | 0.25 | 0.007 | 0.010 |
| K | 0.40 | 1.27 | 0.016 | 0.050 |
| M | 0 ° | 8 ° | 0 ° | 8 ° |
| N | 0.25 | 0.50 | 0.010 | 0.020 |
| S | 5.80 | 6.20 | 0.228 | 0.244 |

SOLDERING FOOTPRINT*

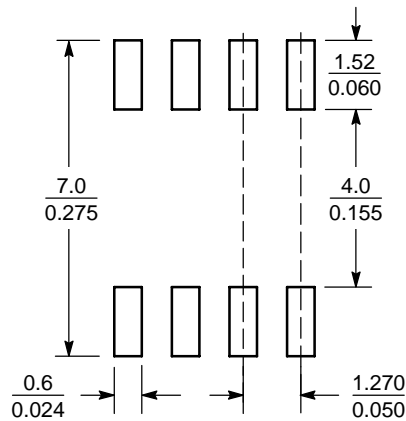

SCALE 6:1 (mm/inches)

*For additional information on our Pb-Free strategy and soldering details, please download the ON Semiconductor Soldering and Mounting Techniques Reference Manual, SOLDERRM/D.

MC3488A

PACKAGE DIMENSIONS

PDIP-8
P1 SUFFIX
PLASTIC PACKAGE
CASE 626-05
ISSUE L

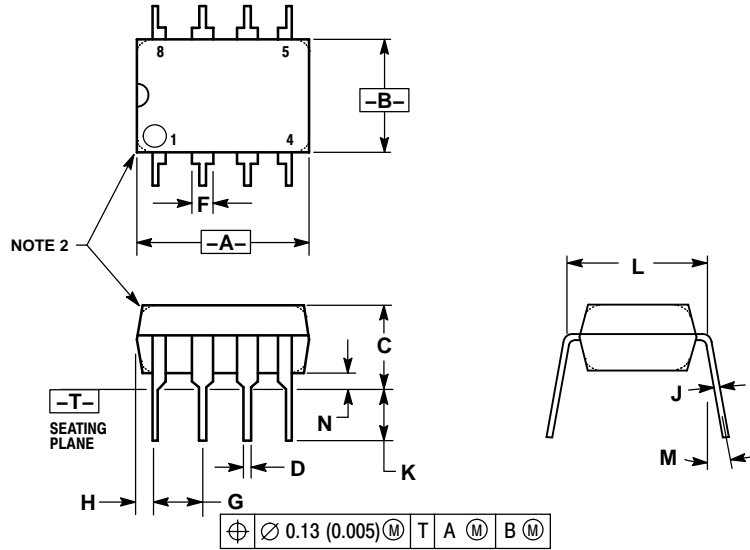

NOTES:

1. DIMENSION L TO CENTER OF LEAD WHEN FORMED PARALLEL.
2. PACKAGE CONTOUR OPTIONAL (ROUND OR SQUARE CORNERS).
3. DIMENSIONING AND TOLERANCING PER ANSI Y14.5M, 1982.

| DIM | MILLIMETERS | | INCHES | |
|-----|-------------|-------|-----------|-------|
| | MIN | MAX | MIN | MAX |
| A | 9.40 | 10.16 | 0.370 | 0.400 |
| B | 6.10 | 6.60 | 0.240 | 0.260 |
| C | 3.94 | 4.45 | 0.155 | 0.175 |
| D | 0.38 | 0.51 | 0.015 | 0.020 |
| F | 1.02 | 1.78 | 0.040 | 0.070 |
| G | 2.54 BSC | | 0.100 BSC | |
| H | 0.76 | 1.27 | 0.030 | 0.050 |
| J | 0.20 | 0.30 | 0.008 | 0.012 |
| K | 2.92 | 3.43 | 0.115 | 0.135 |
| L | 7.62 BSC | | 0.300 BSC | |
| M | --- | 10° | --- | 10° |
| N | 0.76 | 1.01 | 0.030 | 0.040 |

ON Semiconductor and are registered trademarks of Semiconductor Components Industries, LLC (SCILLC). SCILLC reserves the right to make changes without further notice to any products herein. SCILLC makes no warranty, representation or guarantee regarding the suitability of its products for any particular purpose, nor does SCILLC assume any liability arising out of the application or use of any product or circuit, and specifically disclaims any and all liability, including without limitation special, consequential or incidental damages. "Typical" parameters which may be provided in SCILLC data sheets and/or specifications can and do vary in different applications and actual performance may vary over time. All operating parameters, including "Typicals" must be validated for each customer application by customer's technical experts. SCILLC does not convey any license under its patent rights nor the rights of others. SCILLC products are not designed, intended, or authorized for use as components in systems intended for surgical implant into the body, or other applications intended to support or sustain life, or for any other application in which the failure of the SCILLC product could create a situation where personal injury or death may occur. Should Buyer purchase or use SCILLC products for any such unintended or unauthorized application, Buyer shall indemnify and hold SCILLC and its officers, employees, subsidiaries, affiliates, and distributors harmless against all claims, costs, damages, and expenses, and reasonable attorney fees arising out of, directly or indirectly, any claim of personal injury or death associated with such unintended or unauthorized use, even if such claim alleges that SCILLC was negligent regarding the design or manufacture of the part. SCILLC is an Equal Opportunity/Affirmative Action Employer. This literature is subject to all applicable copyright laws and is not for resale in any manner.

PUBLICATION ORDERING INFORMATION

LITERATURE FULFILLMENT:
Literature Distribution Center for ON Semiconductor
P.O. Box 5163, Denver, Colorado 80217 USA
Phone: 303-675-2175 or 800-344-3860 Toll Free USA/Canada
Fax: 303-675-2176 or 800-344-3867 Toll Free USA/Canada
Email: orderlit@onsemi.com

N. American Technical Support: 800-282-9855 Toll Free USA/Canada
Europe, Middle East and Africa Technical Support:
Phone: 421 33 790 2910
Japan Customer Focus Center
Phone: 81-3-5773-3850

ON Semiconductor Website: www.onsemi.com
Order Literature: <http://www.onsemi.com/orderlit>

For additional information, please contact your local Sales Representative