

GaAs MMIC FUNDAMENTAL MIXER, 6 - 26 GHz

Typical Applications

The HMC773 is ideal for:

- Point-to-Point Radios
- Point-to-Multi-Point Radios & VSAT
- Test Equipment & Sensors
- Military End-Use

Features

- Passive: No DC Bias Required
- High Input IP3: +22 dBm
- High LO/Rf Isolation: 38 dB
- Wide IF Bandwidth: DC - 10 GHz
- Upconversion & Downconversion Applications
- Die Size: 1.37 x 0.96 x 0.1 mm

Functional Diagram

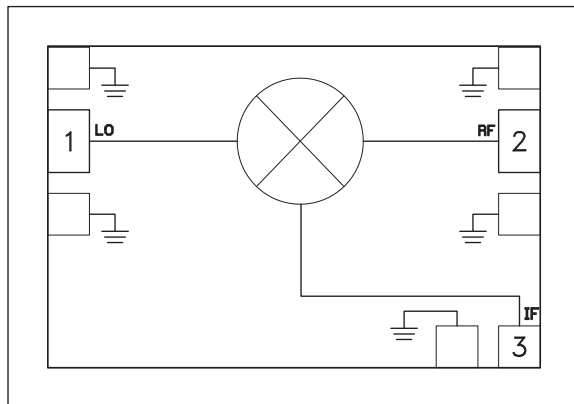

General Description

The HMC773 is a general purpose double balanced mixer chip that can be used as an upconverter or downconverter between 6 and 26 GHz. This mixer requires no external components or matching circuitry. The HMC773 provides excellent LO to RF and LO to IF isolation due to optimized balun structures. The mixer operates with LO drive levels of +13 dBm. The HMC773 wideband mixer exhibits consistent conversion gain and compression across its bandwidth. The HMC773 is also available in SMT format as the HMC773LC3B.

Electrical Specifications, $T_A = +25^\circ \text{C}$, $IF = 0.5 \text{ GHz}$, $LO = +13 \text{ dBm}^*$

Parameter	Min.	Typ.	Max.	Min.	Typ.	Max.	Units
Frequency Range, RF & LO	6 - 16			16 - 26			GHz
Frequency Range, IF	DC - 10			DC - 10			GHz
Conversion Loss		9	12		9	11	dB
LO to RF Isolation		37			38		dB
LO to IF Isolation	31	37		20	30		dB
RF to IF Isolation	5	11		8	18		dB
IP3 (Input)		18			22		dBm
IP2 (Input)		45			50		dBm
1 dB Gain Compression (Input)		10			12		dBm

* Unless otherwise noted, all measurements performed as downconverter, $IF = 0.5 \text{ GHz}$, $LO = +13 \text{ dBm}$

**GaAs MMIC FUNDAMENTAL
MIXER, 6 - 26 GHz**

Conversion Gain vs. Temperature

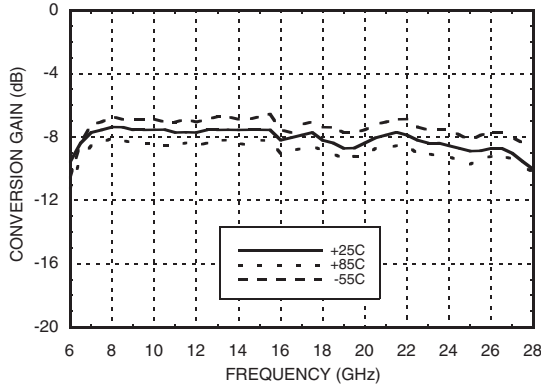

Isolation

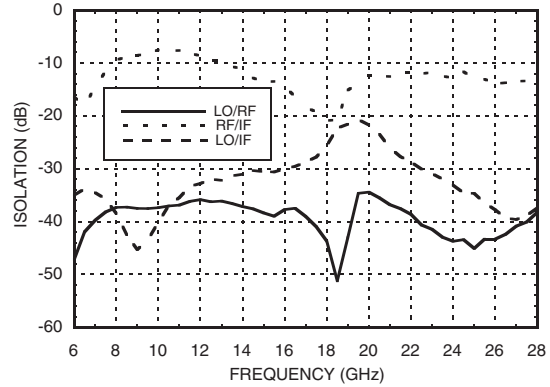

Conversion Gain vs. LO Drive

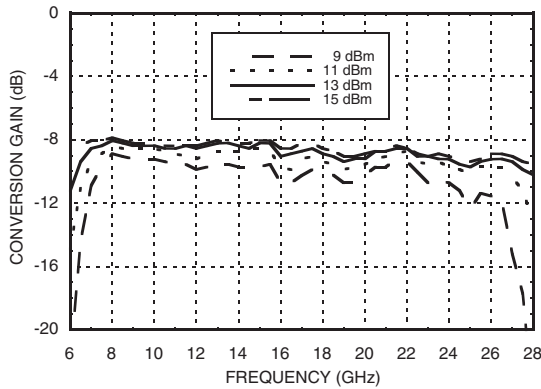

Return Loss

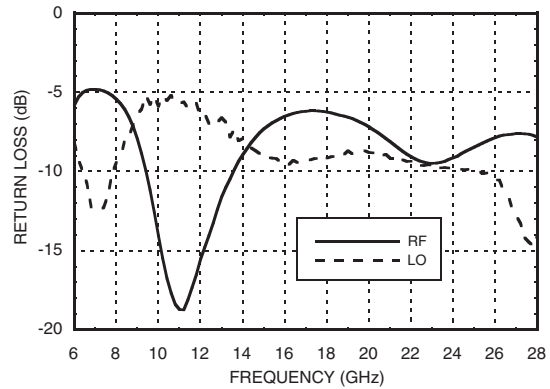

IF Bandwidth vs. Temperature

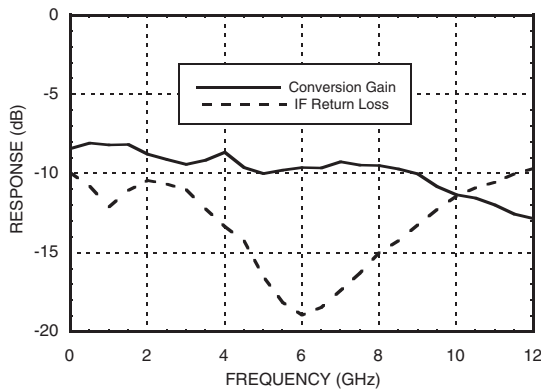

**Upconverter Performance
Conversion Gain vs. LO Drive**

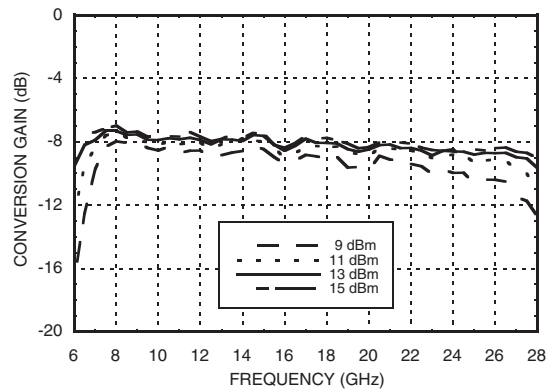

GaAs MMIC FUNDAMENTAL MIXER, 6 - 26 GHz

Input IP3 vs. LO Drive *

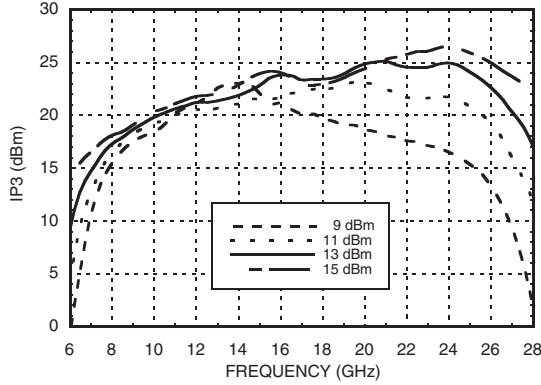

Input IP3 vs. Temperature*

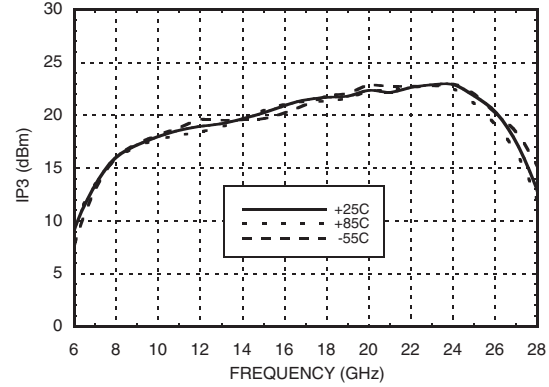

Input IP2 vs. LO Drive *

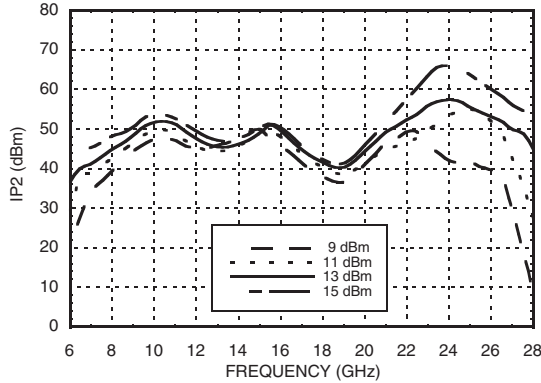

Input IP2 vs. Temperature *

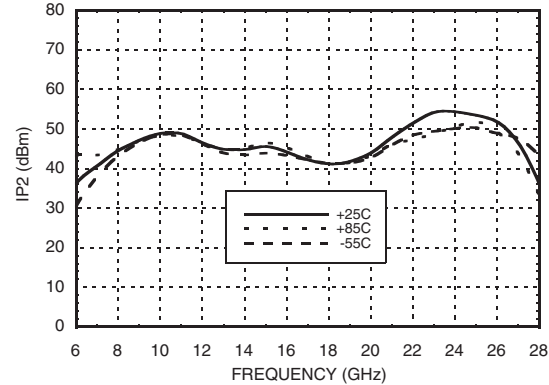

Input P1dB vs. LO Drive

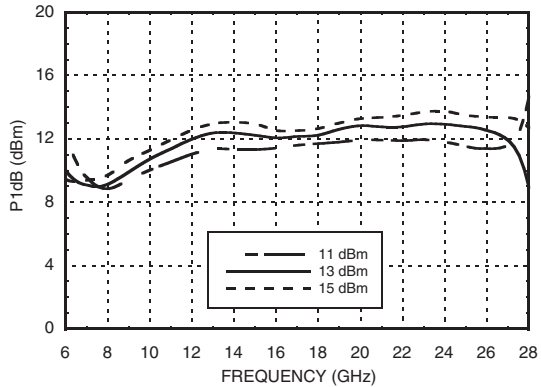

Input P1dB vs. Temperature

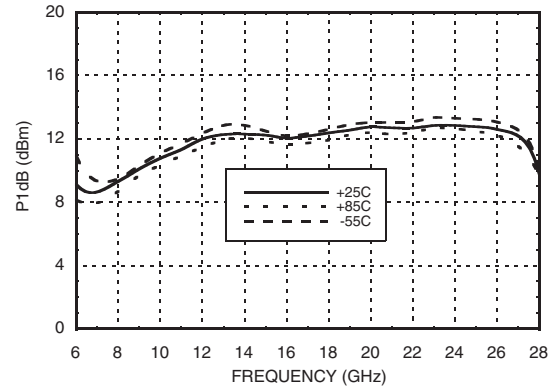

* Two-tone input power = -5 dBm each tone, 1 MHz spacing.

GaAs MMIC FUNDAMENTAL MIXER, 6 - 26 GHz

MxN Spurious Outputs

mRF	nLO				
	0	1	2	3	4
0	XX	14.5	30.3	31.3	53.3
1	0	0	21.6	22.5	46.7
2	69.0	61.7	62.5	63.7	74.6
3	>100	79.4	65.8	68.2	59.6

RF = 18 GHz @ -10 dBm
 LO = 17 GHz @ +13 dBm
 All values in dBc below the IF output power level.

Absolute Maximum Ratings

RF / IF Input	+21 dBm
LO Drive	+21 dBm
Channel Temperature	150 °C
Continuous P _{diss} (Ta = 85 °C) (derate 3.26 mW/°C above 85 °C)	212 mW
Thermal Resistance (junction to die bottom)	306 °C/W
Storage Temperature	-65 to +150 °C
Operating Temperature	-55 to +85 °C



ELECTROSTATIC SENSITIVE DEVICE
OBSERVE HANDLING PRECAUTIONS

Outline Drawing

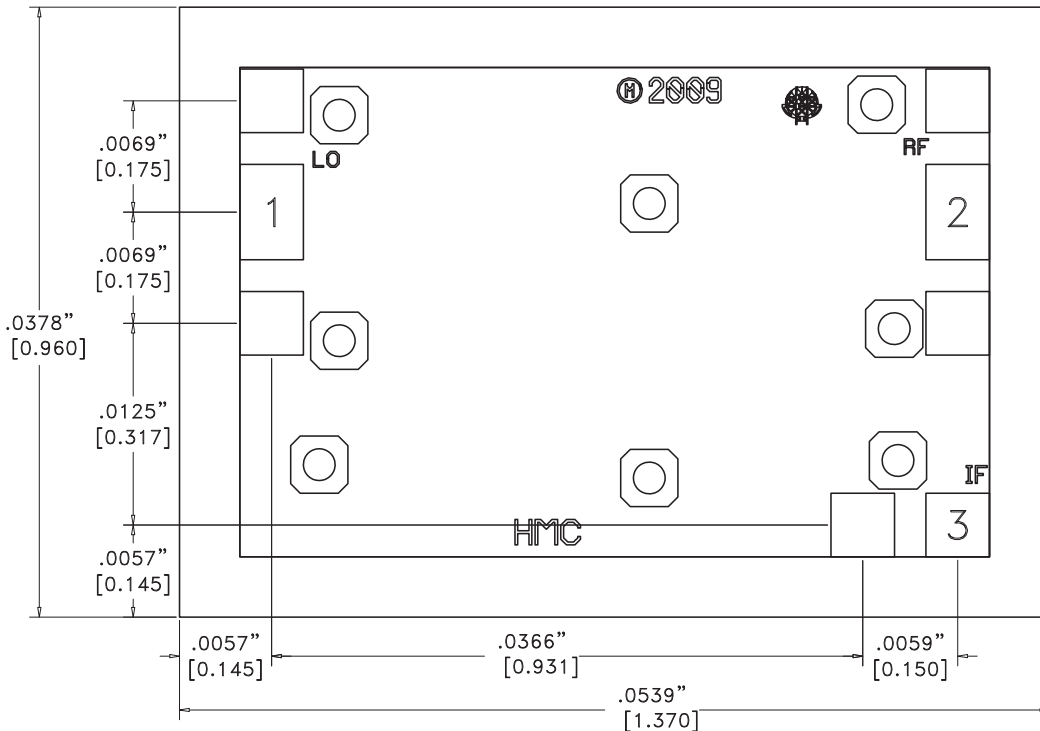

Pad Descriptions

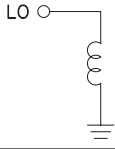
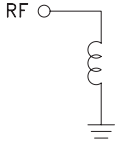
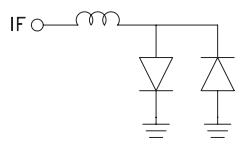
Pad Number	Function	Description	Interface Schematic
1	LO	This pin is DC coupled and matched to 50 Ohms.	
2	RF	This pin is DC coupled and matched to 50 Ohms.	
3	IF	This pin is DC coupled. For applications not requiring operation to DC, this port should be DC blocked externally using a series capacitor whose value has been chosen to pass the necessary IF frequency range. For operation to DC, this pin must not source or sink more than 2 mA of current or part non-function and possible part failure will result.	

Assembly Diagram

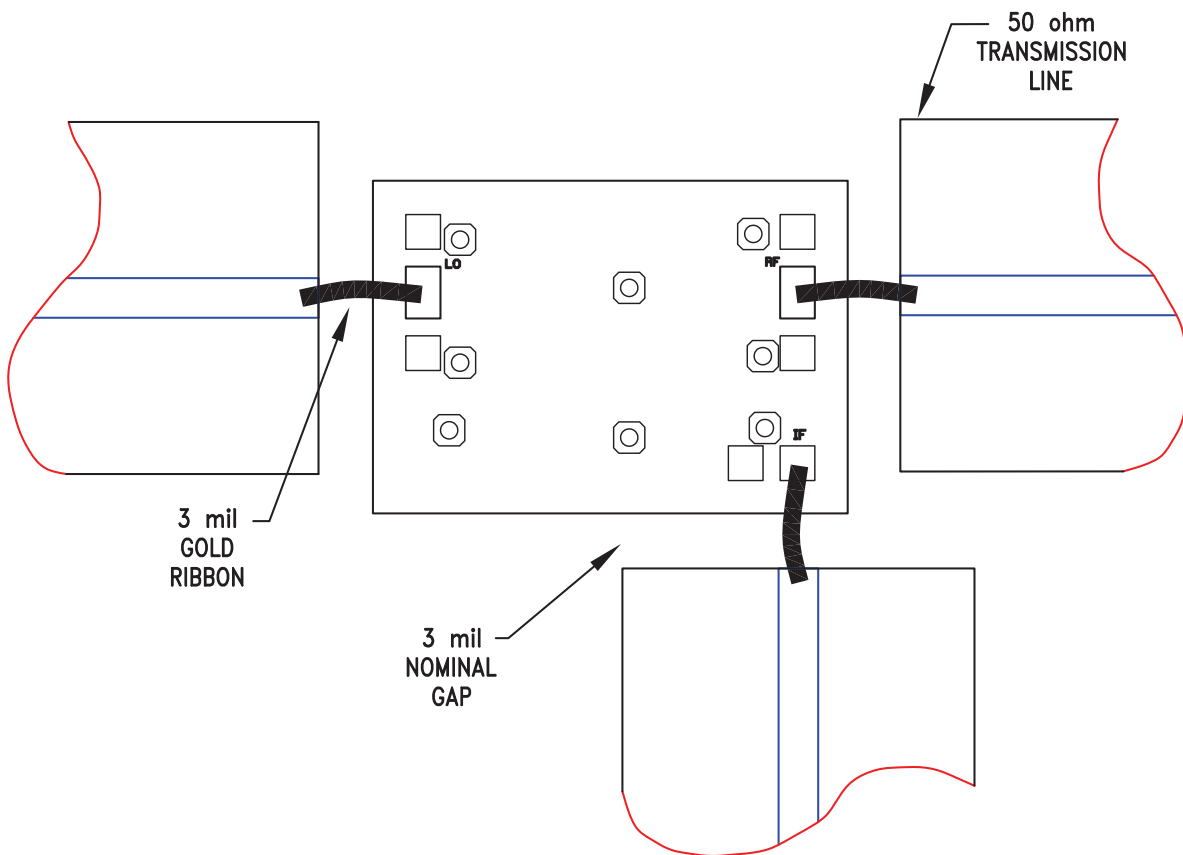

**GaAs MMIC FUNDAMENTAL
MIXER, 6 - 26 GHz**

Mounting & Bonding Techniques for Millimeterwave GaAs MMICs

The die should be attached directly to the ground plane eutectically or with conductive epoxy (see HMC general Handling, Mounting, Bonding Note).

50 Ohm Microstrip transmission lines on 0.127mm (5 mil) thick alumina thin film substrates are recommended for bringing RF to and from the chip (Figure 1). If 0.254mm (10 mil) thick alumina thin film substrates must be used, the die should be raised 0.150mm (6 mils) so that the surface of the die is coplanar with the surface of the substrate. One way to accomplish this is to attach the 0.102mm (4 mil) thick die to a 0.150mm (6 mil) thick molybdenum heat spreader (moly-tab) which is then attached to the ground plane (Figure 2).

Microstrip substrates should be brought as close to the die as possible in order to minimize ribbon bond length. Typical die-to-substrate spacing is 0.076mm (3 mils). Gold ribbon of 0.075 mm (3 mil) width and minimal length <0.31 mm (<12 mils) is recommended to minimize inductance on RF, LO & IF ports.

Handling Precautions

Follow these precautions to avoid permanent damage.

Storage: All bare die are placed in either Waffle or Gel based ESD protective containers, and then sealed in an ESD protective bag for shipment. Once the sealed ESD protective bag has been opened, all die should be stored in a dry nitrogen environment.

Cleanliness: Handle the chips in a clean environment. DO NOT attempt to clean the chip using liquid cleaning systems.

Static Sensitivity: Follow ESD precautions to protect against > ±250V ESD strikes.

Transients: Suppress instrument and bias supply transients while bias is applied. Use shielded signal and bias cables to minimize inductive pick-up.

General Handling: Handle the chip along the edges with a vacuum collet or with a sharp pair of bent tweezers. The surface of the chip has fragile air bridges and should not be touched with vacuum collet, tweezers, or fingers.

Mounting

The chip is back-metallized and can be die mounted with AuSn eutectic preforms or with electrically conductive epoxy. The mounting surface should be clean and flat.

Eutectic Die Attach: A 80/20 gold tin preform is recommended with a work surface temperature of 255 °C and a tool temperature of 265 °C. When hot 90/10 nitrogen/hydrogen gas is applied, tool tip temperature should be 290 °C. DO NOT expose the chip to a temperature greater than 320 °C for more than 20 seconds. No more than 3 seconds of scrubbing should be required for attachment.

Epoxy Die Attach: Apply a minimum amount of epoxy to the mounting surface so that a thin epoxy fillet is observed around the perimeter of the chip once it is placed into position. Cure epoxy per the manufacturer's schedule.

Wire Bonding

RF bonds made with 0.003" x 0.0005" ribbon are recommended. These bonds should be thermosonically bonded with a force of 40-60 grams. DC bonds of 0.001" (0.025 mm) diameter, thermosonically bonded, are recommended. Ball bonds should be made with a force of 40-50 grams and wedge bonds at 18-22 grams. All bonds should be made with a nominal stage temperature of 150 °C. A minimum amount of ultrasonic energy should be applied to achieve reliable bonds. All bonds should be as short as possible, less than 12 mils (0.31 mm).

