

PLEASE CHECK WWW.MOLEX.COM FOR LATEST PART INFORMATION

Part Number: [0872632823](#)
Status: **Active**
Description: 2.00mm (.079") Pitch Milli-Grid™ Receptacle, Surface Mount, Bottom Entry, 0.38µm (15µ") Gold (Au) Selective, 28 Circuits, without Pick-and-Place Cap, Tube, Leadfree

Documents:

[3D Model](#)
[Drawing \(PDF\)](#)

[RoHS Certificate of Compliance \(PDF\)](#)

Agency Certification

CSA LR19980
 UL E29179

General

Product Family PCB Receptacles
 Series [87263](#)
 Application Board-to-Board
 Product Literature Order No 987650-1991
 Product Name Milli-Grid™

Physical

Circuits (Loaded) 28
 Color - Resin Black
 Durability (mating cycles max) 25
 Flammability 94V-0
 Glow-Wire Compliant No
 Lock to Mating Part None
 Material - Plating Mating Gold
 Material - Plating Termination Tin
 Material - Resin High Temperature Thermoplastic
 Number of Rows 2
 Orientation Bottom Entry
 PCB Locator Yes
 PCB Retention None
 Packaging Type Tube
 Pitch - Mating Interface (in) 0.079 In
 Pitch - Mating Interface (mm) 2.00 mm
 Pitch - Term. Interface (in) 0.079 In
 Pitch - Term. Interface (mm) 2.00 mm
 Plating min: Mating (µin) 15.2
 Plating min: Mating (µm) 0.38
 Polarized to Mating Part No
 Polarized to PCB Yes
 Temperature Range - Operating -55°C to +105°C
 Termination Interface: Style Surface Mount

Electrical

Current - Maximum per Contact 1A
 Voltage - Maximum 125V

Solder Process Data

Lead-free Process Capability Reflow Capable (SMT only)
 Process Temperature max. C 260

Material Info

Reference - Drawing Numbers

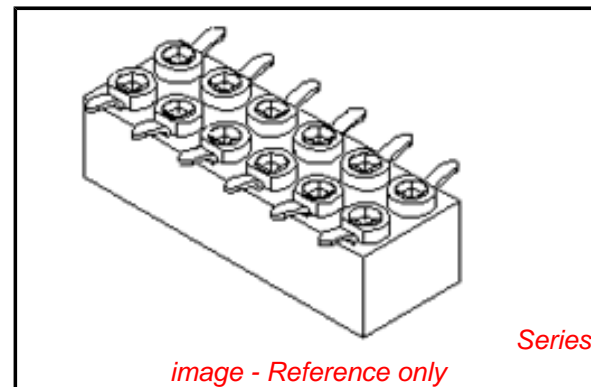

EU RoHS

ELV and RoHS Compliant
REACH SVHC Contains SVHC: No
Halogen-Free Status
Not Reviewed

China RoHS



Need more information on product environmental compliance?

Email productcompliance@molex.com
 For a multiple part number RoHS Certificate of Compliance, [click here](#)

Please visit the [Contact Us](#) section for any non-product compliance questions.

Search Parts in this Series

[87263Series](#)

Mates With

[87759](#) Vertical, Surface Mount, Stackable PCB Headers, [87760](#) Right Angle, Through Hole, Stackable PCB Headers, [87758](#) Vertical, Through Hole, Stackable PCB Headers

This document was generated on 04/27/2010

PLEASE CHECK WWW.MOLEX.COM FOR LATEST PART INFORMATION

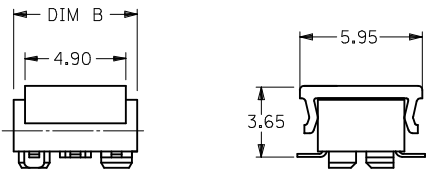
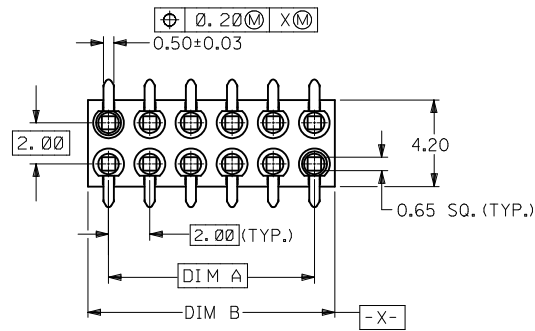
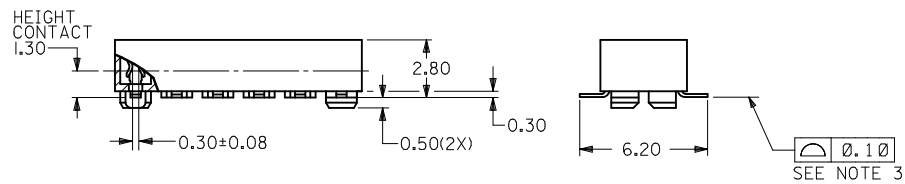

PARTS TO BE PACK WITH CAP (12 CKT SHOWN)

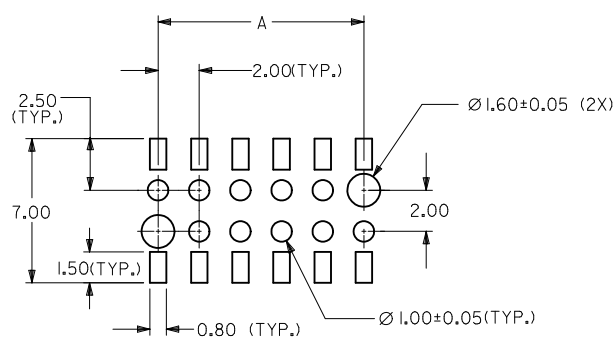

RECOMMENDED SOLDER PAD DESIGN

PART NO. LEGEND

87263 - * * * *

- CIRCUIT SIZE
- PLATING OPTION
 3 - 0.38um MIN. GOLD
 5 - 0.76um MIN. GOLD
 6 - (0.13-0.38)um GOLD FLASH
- PACKAGING
 0 - W/CAP IN TUBE (SEE SHEET 2)
 2 - W/O CAP IN TUBE (SEE SHEET 2)
 9 - W/CAP IN TAPE & REEL (SEE SHEET 3)

CKT. SIZE	DIM. A	DIM. B
4	2.00	4.00
6	4.00	6.00
8	6.00	8.00
10	8.00	10.00
12	10.00	12.00
14	12.00	14.00
16	14.00	16.00
18	16.00	18.00
20	18.00	20.00
22	20.00	22.00
24	22.00	24.00
26	24.00	26.00
28	26.00	28.00
30	28.00	30.00
32	30.00	32.00
34	32.00	34.00
36	34.00	36.00
38	36.00	38.00
40	38.00	40.00
42	40.00	42.00
44	42.00	44.00

NOTES:

- FOR ILLUSTRATION PURPOSES, DRAWING SHOWS PART WITH 12 CIRCUIT SIZE.
- PLATING
 POST-PLATING - SELECTIVE GOLD (SEE LEGEND) AT CONTACT AREA, AND 1.27um MIN. SELECTIVE TIN AT SOLDER AREA BOTH OVER 1.27um MIN. NICKEL OVERALL.
- CO-PLANARITY OF P.C TAIL TO BE MEASURED BY RESTING THE PART ON A FLAT GAGE SURFACE.
- PRODUCT SPECIFICATION PS-87263 APPLIES.
- CAP : HIGH TEMPERATURE THERMOPLASTIC, UL RATED 94V-0, SUITABLE FOR SURFACE-MOUNT SOLDERING PROCESS. COLOR BLACK
- POSITION OF CAP TO BE CENTRAL WITH RESPECT TO DIMENSION " A "
- CONTACT FACTORY FOR DETAILS ON THIS PART NO.
- PARTS SHALL BE PACKED IN MOISTURE BARRIER BAG.

ADD 32CKT T&R INFO EC NO: S2010-0732 DRWN:SKANG 2010/03/08 CHKD:ATSEE 2010/03/18 APPR:MLONG 2010/03/22	QUALITY SYMBOLS ▽=0 ◻=0	GENERAL TOLERANCES (UNLESS SPECIFIED)		DIMENSION STYLE MM ONLY		SCALE NTS	DESIGN UNITS METRIC	THIRD ANGLE PROJECTION		
			mm	INCH	DRAWN BY	DATE	TITLE			
		4 PLACES	± ---	± ---	JDK	1991/01/11	MGRID, B/ENTRY RECEPT. 2.80MM HT. W/LOC. PEGS W/CAP, SMT			
		3 PLACES	± ---	± ---	CHECKED BY	DATE				
2 PLACES	± 0.20	± ---	MLA1	1991/01/11	MOLEX INCORPORATED					
1 PLACE	± ---	± ---	APPROVED BY	DATE						
ANGULAR ± 3 °		DRAFT WHERE APPLICABLE MUST REMAIN WITHIN DIMENSIONS		MATERIAL NO.		DOCUMENT NO.		SHEET NO.		
				SEE TABLE		SD-87263-**2*		1 OF 3		
THIS DRAWING CONTAINS INFORMATION THAT IS PROPRIETARY TO MOLEX INCORPORATED AND SHOULD NOT BE USED WITHOUT WRITTEN PERMISSION										

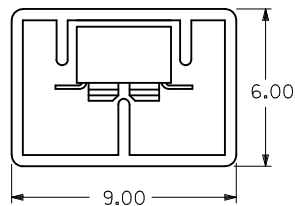
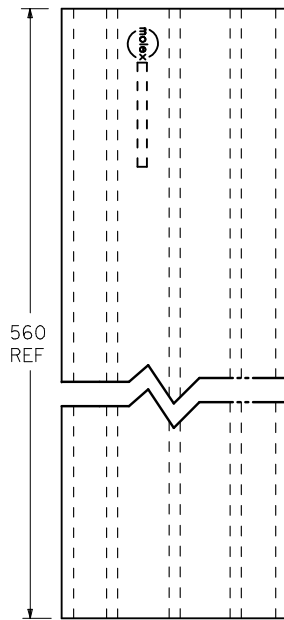

P/N 87263-**-**2*

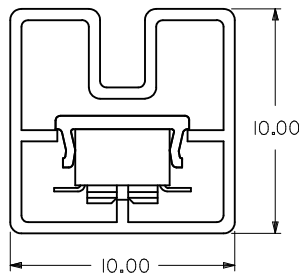
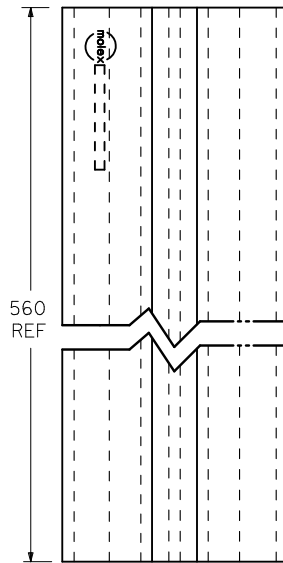

P/N 87263-**-**0*

CKT. SIZE	PART NO. FOR PARTS WITHOUT CAP	△ PART NO. FOR PARTS WITH CAP
4	87263-042*	87263-040*
6	87263-062*	87263-060*
8	87263-082*	87263-080*
10	87263-102*	87263-100*
12	87263-122*	87263-120*
14	87263-142*	87263-140*
16	87263-162*	87263-160*
18	87263-182*	87263-180*
20	87263-202*	87263-200*
22	87263-222*	87263-220*
24	87263-242*	87263-240*
26	87263-262*	87263-260*
28	87263-282*	87263-280*
30	87263-302*	87263-300*
32	87263-322*	87263-320*
34	87263-342*	87263-340*
36	87263-362*	87263-360*
38	87263-382*	87263-380*
40	87263-402*	87263-400*
42	87263-422*	87263-420*
44	△ 87263-442*	87263-440*

ADD 32CKT T&R INFO EC NO: S2010-0732 DRWN:SKANG 2010/03/08 CHKD:ATSEE 2010/03/18 APPR:MLONG 2010/03/22	QUALITY SYMBOLS	GENERAL TOLERANCES (UNLESS SPECIFIED)	DIMENSION STYLE		SCALE	DESIGN UNITS	THIRD ANGLE PROJECTION	
	▽=0		mm	INCH	NTS	METRIC		
	∇=0		DRAWN BY		DATE	TITLE		
			CHECKED BY		DATE	MGRID, B/ENTRY RECEPT. 2.80MM HT. W/LOC. PEGS W/CAP, SMT		
		4 PLACES ± --- ± ---	JDK	1991/01/11	MOLEX INCORPORATED			
		3 PLACES ± --- ± ---	MLA1	1991/01/11	MOLEX INCORPORATED			
		2 PLACES ± 0.20 ± ---	APPROVED BY	DATE	MOLEX INCORPORATED			
		1 PLACE ± --- ± ---	MLONG	2010/03/19	MOLEX INCORPORATED			
		ANGULAR ± 3 °	MATERIAL NO.	SEE TABLE	DOCUMENT NO.		SHEET NO.	
					SD-87263-**-**2*		2 OF 3	
					THIS DRAWING CONTAINS INFORMATION THAT IS PROPRIETARY TO MOLEX INCORPORATED AND SHOULD NOT BE USED WITHOUT WRITTEN PERMISSION			

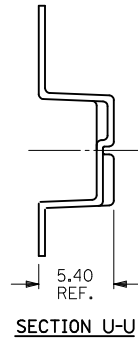
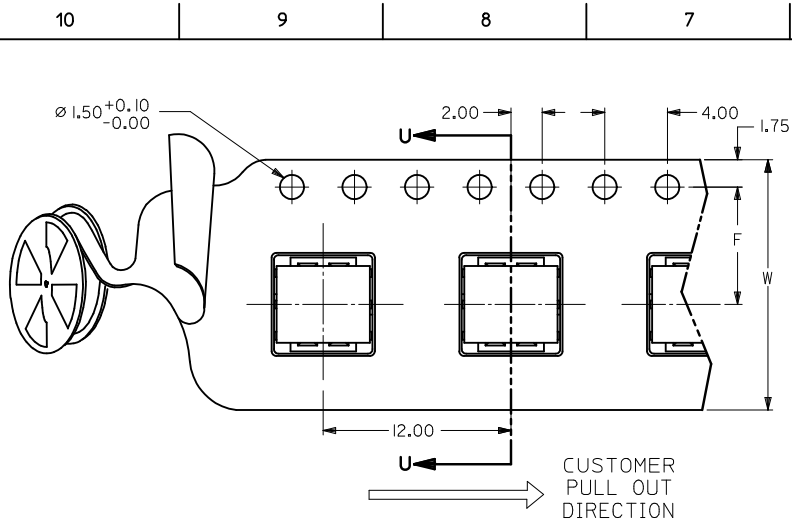

PART NO. 87263-***9* (CKTS 04 TO 14)
SINGLE SPROCKET HOLE T/REEL - TYPE A

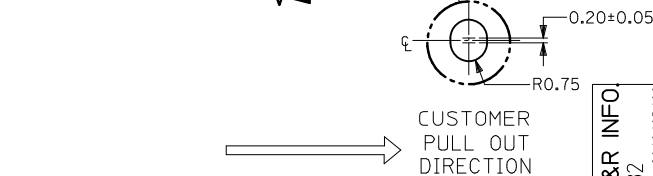
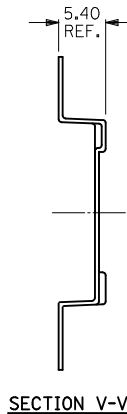
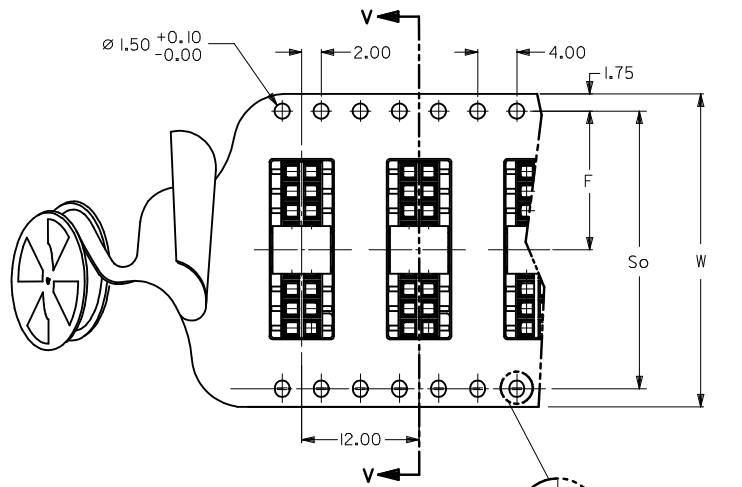

PART NO. 87263-***9* (CKTS 16 TO 40)
DOUBLE SPROCKET HOLE T/REEL - TYPE B

△ PART NO. FOR PARTS IN T/REEL	CKT. SIZE	F	So	W	T/REEL TYPE
87263-049*	4	11.5	-	24	A
87263-069*	6	11.5	-	24	
87263-089*	8	11.5	-	24	
87263-109*	10	11.5	-	24	
87263-129*	12	11.5	-	24	
87263-149*	14	11.5	-	24	
87263-169*	16	11.5	-	24	
87263-189*	18	14.2	28.4	32	
87263-209*	20	20.2	40.4	44	
87263-229*	22	-	-	-	
87263-249*	24	20.2	40.4	44	
87263-269*	26	20.2	40.4	44	
87263-289*	28	20.2	40.4	44	
87263-309*	30	20.2	40.4	44	
87263-329*	32	26.2	52.4	56	
87263-349*	34	-	-	-	
87263-369*	36	26.2	52.4	56	
87263-389*	38	-	-	-	
87263-409*	40	-	-	-	

- NOTES:
- LEADER AND TRAILER TAPE
 - PEELING OFF FORCE OF THE TOP TAPE: 20-80gf.
 (PEELING DIRECTION AS SHOWN IN FOLLOWING FIGURE)
 - PACKAGING STANDARD IS AS PER EIA-481.
 - TAPE & REEL QUANTITY = 1000PCS/REEL.
 - THE TAPE IS TREATED FOR ANTI-STATIC.

ADD 32CKT T&R INFO EC NO: S2010-0732 DRWN:SKANG 2010/03/08 CHKD:ATSEE 2010/03/18 APPR:MLONG 2010/03/22	QUALITY SYMBOLS	GENERAL TOLERANCES (UNLESS SPECIFIED)	DIMENSION STYLE	SCALE	DESIGN UNITS	THIRD ANGLE PROJECTION	
	▽=0 ∠=0	mm INCH	MM ONLY	NTS	METRIC		
		4 PLACES ± --- ± --- 3 PLACES ± --- ± --- 2 PLACES ± 0.20 ± --- 1 PLACE ± --- ± ---	DRAWN BY DATE JDK 1991/01/11	TITLE	MGRID, B/ENTRY RECEPT. 2.80MM HT. W/LOC. PEGS W/CAP, SMT		
		ANGULAR ± 3 °	CHECKED BY DATE MLA1 1991/01/11		MOLEX MOLEX INCORPORATED		
		DRAFT WHERE APPLICABLE MUST REMAIN WITHIN DIMENSIONS	MATERIAL NO.	DOCUMENT NO.	SHEET NO.		
			SEE TABLE		SD-87263-***2*		
			SIZE A3	THIS DRAWING CONTAINS INFORMATION THAT IS PROPRIETARY TO MOLEX INCORPORATED AND SHOULD NOT BE USED WITHOUT WRITTEN PERMISSION			