



Product Features

- Integrated Monolithic GaAs Converter Package Module
- High Reliability
- Lower Manufacturing Cost
- Higher Productivity
- Very Low Noise Figure & Low Distortion
- Very Low Phase Noise (Ceramic Resonator used)
- Pb Free / RoHS Standard

Application

- Repeater
- Base Station



Package Type: HY-5A

Description

GSM Mixer is a very compact size due to using simple matching circuit board including PLL circuits. Customers can apply this part to GSM systems

Specifications

(Operating Temperature: -30°C~+80°C)

PARAMETER	RFUR09-50 (Rx-Up)	RFDR09-51 (Rx-Down)	RFDR09-55 (Tx-Down)	RFUR09-56 (Tx-Up)
Input Frequency Range (MHz)	70 (IF)	890~915 (RF)	935~960 (RF)	70 (IF)
Output Frequency Range (MHz)	890~915 (RF)	70 (IF)	70 (IF)	935~960 (RF)
LO Frequency Range (MHz)	820~845	820~845	1005~1030	1005~1030
Conversion Gain (dB)	8.0±1	9.0±1	9.0±1	9.0±1
Gain Flatness (Max.) (dB)	±0.5	±0.5	±0.5	±0.5
Noise Figure (Typ.)(dB)	8.0±0.5	6.5±0.5	6.5±0.5	6.5±0.5
OIP3 (Typ. dBm)	26	28	28	26
LO to RF Leakage (dBm)	-6	-15	-15	-6
LO to IF Leakage (dBm)	-15	-15	-15	-15
RF(IF) to IF(RF) Leakage(dBm)	35	35	35	35
LO Output Level (dBm)	4±1	4±1	4±1	4±1
LO Phase Noise (Typ.) Step Size : 10KHz	-65dBc/Hz @1KHz -95dBc/Hz @10KHz -115dBc/Hz @100KHz	-65dBc/Hz @1KHz -95dBc/Hz @10KHz -115dBc/Hz @100KHz	-65dBc/Hz @1KHz -95dBc/Hz @10KHz -115dBc/Hz @100KHz	-65dBc/Hz @1KHz -95dBc/Hz @10KHz -115dBc/Hz @100KHz
PLL Control (LMX2326)	3 wire	3 wire	3 wire	3 wire
Vcc/Idd	5V / 170mA	5V / 170mA	5V / 170mA	5V / 170mA

Functional Diagram

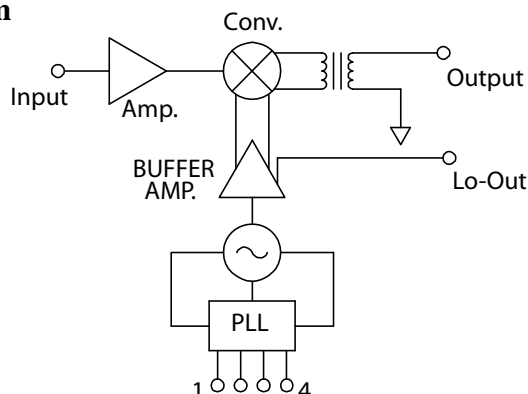

RFUR09-50, 56 OIP3 Test (Up Converter)

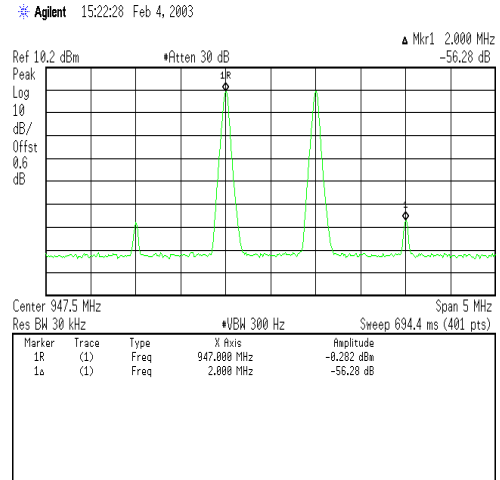
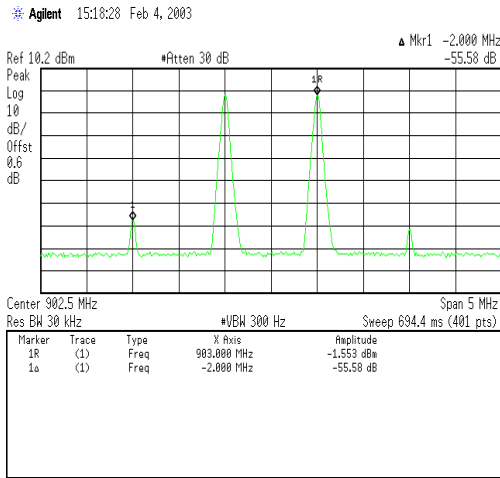

RFDR09-51, 55 OIP3 Test (Down Converter)

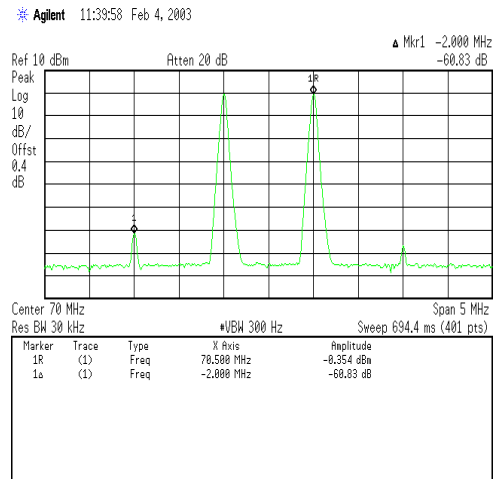
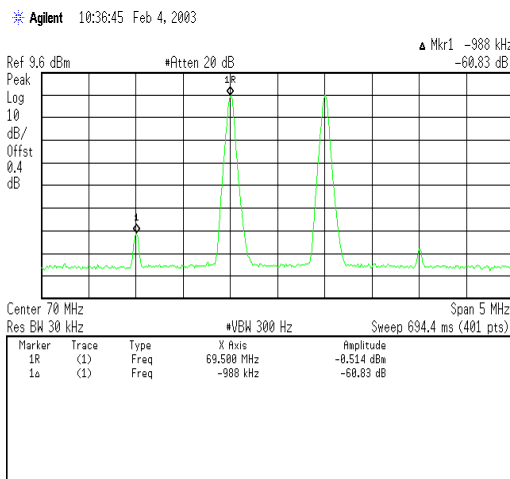

RFDR09-51, 55 Noise Figure Test (Down Converter)

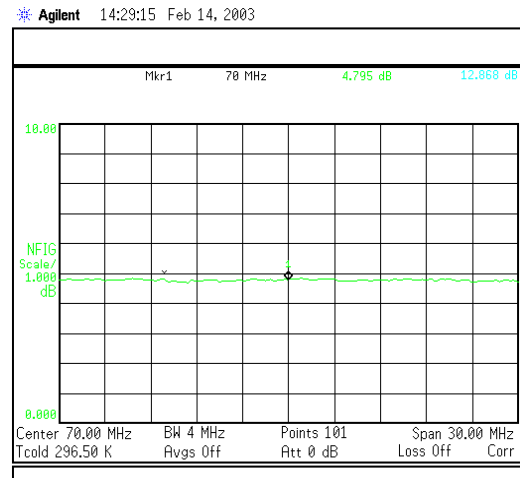
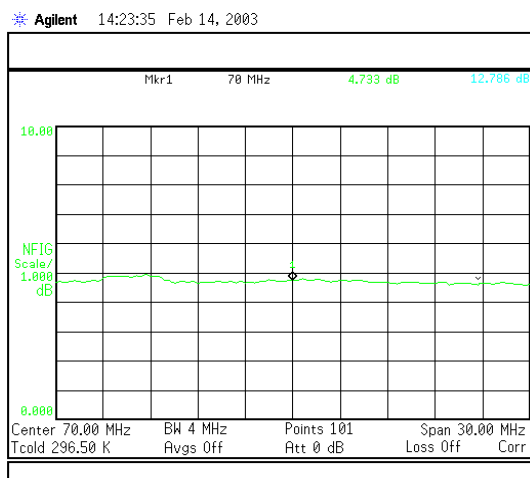

Pacakage Dimensions (Type: HY-5A)

Unit : $\frac{\text{mm}}{\text{[inch]}}$	Tolerance : $\pm \frac{0.2}{.008}$
--	------------------------------------

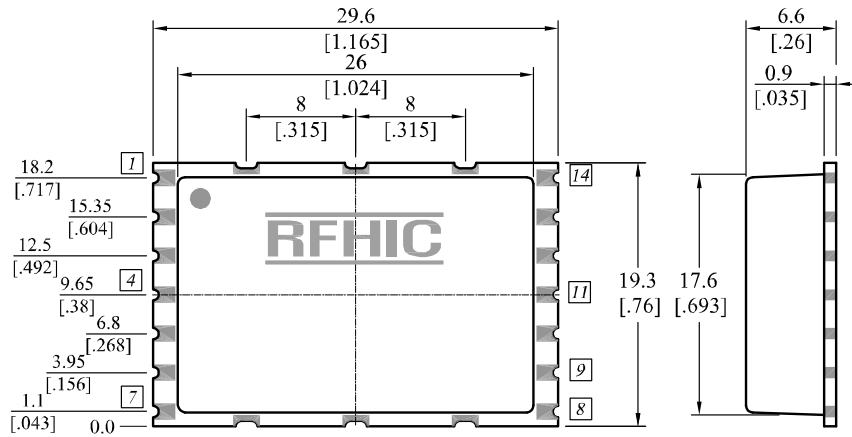

Recommended Pattern

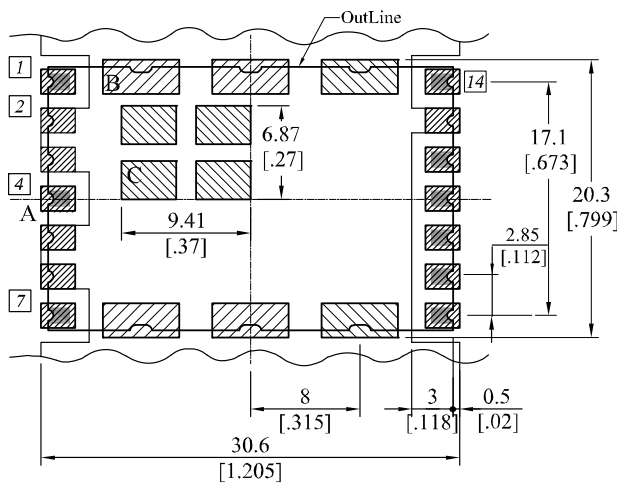

Pin No.	Function	Pin No.	Function
1	Input	14	Output
2	Ground	13	Ground
3	Ground	12	Lo_Out
4	Vcc+5V	11	Fo/LD
5	Ground	10	LE
6	Ground	9	Data
7	Ref in	8	Clock

Pattern Size WxL		
	mm	inch
A	2.5 x 1.8	.098 x .071
B	5.6 x 2.5	.22 x .098
C	4 x 2.8	.157 x .11

RFHIC Corporation (RFHIC) reserves the right to make changes to any products herein or to discontinue any product at any time without notice. RFHIC do not assume any liability for the suitability of its products for any particular purpose, and disclaims any and all liability, including without limitation consequential or incidental damages. The product specifications herein expressed have been carefully checked and are assumed to be reliable. However, RFHIC disclaims liability for inaccuracies and strongly recommends buyers to verify that the information they are using is current before placing purchase orders. RFHIC products are not intended for use in life support equipment or application where malfunction of the product can be expected to result in personal injury or death. Buyer uses or sells such products for any such unintended or unauthorized application, buyer shall indemnify, protect and hold RFHIC and its directors, officers, stockholders, employees, representatives and distributors harmless against any and all claims arising out of such use. RFHIC's liability under or arising out of damages, claims of whatsoever kind and nature which RFHIC products could cause shall be limited in amount to the net purchase price of the products sold to buyer by RFHIC.