

Selected Packages\*  
**U.L. RECOGNIZED**  
File #E71639

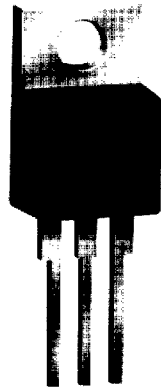

TO-202AB



THERMOTAB  
TO-220AB



TO-92



A SIEBE COMPANY  
1801 HURD DRIVE  
IRVING, TEXAS 75038-4385  
PHONE 214/580-1515  
FAX 214/550-1309

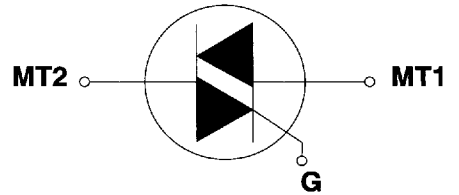

# TRIACS

(1- 25 AMPS)

## GENERAL DESCRIPTION

These gated triacs from Teccor Electronics are part of a broad line of bidirectional semiconductors. The devices range in current ratings from 1 to 25 amperes and in voltages from 200 to 800 volts.

The triac may be gate triggered from a blocking to conduction state for either polarity of applied voltage and is designed for AC switching and phase control applications such as speed and temperature modulation controls, lighting controls and static switching relays. The triggering signal is normally applied between the gate and MT1.

Teccor's gated triacs are available in a choice of different packages as shown above. Most packages are offered in the electrically-isolated construction where the case or tab is electrically-isolated from the semiconductor chip. This feature facilitates the use of low-cost assembly and convenient packaging techniques. Tape-and-reel capability is available. Please consult factory for more information.

All Teccor triacs have glass-passivated junctions to ensure long term device reliability and parameter stability. Teccor's glass offers a rugged, reliable barrier against junction contamination.

Variations of devices covered in this data sheet are available for custom design applications. Please consult factory for more information.

## Features

- Electrically-isolated packages
- Glass-passivated junctions
- Voltage capability — up to 800 volts
- Surge capability — up to 230 amps

# Electrical Specifications

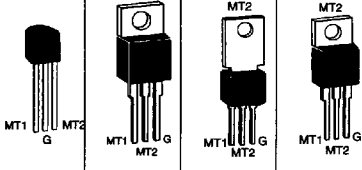
I <sub>T(RMS)</sub>	Part Number				V <sub>DRM</sub>	I <sub>GT</sub>					I <sub>BRM</sub>			V <sub>TM</sub>	V <sub>GT</sub>		
	Isolated		Non-Isolated			DC Gate Trigger Current in Specific Operating Quadrants V <sub>D</sub> = 12VDC R <sub>L</sub> = 60Ω (3) (7) mAmps					Peak Off-State Current Gate Open V <sub>DRM</sub> = Max Rated Value (1) (18) mAmps				Peak On-State Voltage at Max Rated RMS Current T <sub>C</sub> = 25°C (1) (5) Volts		
					Repetitive Peak Blocking Voltage (1) Volts	QI	QII	QIII	QIV	QV	T <sub>C</sub> = 25°C	T <sub>C</sub> = 100°C	T <sub>C</sub> = 125°C	Volts	T <sub>C</sub> = 125°C	T <sub>C</sub> = 25°C	
MAX	For Package Dimensions & Variations, See Page 95.				MIN	MAX					TYP	MAX			MAX	MIN	MAX
<b>1.0 Amp</b>	Q201E3				200	10	10	10		25	.02	0.5	1.0	1.6	0.2	2.0	
	Q401E3				400	10	10	10		25	.02	0.5	1.0	1.6	0.2	2.0	
	Q501E3				500	10	10	10		25	.02	0.5	1.0	1.6	0.2	2.0	
	Q601E3				600	10	10	10		25	.02	0.5	1.0	1.6	0.2	2.0	
	Q201E4				200	25	25	25		50	.02	0.5	1.0	1.6	0.2	2.5	
	Q401E4				400	25	25	25		50	.02	0.5	1.0	1.6	0.2	2.5	
<b>4.0 Amps</b>	Q2004L3	Q2004F31			200	10	10	10		25	.05	0.5	2.0	1.6	0.2	2.0	
	Q4004L3	Q4004F31			400	10	10	10		25	.05	0.5	2.0	1.6	0.2	2.0	
	Q5004L3	Q5004F31			500	10	10	10		25	.05	0.5	2.0	1.6	0.2	2.0	
	Q6004L3	Q6004F31			600	10	10	10		25	.05	0.5	2.0	1.6	0.2	2.0	
	Q2004L4	Q2004F41			200	25	25	25		50	.05	0.5	2.0	1.6	0.2	2.5	
	Q4004L4	Q4004F41			400	25	25	25		50	.05	0.5	2.0	1.6	0.2	2.5	
	Q5004L4	Q5004F41			500	25	25	25		50	.05	0.5	2.0	1.6	0.2	2.5	
	Q6004L4	Q6004F41			600	25	25	25		50	.05	0.5	2.0	1.6	0.2	2.5	
	Q7004L4				700	25	25	25		50	.05	0.5	2.0	1.6	0.2	2.5	
Q8004L4				800	25	25	25		50	.05	0.5	2.0	1.6	0.2	2.5		
<b>6.0 Amps</b>	Q2006L4	Q2006F41	Q2006R4		200	25	25	25		50	.05	0.5	2.0	1.6	0.2	2.5	
	Q4006L4	Q4006F41	Q4006R4		400	25	25	25		50	.05	0.5	2.0	1.6	0.2	2.5	
	Q5006L4	Q5006F41	Q5006R4		500	25	25	25		50	.05	0.5	2.0	1.6	0.2	2.5	
	Q6006L5	Q6006F51	Q6006R5		600	50	50	50		75	.05	0.5	2.0	1.6	0.2	2.5	
	Q7006L5		Q7006R5		700	50	50	50		75	.05	0.5	2.0	1.6	0.2	2.5	
	Q8006L5		Q8006R5		800	50	50	50		75	.05	0.5	2.0	1.6	0.2	2.5	
<b>8.0 Amps</b>	Q2008L4	Q2008F41	Q2008R4		200	25	25	25		50	.05	0.5	2.0	1.6	0.2	2.5	
	Q4008L4	Q4008F41	Q4008R4		400	25	25	25		50	.05	0.5	2.0	1.6	0.2	2.5	
	Q5008L4	Q5008F41	Q5008R4		500	25	25	25		50	.05	0.5	2.0	1.6	0.2	2.5	
	Q6008L5	Q6008F51	Q6008R5		600	50	50	50		75	.05	0.5	2.0	1.6	0.2	2.5	
	Q7008L5		Q7008R5		700	50	50	50		75	.05	0.5	2.0	1.6	0.2	2.5	
	Q8008L5		Q8008R5		800	50	50	50		75	.05	0.5	2.0	1.6	0.2	2.5	

## GENERAL NOTES

- All measurements are made at 60 Hz with a resistive load at an ambient temperature of +25°C unless specified otherwise.
- Operating temperature range (T<sub>J</sub>) is -65°C to +125°C for TO-92, and -40°C to +125°C for all other devices
- Storage temperature range (T<sub>S</sub>) is -65°C to +150°C for TO-92, and -40°C to +150°C for TO-202 devices, and -40°C to +125°C for all other devices.
- Lead solder temperature is a maximum of 230°C for 10 seconds, maximum; ≥ 1/16" (1.59mm) from case
- The case temperature (T<sub>C</sub>) is measured as shown on the dimensional outline drawings. See "Package Dimensions" section of this catalog on Page 95.

# Triacs

I <sub>H</sub>	I <sub>GT</sub>	P <sub>GM</sub>	P <sub>G(AV)</sub>	I <sub>RSM</sub>		dv/dt (c)	dv/dt		t <sub>gt</sub>	I <sub>t</sub>	di/dt
				Amps			Volts/μSec				
MAX				60Hz	50Hz	TYP	MIN		TYP		
15	1.0	10	0.2	20	16.7	1.0	40	30	2.5	1.6	30
15	1.0	10	0.2	20	16.7	1.0	40	30	2.5	1.6	30
15	1.0	10	0.2	20	16.7	1.0	30	20	2.5	1.6	30
15	1.0	10	0.2	20	16.7	1.0	30	20	2.5	1.6	30
25	1.0	10	0.2	20	16.7	1.0	50	40	3	1.6	30
25	1.0	10	0.2	20	16.7	1.0	50	40	3	1.6	30
25	1.0	10	0.2	20	16.7	1.0	40	30	3	1.6	30
25	1.0	10	0.2	20	16.7	1.0	40	30	3	1.6	30
20	1.2	15	0.3	55	46	2.0	50	40	2.5	12.5	50
20	1.2	15	0.3	55	46	2.0	50	40	2.5	12.5	50
20	1.2	15	0.3	55	46	2.0	40	30	2.5	12.5	50
20	1.2	15	0.3	55	46	2.0	40	30	2.5	12.5	50
30	1.2	15	0.3	55	46	2.0	100	75	3	12.5	50
30	1.2	15	0.3	55	46	2.0	100	75	3	12.5	50
30	1.2	15	0.3	55	46	2.0	75	50	3	12.5	50
30	1.2	15	0.3	55	46	2.0	75	50	3	12.5	50
30	1.2	15	0.3	55	46	2.0	60	40	3	12.5	50
30	1.2	15	0.3	55	46	2.0	60	40	3	12.5	50
50	1.6	18	0.5	80	65	4.0	200	120	3	26.5	70
50	1.6	18	0.5	80	65	4.0	200	120	3	26.5	70
50	1.6	18	0.5	80	65	4.0	150	100	3	26.5	70
50	1.6	18	0.5	80	65	4.0	150	100	3	26.5	70
50	1.6	18	0.5	80	65	4.0	125	85	3	26.5	70
50	1.6	18	0.5	80	65	4.0	125	85	3	26.5	70
50	1.8	20	0.5	100	83	4.0	250	150	3	41	70
50	1.8	20	0.5	100	83	4.0	250	150	3	41	70
50	1.8	20	0.5	100	83	4.0	220	125	3	41	70
50	1.8	20	0.5	100	83	4.0	220	125	3	41	70
50	1.8	20	0.5	100	83	4.0	150	100	3	41	70
50	1.8	20	0.5	100	83	4.0	150	100	3	41	70

## NOTES TO ELECTRICAL SPECIFICATIONS

- For either polarity of MT2 with reference to MT1 terminal.
- For either polarity of gate voltage (V<sub>GT</sub>) with reference to MT1 terminal.
- See Definition of quadrants.
- See Figures 1A, B, C, D, E, F and Figure 2 for current rating at specific operating temperature.
- See Figures 3A, B and C for I<sub>T</sub> vs V<sub>T</sub>.
- See Figure 5 for V<sub>GT</sub> vs T<sub>C</sub>.
- See Figure 4 for I<sub>GT</sub> vs T<sub>C</sub>.
- See Figure 6 for I<sub>H</sub> vs T<sub>C</sub>.
- See Figure 7 for surge rating with specific durations.
- See Figures 8A and 8B for t<sub>gt</sub> vs I<sub>GT</sub>.
- See package outlines for lead form configurations. When ordering special lead forming, add type number as suffix to part number.
- Initial on-state current = 200mA(DC) for 1-10 amp devices, 400 mA(DC) for 15 amp to 25 amp devices.
- See Figure 1(A,B,C,D,E and F) for maximum allowable case temperature at maximum rated current.
- Pulse width ≤ 10μs.
- R<sub>L</sub> = 60Ω for 1-10 amp triacs; R<sub>L</sub> = 30Ω for 15-25 amp triacs.
- T<sub>C</sub> = T<sub>J</sub> for test conditions in off-state.
- I<sub>GT</sub> = 500 mA for 25 amp devices.
- Quadrants I, II, and III only.

# Electrical Specifications

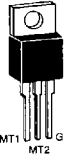
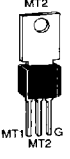
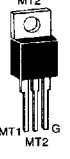
$I_T(RMS)$	Part Number			$V_{DRM}$	$I_{GT}$					$I_{DRM}$			$V_{GT}$	
	Isolated	Non-Isolated			mAmps					mAmps			Volts	
RMS On-State Current Conduction Angle of 360° (4) (16)				Repetitive Peak Blocking Voltage (1)	DC Gate Trigger Current In Specific Operating Quadrants $V_D = 12VDC$ (3) (7) (15)					Peak Off-State Current Gate Open $V_{DRM} = \text{Max Rated Value}$ (1) (16)			DC Gate Trigger Voltage $V_D = 12VDC$ (2) (6) (15) (18)	
	THERMOTAB TO-220AB	TO-202AB	TO-220AB	Volts	QI	QII	QIII	QIV	QIV	$T_C = 25^\circ C$	$T_C = 100^\circ C$	$T_C = 125^\circ C$	$T_C = 125^\circ C$	$T_C = 25^\circ C$
MAX	For Package Dimensions & Variations, See Page 95.			MIN	MAX				TYP	MAX			MIN	MAX
10.0 Amps	Q2010L5	Q2010F51	Q2010R5	200	50	50	50	75	.05	0.5	2.0	0.2	2.5	
	Q4010L5	Q4010F51	Q4010R5	400	50	50	50	75	.05	0.5	2.0	0.2	2.5	
	Q5010L5	Q5010F51	Q5010R5	500	50	50	50	75	.05	0.5	2.0	0.2	2.5	
	Q6010L5	Q6010F51	Q6010R5	600	50	50	50	75	.05	0.5	2.0	0.2	2.5	
	Q7010L5		Q7010R5	700	50	50	50	75	.05	0.5	2.0	0.2	2.5	
15.0 Amps	Q8010L5		Q8010R5	800	50	50	50	75	0.1	0.5	2.0	0.2	2.5	
	Q2015L5		Q2015R5	200	50	50	50		.05	0.5	2.0	0.2	2.5	
	Q4015L5		Q4015R5	400	50	50	50		.05	0.5	2.0	0.2	2.5	
	Q5015L5		Q5015R5	500	50	50	50		.05	0.5	2.0	0.2	2.5	
	Q6015L5		Q6015R5	600	50	50	50		.05	0.5	2.0	0.2	2.5	
25.0 Amps	Q7015L5		Q7015R5	700	50	50	50		0.1	1.0	3.0	0.2	2.5	
	Q8015L5		Q8015R5	800	50	50	50		0.1	1.0	3.0	0.2	2.5	
			Q2025R5	200	50	50	50		0.1	1.0	3.0	0.2	2.5	
			Q4025R5	400	50	50	50		0.1	1.0	3.0	0.2	2.5	
			Q5025R5	500	50	50	50		0.1	1.0	3.0	0.2	2.5	
			Q6025R5	600	50	50	50		0.1	1.0	3.0	0.2	2.5	
		Q7025R5	700	50	50	50		0.1	1.0	3.0	0.2	2.5		
		Q8025R5	800	50	50	50		0.1	1.0	3.0	0.2	2.5		

## GENERAL NOTES

- All measurements are made at 60 Hz with a resistive load at an ambient temperature of +25°C unless specified otherwise.
- Operating temperature range ( $T_J$ ) is -65°C to +125°C for TO-92, and -40°C to +125°C for all other devices
- Storage temperature range ( $T_S$ ) is -65°C to +150°C for TO-92, and -40°C to +150°C for TO-202 devices, and -40°C to +125°C for all other devices.
- Lead solder temperature is a maximum of 230°C for 10 seconds, maximum;  $\geq 1/16"$  (1.59mm) from case
- The case temperature ( $T_C$ ) is measured as shown on the dimensional outline drawings. See "Package Dimensions" section of this catalog on Page 95.

# Triacs





V <sub>TM</sub>	I <sub>H</sub>	I <sub>GT</sub>	P <sub>GM</sub>	P <sub>G(AV)</sub>	I <sub>TSM</sub>		dv/dt(c)	dv/dt		t <sub>gt</sub>	I <sup>2</sup> t	di/dt
					60Hz	50Hz		Volts/μSec				
Peak On-State Voltage at Maximum Rated RMS Current T <sub>C</sub> = 25°C (1) (5)	Holding Current (DC) Gate Open (1) (8) (12)	Peak Gate Trigger Current (14)	Peak Gate Power Dissipation (14)	Average Gate Power Dissipation	Peak One-Cycle Surge (9) (13)		Critical Rate-of-Rise of Commutation Voltage at Rated V <sub>DRM</sub> & I <sub>T</sub> (RMS) Commutating di/dt = 0.54 Rated I <sub>T</sub> (RMS)/ms Gate Unenergized (1) (4) (13)	Critical Rate-of-Rise of Off-State Voltage at Rated V <sub>DRM</sub> Gate Open (1)		Gate Controlled Turn-On Time I <sub>GT</sub> = 200mA 0.1μs Rise Time (10) (17)	RMS Surge (Non-Repetitive) On-State Current for Period of 8.3ms For Fusing	Maximum Rate-of-Change of On-State Current I <sub>GT</sub> = 200mA with 0.1μs Rise Time
Volts	Amps	Amps	Watts	Watts	Amps			Volts/μSec				
MAX	MAX						TYP	MIN		TYP		
1.6	50	1.8	20	0.5	120	100	4	350	225	3	60	70
1.6	50	1.8	20	0.5	120	100	4	350	225	3	60	70
1.6	50	1.8	20	0.5	120	100	4	300	200	3	60	70
1.6	50	1.8	20	0.5	120	100	4	300	200	3	60	70
1.6	50	1.8	20	0.5	120	100	4	250	175	3	60	70
1.6	50	1.8	20	0.5	120	100	4	250	175	3	60	70
1.6	70	2.0	20	0.5	200	167	4	400	275	4	166	100
1.6	70	2.0	20	0.5	200	167	4	400	275	4	166	100
1.6	70	2.0	20	0.5	200	167	4	350	225	4	166	100
1.6	70	2.0	20	0.5	200	167	4	350	225	4	166	100
1.6	70	2.0	20	0.5	200	167	4	300	200	4	166	100
1.6	70	2.0	20	0.5	200	167	4	300	200	4	166	100
1.8	100	2.0	20	0.5	230	200	5	400	275	4	220	100
1.8	100	2.0	20	0.5	230	200	5	400	275	4	220	100
1.8	100	2.0	20	0.5	230	200	5	350	225	4	220	100
1.8	100	2.0	20	0.5	230	200	5	350	225	4	220	100
1.8	100	2.0	20	0.5	230	200	5	300	200	4	220	100
1.8	100	2.0	20	0.5	230	200	5	300	200	4	220	100

## NOTES TO ELECTRICAL SPECIFICATIONS

- For either polarity of MT2 with reference to MT1 terminal.
- For either polarity of gate voltage (V<sub>GT</sub>) with reference to MT1 terminal.
- See Definition of quadrants.
- See Figures 1A, B, C, D, E, F and Figure 2 for current rating at specific operating temperature.
- See Figures 3A, B and C for I<sub>T</sub> vs V<sub>T</sub>.
- See Figure 5 for V<sub>GT</sub> vs T<sub>C</sub>.
- See Figure 4 for I<sub>GT</sub> vs T<sub>C</sub>.
- See Figure 6 for I<sub>H</sub> vs T<sub>C</sub>.
- See Figure 7 for surge rating with specific durations.
- See Figures 8A and 8B for t<sub>gt</sub> vs I<sub>GT</sub>.
- See package outlines for lead form configurations. When ordering special lead forming, add type number as suffix to part number.
- Initial on-state current = 200mA(DC) for 1-10 amp devices, 400 mA(DC) for 15 amp to 25 amp devices.
- See Figure 1(A,B,C,D,E and F) for maximum allowable case temperature at maximum rated current.
- Pulse width ≤ 10μs.
- R<sub>L</sub> = 60Ω for 1-10 amp triacs; R<sub>L</sub> = 30Ω for 15-25 amp triacs.
- T<sub>C</sub> = T<sub>J</sub> for test conditions in off-state.
- I<sub>GT</sub> = 500 mA for 25 amp devices.
- Quadrants I, II, and III only.

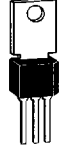
# Electrical Specifications

## THERMAL RESISTANCE (STEADY STATE) $R_{\theta JC}$ [ $R_{\theta JA}$ ] (TYP.) °C/W

Type					
	TO-92	TYPE 1 TO-202AB	TYPE 2 TO-202AB	THERMOTAB TO-220AB	NON-ISOLATED TO-220AB
1.0 amp	50 [95]				
4.0 amps		3.5 [45]	6 [70]	3.6 [50]	
6.0 amps		3.8		3.3	2.1 [45]
8.0 amps		3.3		2.8	1.8
10.0 amps		3.5		2.6	1.5
15.0 amps				2.1	1.3
25.0 amps				2.0	1.1

## ELECTRICAL ISOLATION FROM LEADS TO MOUNTING TAB

TYPE	TO-92	Isolated ** TO-220AB
VAC (RMS)		
1600	Standard	—
2500	N/A	Standard
4000	N/A	Optional *

\* For 4000V isolation, use V suffix in part number.

\*\* UL Recognized File E71639

## GATE CHARACTERISTICS

Teccor triacs may be gated with in-phase signals (using standard AC line) in which Quadrants I & III are used, or by applying unipolar pulses (gate always positive or negative), where if a negative pulse is applied, Quadrants II & III are used, and Quadrants I & IV are used when a positive pulse is applied. However, due to higher gate requirements for Quadrant IV, it is recommended that only negative pulses be applied. If positive pulses are required, see logic triac sections of catalog or contact factory. In all cases, if maximum surge capability is required, pulses should be a minimum of one magnitude above minimum  $I_{GT}$  rating with a steep rising waveform (1  $\mu$ sec rise time).

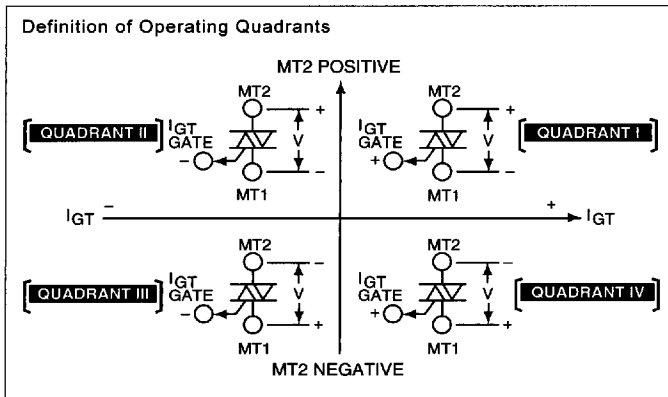

## ELECTRICAL ISOLATION

Most Teccor isolated triac packages will withstand a minimum high potential test of 2500VAC (RMS) from leads to mounting tab, over the operating temperature range of the device. See isolation table for standard and optional isolation ratings.

Figure 2 — Maximum Allowable Ambient Temperature vs On-State Current

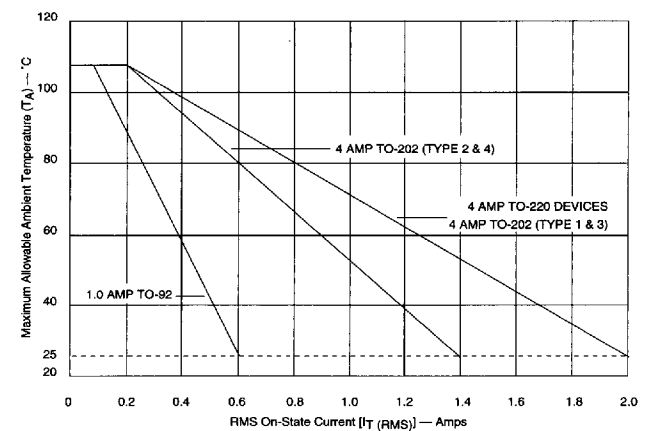

Figure 1A — Maximum Allowable Case Temperature vs On-State Current

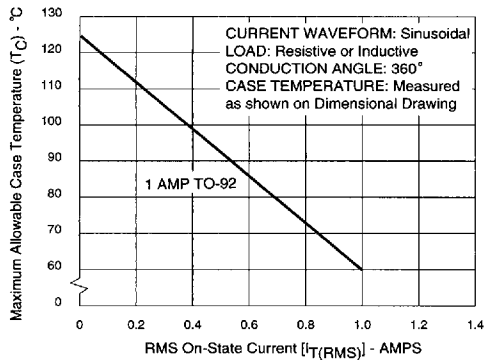

Figure 1B — Maximum Allowable Case Temperature vs On-State Current

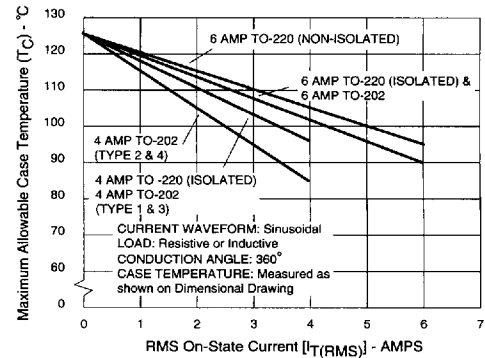

Figure 1C — Maximum Allowable Case Temperature vs On-State Current

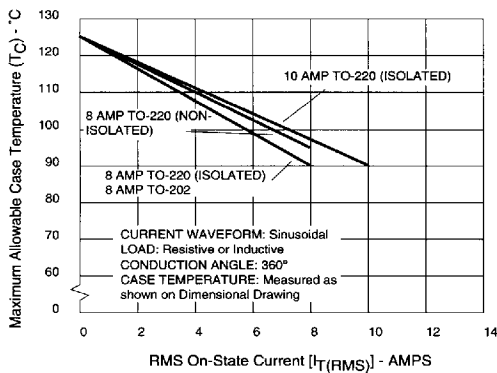

Figure 1D — Maximum Allowable Case Temperature vs On-State Current

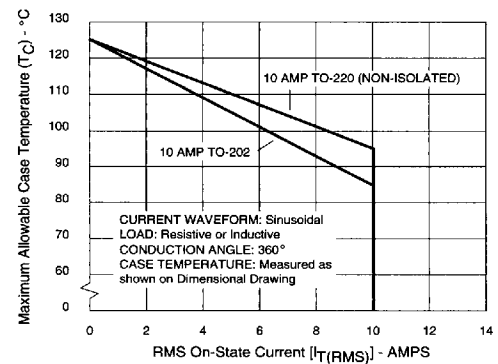

Figure 1E — Maximum Allowable Case Temperature vs On-State Current

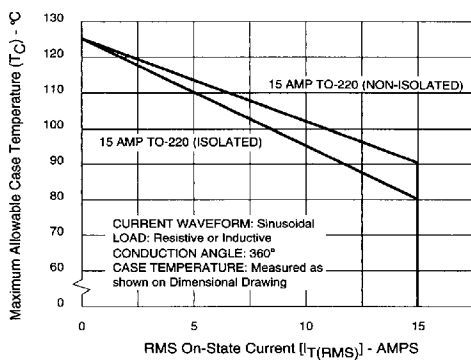
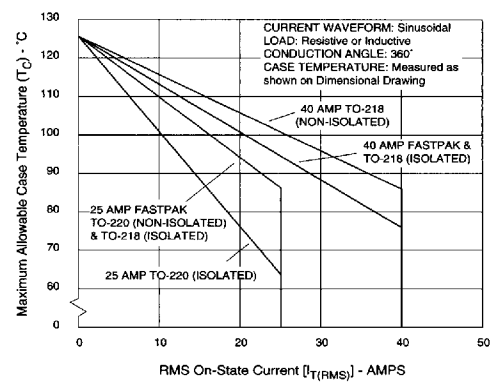

Figure 1F — Maximum Allowable Case Temperature vs On-State Current



# Electrical Specifications

Figure 3A — On-State Current vs On-State Voltage (Typical)

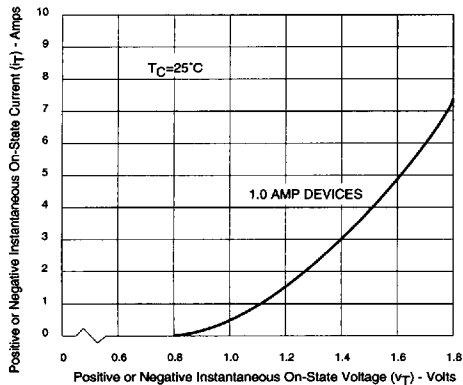

Figure 3B — On-State Current vs On-State Voltage (Typical)

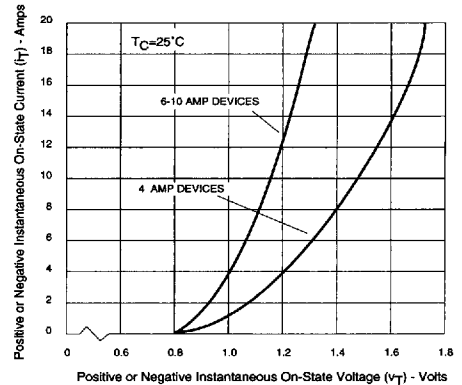

Figure 3C — On-State Current vs On-State Voltage (Typical)

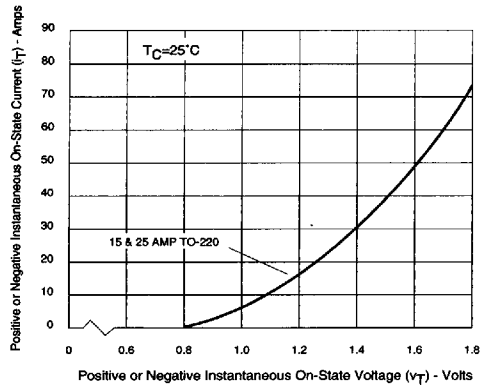

Figure 4 — Normalized DC Gate Trigger Current for All Quadrants vs Case Temperature

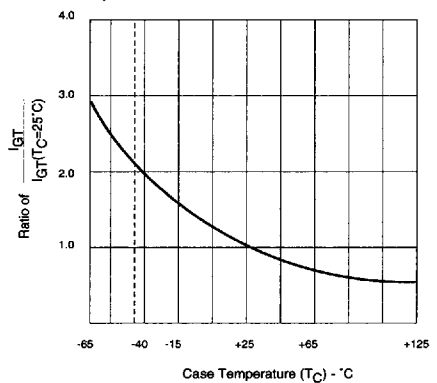

Figure 5 — Normalized DC Gate Trigger Voltage for All Quadrants vs Case Temperature

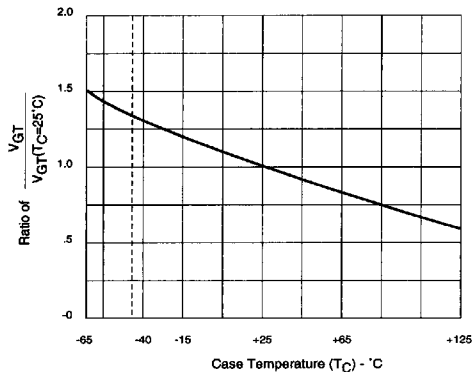

Figure 6 — Normalized DC Holding Current vs Case Temperature

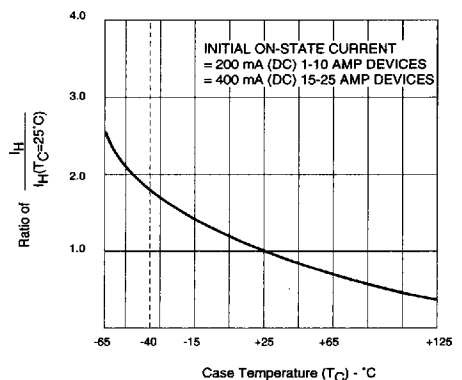
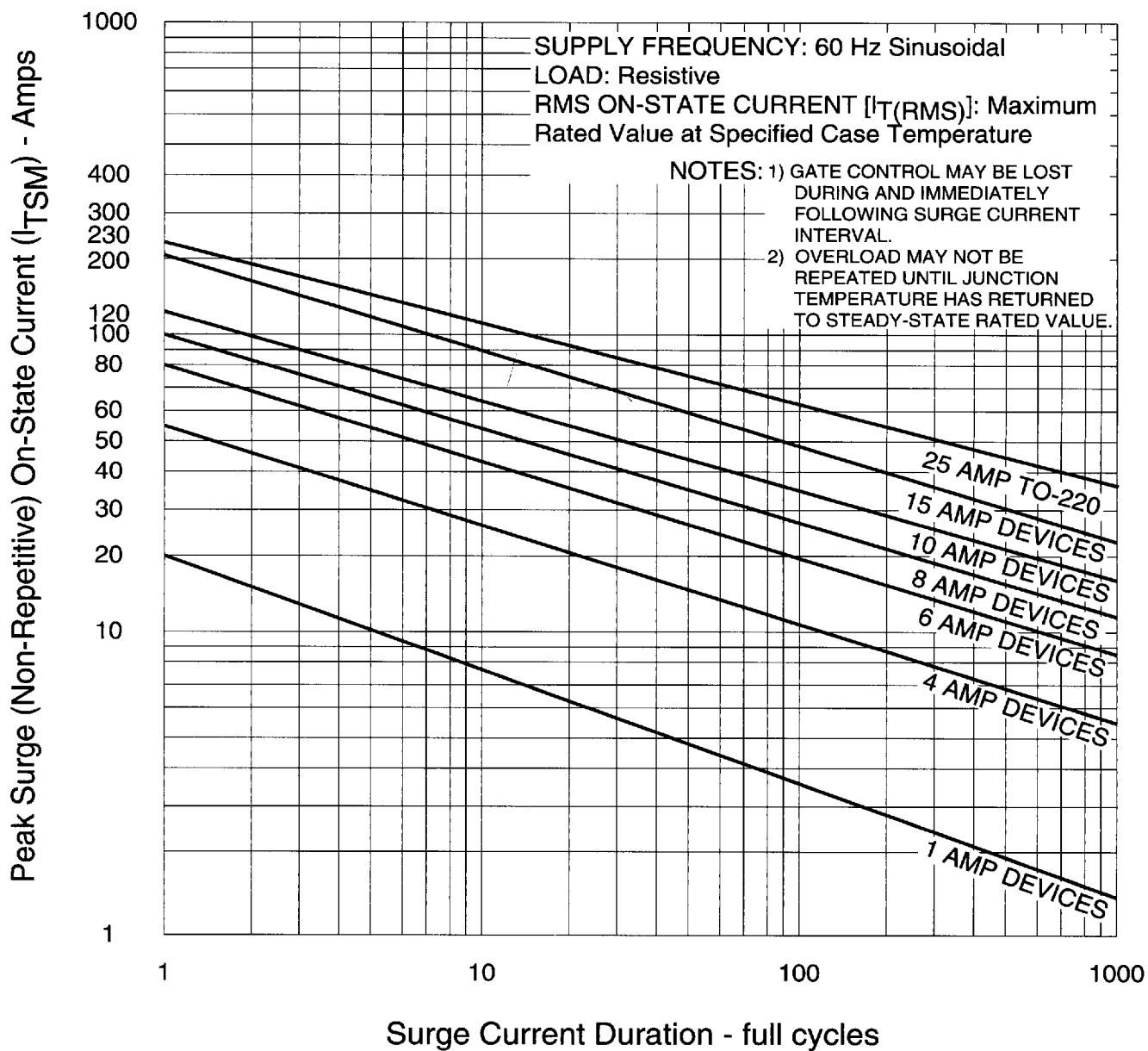



Figure 7 — Peak Surge Current vs Surge Current Duration



# Electrical Specifications

Figure 8A — Turn-On Time vs Gate Trigger Current (Typical)

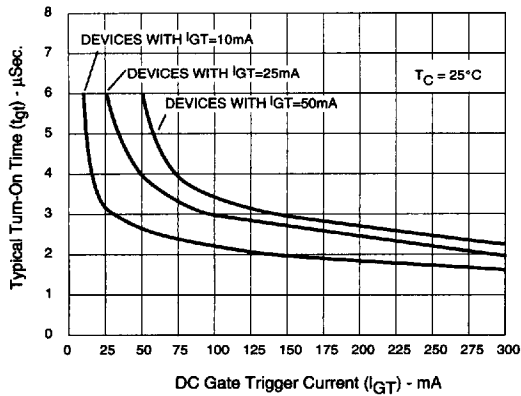

Figure 8B — Turn-On Time vs Gate Trigger Current (Typical)

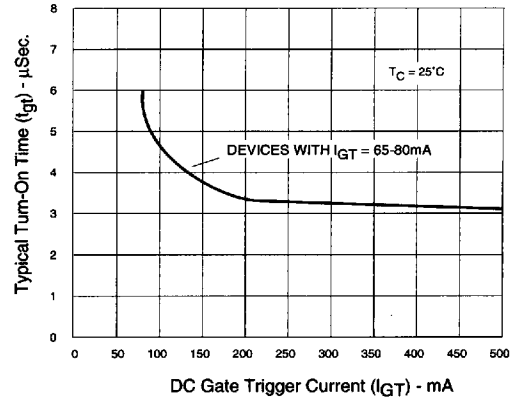

Figure 9A — Power Dissipation (Typical) vs On-State Current

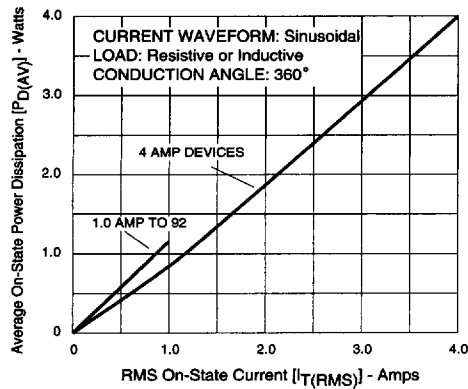

Figure 9B — Power Dissipation (Typical) vs On-State Current

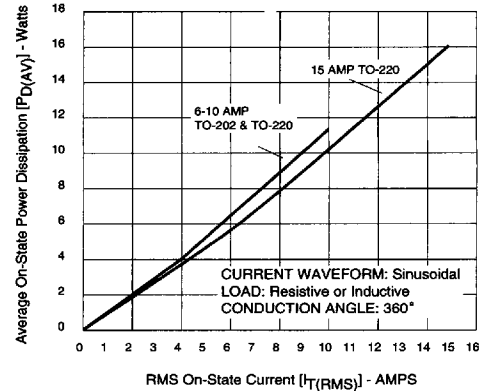

Figure 9C — Power Dissipation (Typical) vs On-State Current

