

Flat panel sensor C7942CA-02, C7943CA-02

Acquire digital X-ray image in real time and 170 & 176 mm diagonal size

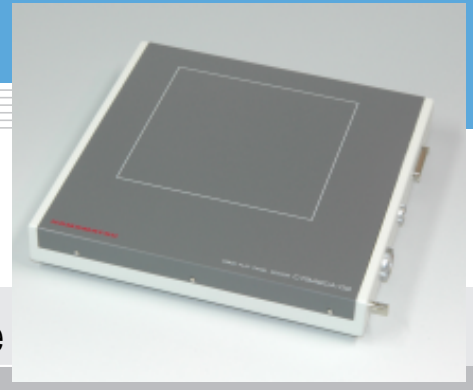

Flat panel sensors C7942CA-02 and C7943CA-02 are digital X-ray image sensors newly developed as key devices for non-destructive inspection, biochemical imaging, X-ray microscopy and other real-time X-ray imaging applications requiring high resolution and high image quality.

Features

- C7942CA-02: 2400 × 2400 pixels
C7943CA-02: 1248 × 1248 pixels
- Digital output (12-bit)
- High-speed imaging:
C7942CA-02: 2 frames/s (single operation)
9 frames/s (4 × 4 binning)
C7943CA-02: 7 frames/s (single operation)
30 frames/s (4 × 4 binning)
- Low noise and wide dynamic range
- Compact package
- Easy use

Applications

- Non-destructive inspection
- Digital X-ray photography

■ Block diagram (C7942CA-02)

C7942CA-02 is a lightweight and compact flat panel sensor consisting of a sensor board and a control board. The sensor board also has 8 charge-sensitive amplifier arrays each having 300 ch amplifiers with a horizontal shift register. Analog video signals are amplified as the charge on each video line by 2400 ch charge amplifiers with CDS (Correlated Double Sampling) circuits added, and are output each of 8 amplifier arrays. The control board converts the analog video signal into a 12-bit digital signal and outputs it to an external frame grabber through the 12-bit parallel port.

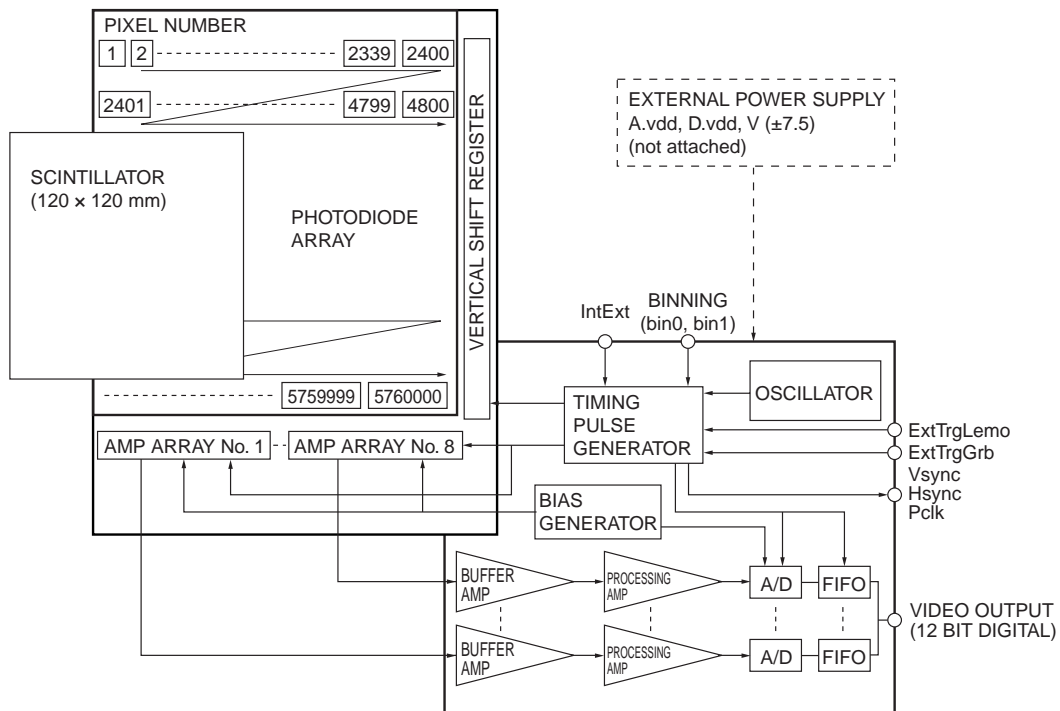

Note: Signals are read out in order of pixel number.

KACCC0216EB

Flat panel sensor C7942CA-02, C7943CA-02

General ratings

Parameter	C7942CA-02	C7943CA-02	Unit
Pixel size	50 × 50	100 × 100	μm
Photodiode area	120 × 120	124.8 × 124.8	mm
Number of pixels	2400 × 2400	1248 × 1248	pixels
Number of active pixels	2240 × 2344	1216 × 1220	pixels
Readout	Charge amplifier array		-
Video output (Data1 - 12)	RS-422 (differential) 12 bit		-
Output data rate	15.15		MHz
Synchronous signal (Vsync, Hsync, Pclk)	RS-422 (differential)		-
bin0/1, ExtTrgGrb, ExtTrgLemo, IntExt	TTL		-
Scintillator	Csl		-

Absolute maximum ratings (Ta=25 °C)

Parameter	Symbol	Value	Unit
Supply voltage for digital circuitry (+5 V)	D.vdd	+6.0	V
Supply voltage for analog circuitry (+5 V)	A.vdd	+6.0	V
Supply voltage for analog circuitry (±7.5 V)	V(±7.5)	±12	V
Input voltage (bin0/1, ExtTrgGrb, ExtTrgLemo, IntExt)	Vin	0 to 6.0	V
Operating temperature *1	Topr	0 to +35	°C
Storage temperature *1	Tstg	0 to +50	°C

*1: No condensation

Specification [Ta=25 °C, A.vdd= 5.0 V, D.vdd= 5.0 V, V (±7.5)= ±7.5 V]

Parameter	Symbol	C7942CA-02			C7943CA-02			Unit
		Min.	Typ.	Max.	Min.	Typ.	Max.	
Frame rate (single operation)	Sf (int)	1.9	2	-	6.65	7	-	frames/s
Frame rate (2 × 2 binning)		-	4	-	-	15	-	frames/s
Frame rate (4 × 4 binning)		-	9	-	-	30	-	frames/s
Frame rate external (single operation)	Sf (ext)	-	Sf (int) to 0.1	-	-	Sf (int) to 0.1	-	frames/s
Noise (rms) *2	N (rms)	-	1100	-	-	2300	-	electrons
Saturation charge	Csat	-	2.2	-	-	10	-	M electrons
Sensitivity *3	S	20	25	-	22.4	28	-	LSB/mR
Resolution *4	Reso	6	8	-	4	5	-	line pairs/mm
Dynamic range		-	2000	-	-	4300	-	-
Defect line *5	-	-	-	20	-	-	10	lines
Output offset *6	-	-	65	200	-	65	200	LSB

*2: Internal trigger mode, single operation

*3: at 80 kVp without filter

*4: Spatial frequency at CTF=5 %

*5: A defect line is a horizontal or vertical line containing 4 or more pixels that produce less than 1/8 of the average output from surrounding pixels and are formed continuously from the opposite side of an amplifier array or a vertical shift register. Without a couple of adjacent defect line.

*6: Average of all effective pixels in single operation at Sf (int)

Note: X-ray energy range is 20 k to 100 kVp.

Resolution

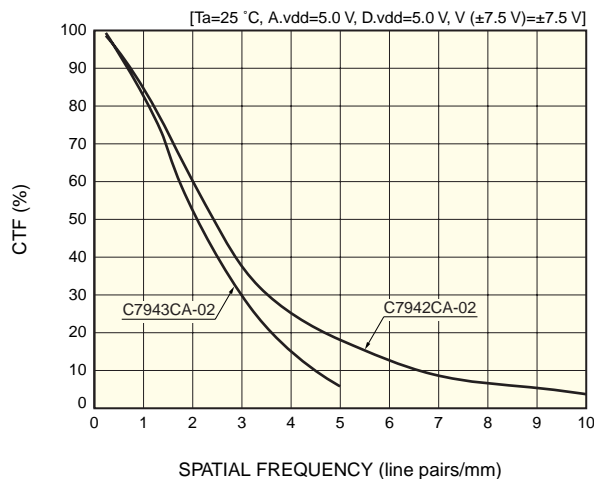

■ Timing chart

To acquire images through an image grabber board, write parameters in the software program or parameter file by referring to the following timing chart and description.

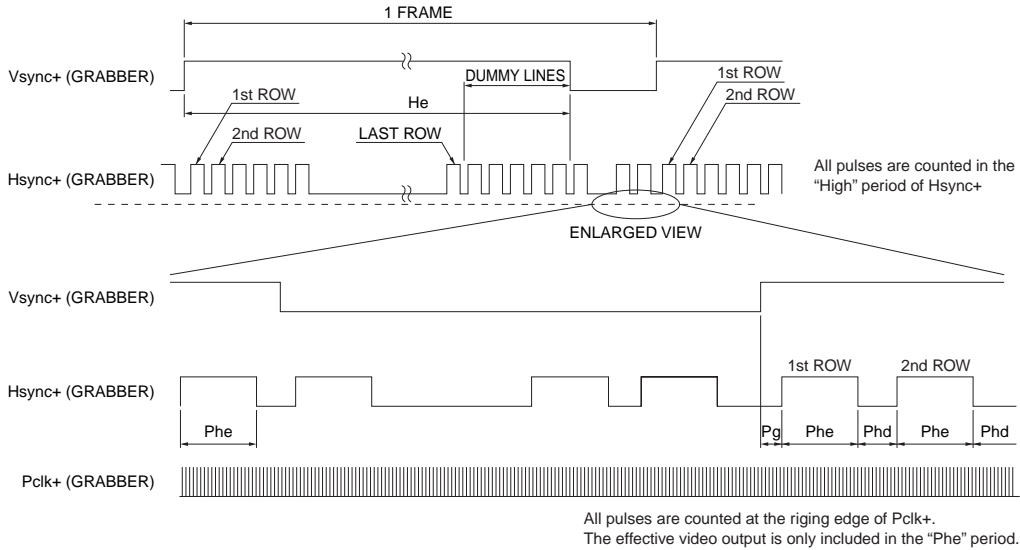

KACCC0362EA

Parameter		Pulse					
		C7942CA-02			C7943CA-02		
		1 × 1	2 × 2	4 × 4	1 × 1	2 × 2	4 × 4
He	Effective line	2344	1172	586	1220	610	305
	Dummy line	56	28	14	28	14	7
Phe	Effective pixel	2240	1120	560	1216	608	304
	Dummy pixel	160	80	40	32	16	8
Phd		526	1726	2326	334	958	1270
Pg		21	21	21	27	27	27

Note: "He" is the Hsync count. Phe, Phd and Pg are the Pclk count.

■ External trigger mode

To acquire images in external trigger mode, input an external trigger pulse as shown below. When the time Tvd has passed after the rising edge of the external trigger pulse, synchronous signals and video signals are output.

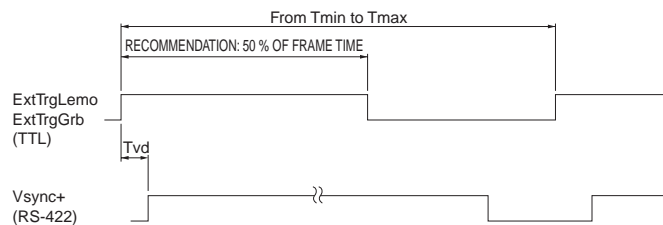

- Hsync+, Pclk+ and Data 1-12 are the same as internal trigger mode.
- Tmin is defined as 1/Sf (int).
 - Tmax is defined as the reciprocal of the minimum value of Sf (ext).
 - Tvd=390 μs (C7942CA-02)
210 μs (C7943CA-02)

KACCC0369EA

■ System requirements

To operate C7942CA-02 and C7943CA-02 Flat Panel Sensors at full performance, the following system and peripherals are required.

- PC: IBM compatible PC running on Windows XP
- Digital frame grabber card: Monochrome 16 bits or more, pixel clock 16 MHz or more, RS-422 interface synchronous signal (See the frame grabber manual.)

The National Instruments IMAQ PCI-1424 (NI parts No. 777662-01) frame grabber with optional memory 64 MB (NI parts No. 920130-64) has been verified to successfully acquire 12-bit digital images from both C7942CA-02 and C7943CA-02. The IMAQ PCI-1422 (NI parts No. 777959-01) also acquires satisfactory images from C7943CA-02. You can utilize the demonstration software that comes with the frame grabber as a simple viewer, to acquire and save an image. To do so, refer to the frame grabber user's guide for how to use the camera information file for the demonstration software.

- Power source: A.vdd = +5.0 ± 0.1 V (700 mA), D.vdd = +5.0 ± 0.1 V (1000 mA), V (±7.5) = ±7.5 ± 0.5 V (±100 mA)

Please use of a series power supply. (Avoid using a switching power supply.) A power cable (terminated with an FGG.2B.307.CLAD92Z plug at one end and open at the other end; 2 m; see Table 2.), an external trigger cable (terminated with an FFA.OS.302.CLAC37 plug at one end and open at the other end; 5 m; see table 3.) and an earth cable (AWG 18; 4 m) comes supplied with C7942CA-02 and C7943CA-02. An optional frame grabber cable for interface with the 36-pin receptacle (see Table 1) on C7942CA-02 and C7943CA-02 is also available for synchronous signal input, video output and external control.

The voltages described above are specified at the flat panel sensor side. The impedance of the power cable attached with the flat panel sensor is low enough but it causes 0.1 V approx. drop. Therefore the voltage at the power source side should be set 0.1 V higher than the voltage specified above.

Install a noise filter on the AC power input line to prevent surges on the AC line.

To supply the synchronous signal through ExtTrgGrb, apply high level of TTL to ExtTrgLemo and IntExt, or leave them without connection. On the contrary, to use ExtTrgLemo, set high level to ExtTrgGrb and IntExt, or leave them without connection. The earth terminal must be connected to a stable earth point to eliminate noise from surroundings.

Table 1: Pin assignment of 36-pin receptacle

Pin No.	Signal	Pin No.	Signal
1	Data12+ (MSB)	19	Data12- (MSB)
2	Data11+	20	Data11-
3	Data10+	21	Data10-
4	Data9+	22	Data9-
5	Data8+	23	Data8-
6	Data7+	24	Data7-
7	Data6+	25	Data6-
8	Data5+	26	Data5-
9	Data4+	27	Data4-
10	Data3+	28	Data3-
11	Data2+	29	Data2-
12	Data1+ (LSB)	30	Data1- (LSB)
13	bin0 (TTL)	31	GND
14	bin1 (TTL)	32	GND
15	ExtTrgGrb (TTL)	33	IntExt (TTL)
16	Vsync+	34	Vsync-
17	Hsync+	35	Hsync-
18	Pclk+	36	Pclk-

Unless otherwise noted, signal level is RS-422.

36-pin receptacle: TX20A-36R-D2GF1-A1L made by JAE (Japan Aviation Electronics Industry, limited)

Mating plug: TX20A-36PH1-D2P1-D1E made by JAE (Japan Aviation Electronics Industry, limited)

Table 2: Power pin assignment and cable color

Pin No.	Color	Signal
1	Brown	+7.5 V
2	Red	Analog GND
3	Orange	-7.5 V
4	Yellow	Analog GND
5	Green	Analog +5 V
6	Blue	Digital GND
7	Purple	Digital +5 V
Shield	-	Analog GND

7-pin power receptacle: ECG.2B.307.CLV made by LEMO S. A.

Mating power plug: FGG.2B.307.CLAD92Z made by LEMO S. A.

Table 3: External trigger pin assignment and cable color

Pin No.	Color	Signal
1	Red	ExtTrgLemo (TTL)
2	Black	Signal GND
Shield	-	Analog GND

2-pin receptacle: ECP.OS.302.CLL made by LEMO S. A.

Mating plug: FFA.OS.302.CLAC37 made by LEMO S. A.

Flat panel sensor C7942CA-02, C7943CA-02

■ Connection

Install the frame grabber board into the PC by the manufacturer's instructions. When a general-purpose frame grabber board is used, binning or trigger operation for bin0, bin1, IntExt and ExtTrgGrb can be controlled with its digital I/O control.

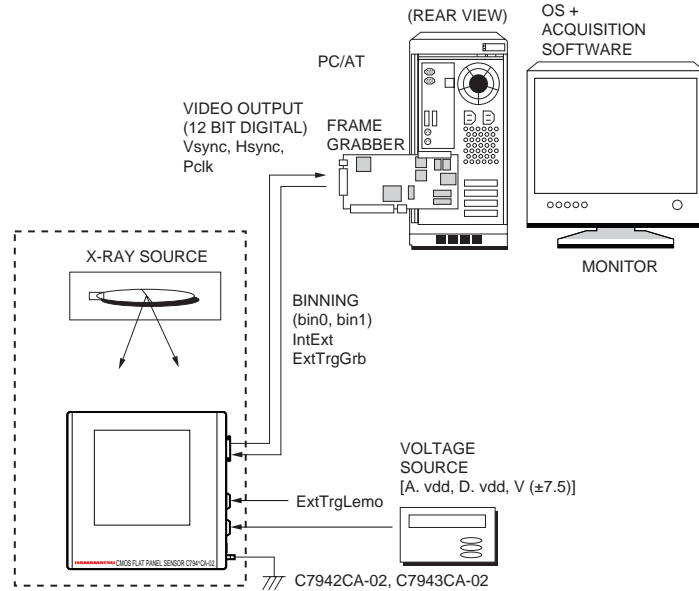

KACCC0217ED

■ Dimensional outline (unit: mm, tolerance: ± 1 mm unless otherwise noted)

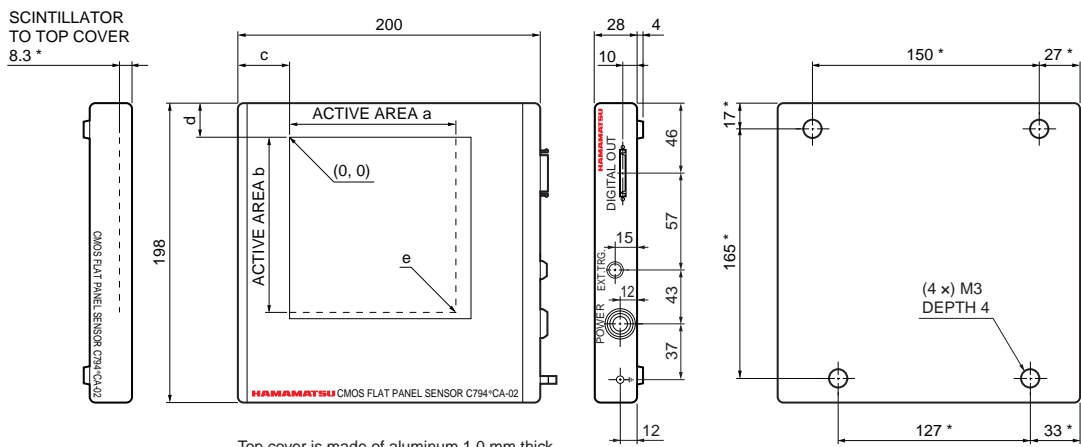

Top cover is made of aluminum 1.0 mm thick.
weight: 2.4 kg

* ± 0.5 mm

	C7942CA-02	C7943CA-02
a	112	121.6
b	117.2	122
c	33.5	31.1
d	22.9	20.5
e	(2239, 2343)	(1215, 1219)

KACCA0135ED

■ Notice

- Do not subject the Flat Panel Sensors to strong vibration or shock. (Strong shock such as drop impacts may cause permanent damage to these sensors.)
- Users must take responsibility for implementing X-ray shielding safety measures to avoid the risk of X-ray exposure.
- Data listed in this datasheet is defined at the time of shipment. Characteristics may vary somewhat due to exposure to X-rays so take proper countermeasures such as making periodic image correction.
- This product is warranted for a period of 12 months after the date of the shipment.
The warranty is limited to make a replacement or repair of any defective product due to defects in workmanship or materials used in manufacture. The warranty does not cover loss or damage caused by natural disaster, misuse (including modifications and any use not complying with the environment, application, usage and storage conditions described in this datasheet), or total radiation dose over 1 million Roentgen (less than 100 kVp) even within the warranty period.
- As described above, flat panel sensors have limited resistance to radiation. This must be taken into account when using a flat panel sensor under continuous irradiation (in-line non-destructive inspection, etc.)
When using flat panel sensors in non-destructive inspection equipment, please contact us and provide information such as irradiation conditions.

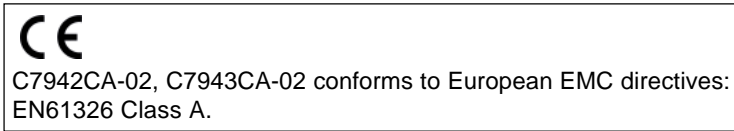

■ Optional frame grabber cables

Frame grabber	Cable type No.	Cable length	Cable end	Cable end
General-purpose	A8406-31	5 m	TX20A-36PH1-D2P1-D1E *8	open
	A8406-36	7 m		
	A8406-37	10 m		
	A8406-38	12 m		
IMAQ PCI-1424 *7	A8406-32	5 m		PCS-XE100MA+ *9
	A8406-33	7 m		
	A8406-34	10 m		
	A8406-35	12 m		

*7: Made by NI (National Instruments Corporation)

*8: Made by JAE (Japan Aviation Electronics Industry, Limited)

*9: Made by Honda Tsushin Kogyo Co. Ltd.

Note: The detailed information for these optional cable is shown in the datasheet of A8406 series.