

PRELIMINARY
 Notice: This is not a final specification.
 Some parametric limits are subject to change.

MITSUBISHI Pch POWER MOSFET

FX50KMJ-06

HIGH-SPEED SWITCHING USE

FX50KMJ-06

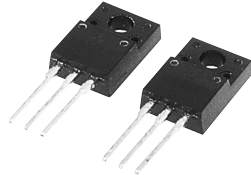

- 4V DRIVE
- V_{DSS} -60V
- $r_{DS(ON)}(MAX)$ 18.9m Ω
- I_D -50A
- Integrated Fast Recovery Diode (TYP.) 70ns
- V_{iso} 2000V

OUTLINE DRAWING

Dimensions in mm

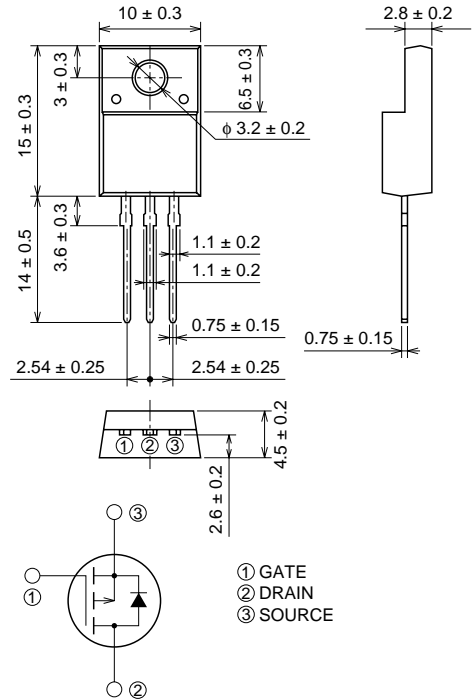

TO-220FN

APPLICATION

Motor control, Lamp control, Solenoid control
 DC-DC converter, etc.

MAXIMUM RATINGS (Tc = 25°C)

Symbol	Parameter	Conditions	Ratings	Unit
V_{DSS}	Drain-source voltage	$V_{GS} = 0V$	-60	V
V_{GSS}	Gate-source voltage	$V_{DS} = 0V$	±20	V
I_D	Drain current		-50	A
I_{DM}	Drain current (Pulsed)		-200	A
I_{DA}	Avalanche drain current (Pulsed)	$L = 50\mu H$	-50	A
I_S	Source current		-50	A
I_{SM}	Source current (Pulsed)		-200	A
P_D	Maximum power dissipation		35	W
T_{ch}	Channel temperature		-55 ~ +150	°C
T_{stg}	Storage temperature		-55 ~ +150	°C
V_{iso}	Isolation voltage	AC for 1minute, Terminal to case	2000	V
—	Weight	Typical value	2.0	g

Jan.1999

PRELIMINARY
 Notice: This is not a final specification.
 Some parametric limits are subject to change.

ELECTRICAL CHARACTERISTICS (Tch = 25°C)

Symbol	Parameter	Test conditions	Limits			Unit
			Min.	Typ.	Max.	
V (BR) DSS	Drain-source breakdown voltage	ID = -1mA, VGS = 0V	-60	—	—	V
IGSS	Gate-source leakage current	VGS = ±20V, VDS = 0V	—	—	±0.1	μA
IDSS	Drain-source leakage current	VDS = -60V, VGS = 0V	—	—	-0.1	mA
VGS (th)	Gate-source threshold voltage	ID = -1mA, VDS = -10V	-1.3	-1.8	-2.3	V
rDS (ON)	Drain-source on-state resistance	ID = -25A, VGS = -10V	—	15.0	18.9	mΩ
rDS (ON)	Drain-source on-state resistance	ID = -25A, VGS = -4V	—	23	32	mΩ
VDS (ON)	Drain-source on-state voltage	ID = -25A, VGS = -10V	—	-0.38	-0.47	V
yfs	Forward transfer admittance	ID = -25A, VDS = -10V	—	49	—	S
Ciss	Input capacitance	VDS = -10V, VGS = 0V, f = 1MHz	—	11610	—	pF
Coss	Output capacitance		—	1355	—	pF
Crss	Reverse transfer capacitance		—	687	—	pF
td (on)	Turn-on delay time		—	73	—	ns
tr	Rise time	VDD = -30V, ID = -25A, VGS = -10V, RGEN = RGS = 50Ω	—	137	—	ns
td (off)	Turn-off delay time		—	822	—	ns
tf	Fall time		—	320	—	ns
VSD	Source-drain voltage		IS = -25A, VGS = 0V	—	-1.0	-1.5
Rth (ch-c)	Thermal resistance	Channel to case	—	—	3.57	°C/W
trr	Reverse recovery time	IS = -50A, dis/dt = 100A/μs	—	70	—	ns

PERFORMANCE CURVES

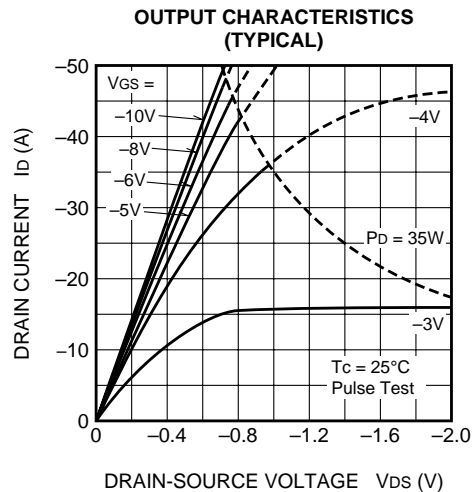
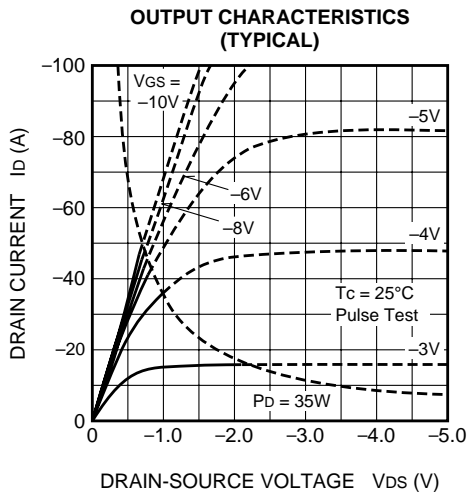
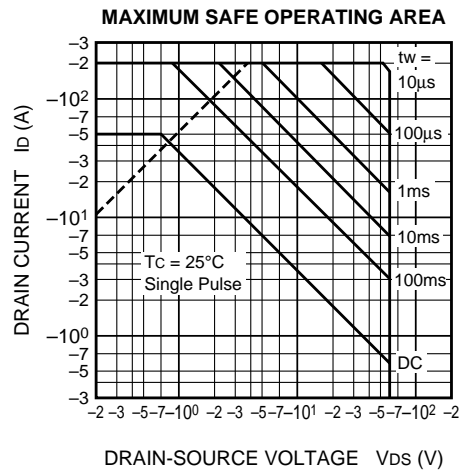
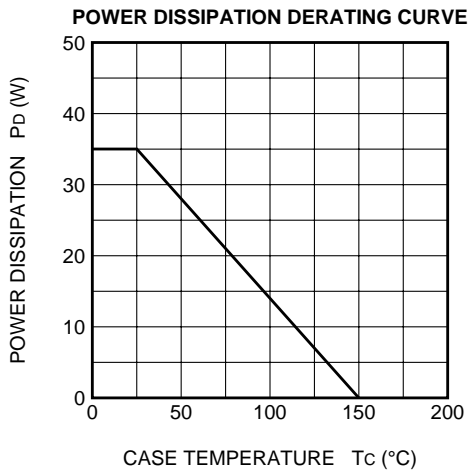

PRELIMINARY
 Notice: This is not a final specification.
 Some parametric limits are subject to change.

ON-STATE VOLTAGE VS. GATE-SOURCE VOLTAGE (TYPICAL)

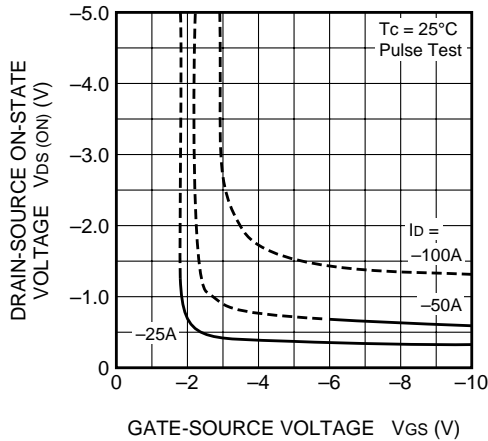

ON-STATE RESISTANCE VS. DRAIN CURRENT (TYPICAL)

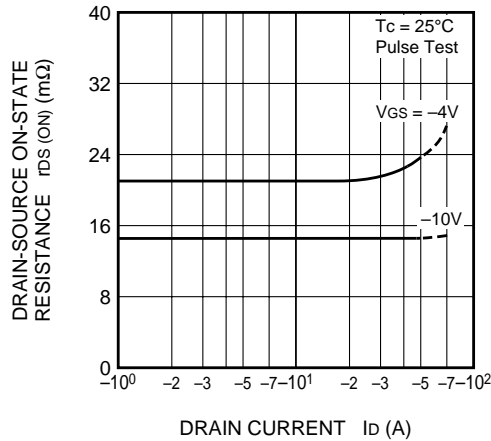

TRANSFER CHARACTERISTICS (TYPICAL)

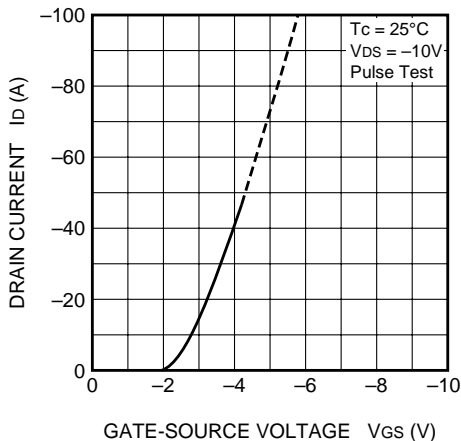

FORWARD TRANSFER ADMITTANCE VS. DRAIN CURRENT (TYPICAL)

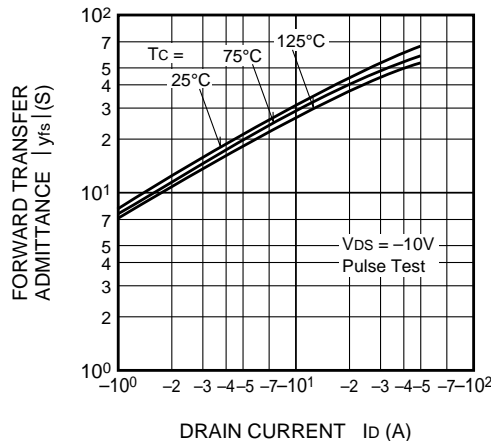

CAPACITANCE VS. DRAIN-SOURCE VOLTAGE (TYPICAL)

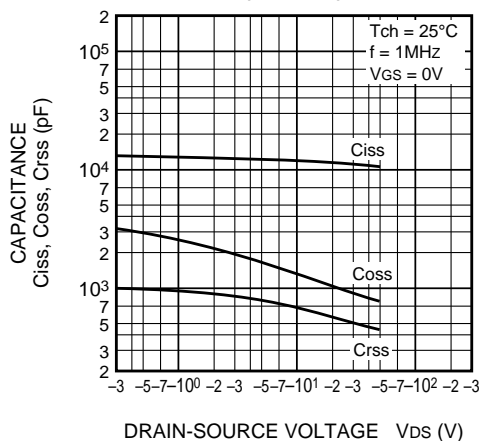

SWITCHING CHARACTERISTICS (TYPICAL)

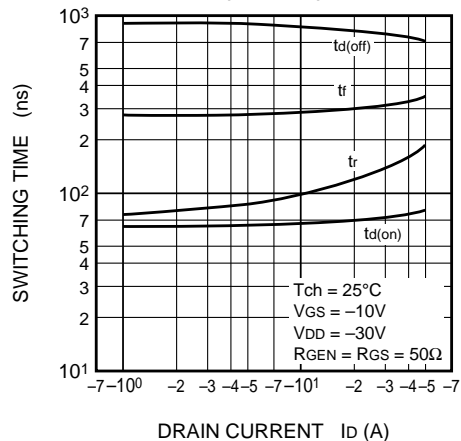

PRELIMINARY
 Notice: This is not a final specification.
 Some parametric limits are subject to change.

GATE-SOURCE VOLTAGE VS. GATE CHARGE (TYPICAL)

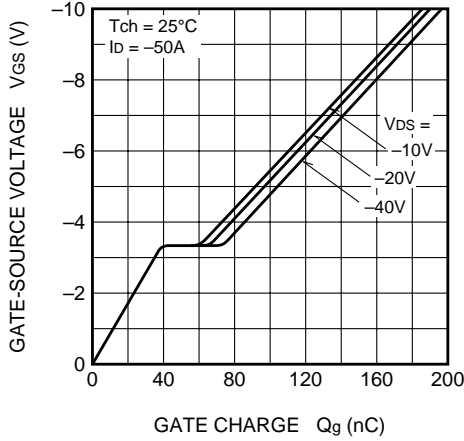

SOURCE-DRAIN DIODE FORWARD CHARACTERISTICS (TYPICAL)

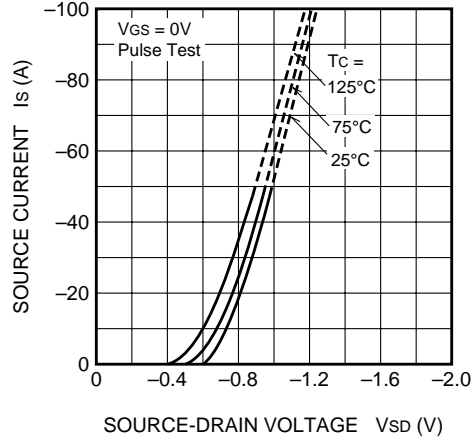

ON-STATE RESISTANCE VS. CHANNEL TEMPERATURE (TYPICAL)

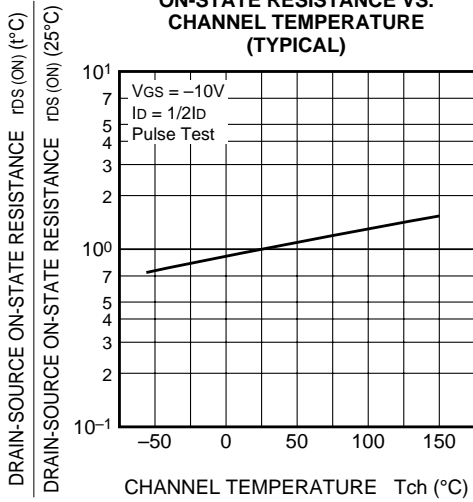

THRESHOLD VOLTAGE VS. CHANNEL TEMPERATURE (TYPICAL)

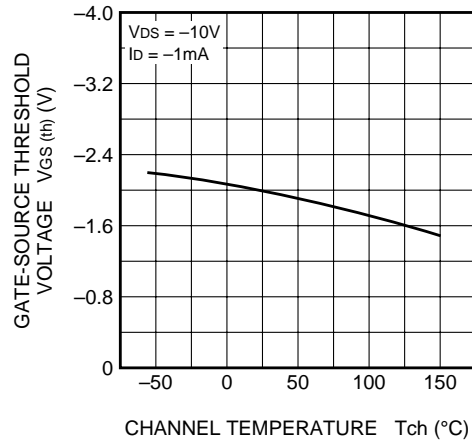

BREAKDOWN VOLTAGE VS. CHANNEL TEMPERATURE (TYPICAL)

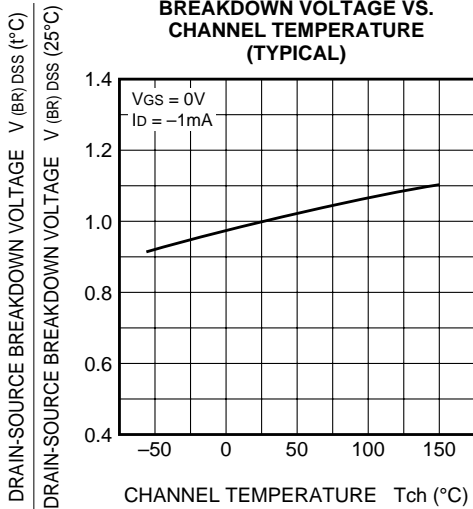

TRANSIENT THERMAL IMPEDANCE CHARACTERISTICS

