

CDBMH220-HF Thru. CDBMH2100-HF

Reverse Voltage: 20 to 100 Volts

Forward Current: 2.0 Amp

RoHS Device

Halogen Free

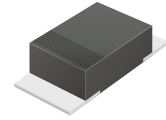

Features

- Excellent power dissipation offers better reverse leakage current and thermal resistance.
- Low profile surface mounted application in order to optimize board space.
- Low power loss, high efficiency.
- High current capability, low forward voltage drop.
- High surge capability.
- Guardring for overvoltage protection.
- Ultra high-speed switching.
- Silicon epitaxial planar chip, metal silicon junction.
- Heat sink bottom.
- Lead-free parts meet environmental standards of MIL-STD-19500/228

Mechanical data

- Case: Molded plastic, SOD-123T/Mini SMA.
- Terminals: Solderable per MIL-STD-750, method 2026.
- Polarity: Indicated by cathode band.
- Weight: 0.018 grams approx.

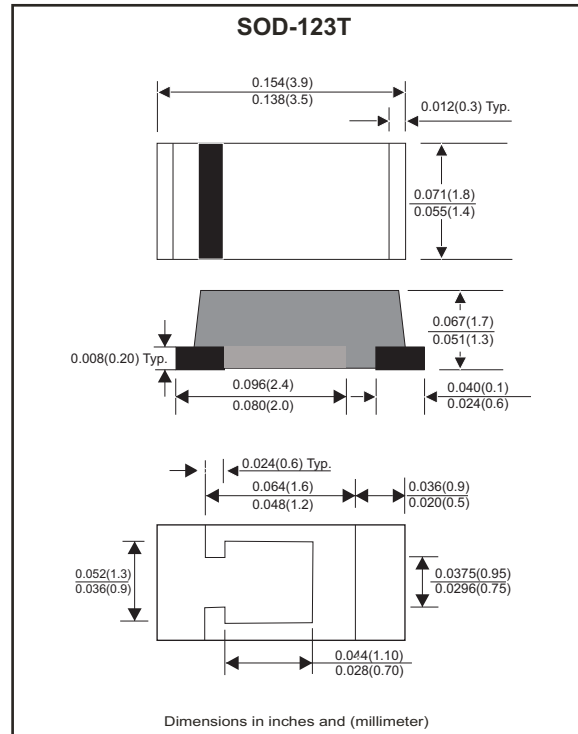

Electrical Characteristics (at T_A=25°C unless otherwise noted)

Parameter	Symbol	CDBMH 220-HF	CDBMH 230-HF	CDBMH 240-HF	CDBMH 250-HF	CDBMH 260-HF	CDBMH 280-HF	CDBMH 2100-HF	Unit
Max. Repetitive peak reverse voltage	V _{RRM}	20	30	40	50	60	80	100	V
Max. Continuous reverse voltage	V _R	20	30	40	50	60	80	100	V
Max. RMS voltage	V _{RMS}	14	21	28	35	42	56	70	V
Max. Forward rectified current	I _O	2.0							A
Max. Forward voltage at I _F =2.0A	V _F	0.50			0.70		0.85		V
Max. Forward surge current, 8.3ms single half sine-wave superimposed on rated load (JEDEC method)	I _{FSM}	50							A
Max.Reverse current	V _R =V _{RRM} T _J =25°C	0.2							mA
	V _R =V _{RRM} T _J =100°C	10							
Typ. Thermal resistance	R _{θJC}	35							°C/W
Typ. Diode Junction capacitance (Note 1)	C _J	160							pF
Operating temperature	T _J	-55 to +125			-55 to +150				°C
Storage temperature range	T _{STG}	-65 to +175							°C

Note : 1. F=1MHz and applied 4V DC reverse voltage

Rating and Characteristic Curves (CDBMH220-HF Thru. CDBMH2100-HF)

Fig.1- Typical Current Derating Curve

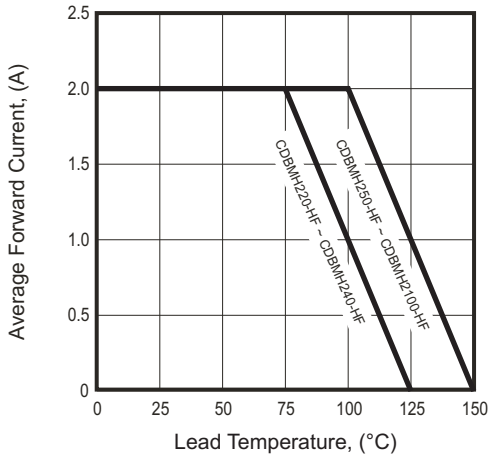

Fig.2- Typical Forward Characteristics

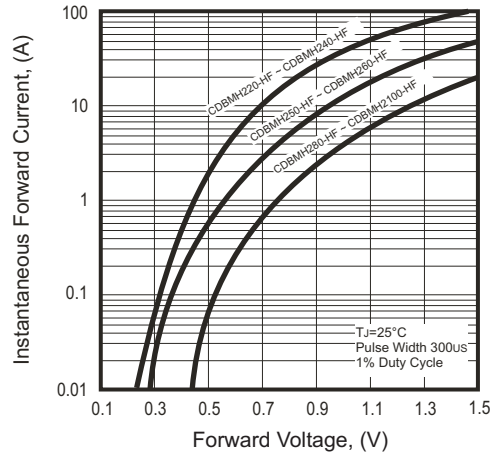

Fig.3- Maximum Non-repetitive Forward Surge Current

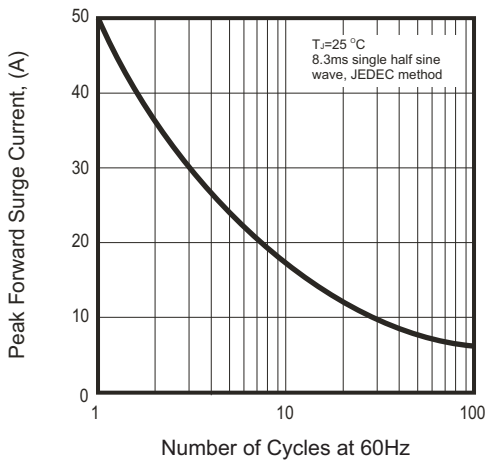

Fig.4- Typical Junction Capacitance

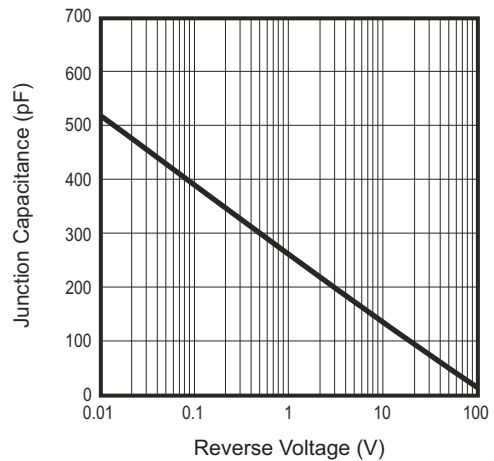
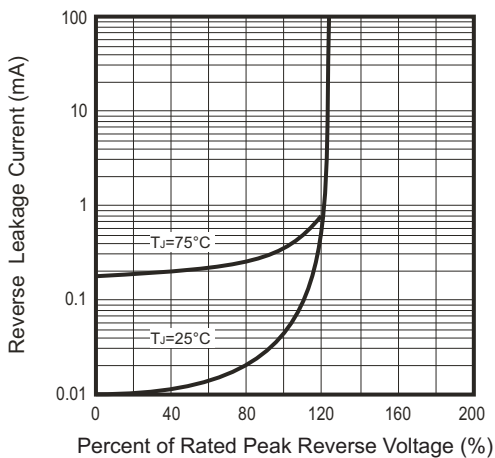
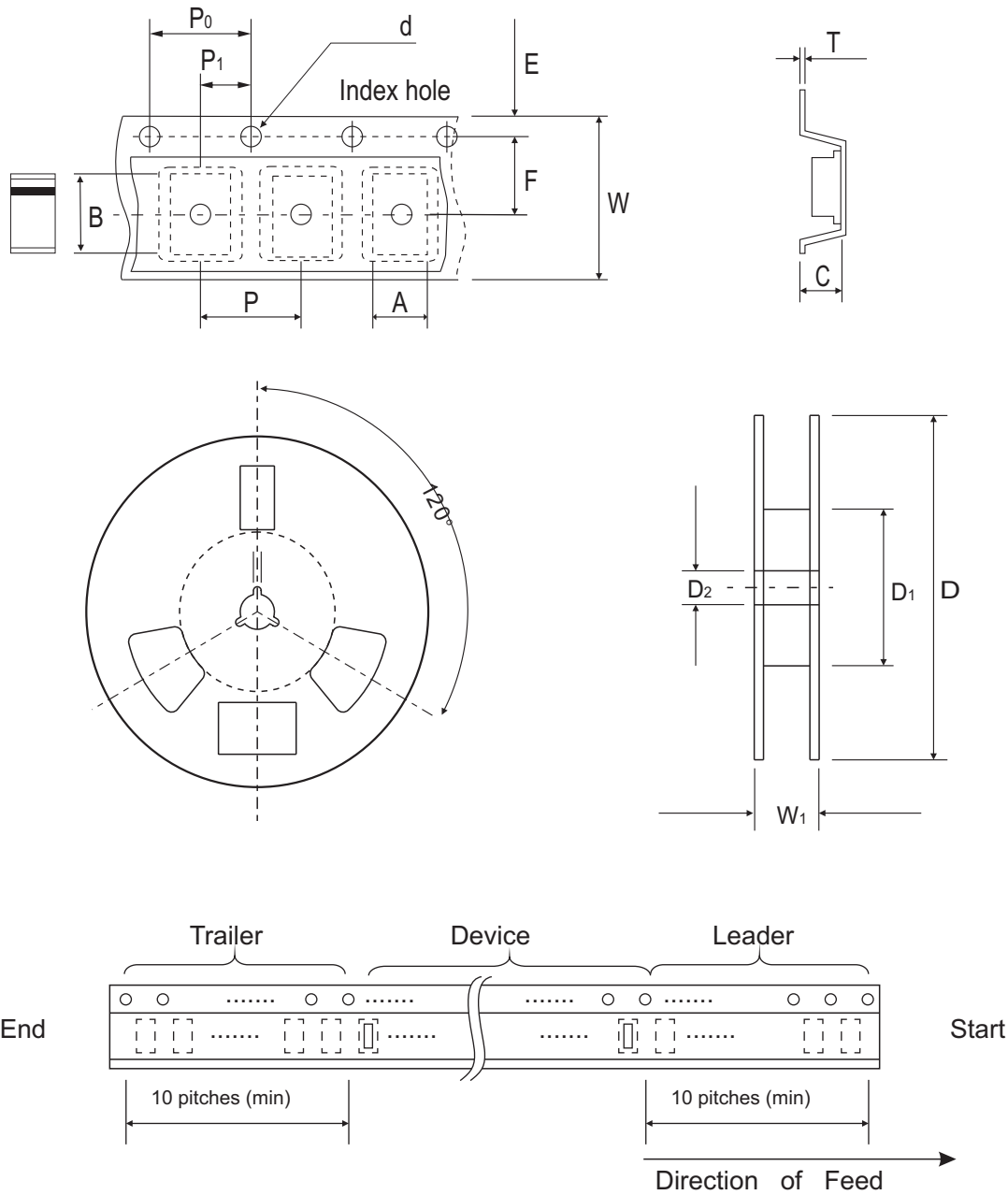

Fig.5- Reverse Characteristics



Reel Taping Specification



Mini-SMA / SOD-123T	SYMBOL	A	B	C	d	D	D1	D2
	(mm)	1.90 ± 0.10	3.90 ± 0.10	1.68 ± 0.10	1.50 ± 0.10	178.00 ± 2.00	62.00 (min)	13.00 ± 0.50
	(inch)	0.075 ± 0.004	0.154 ± 0.004	0.066 ± 0.004	0.059 ± 0.004	7.007 ± 0.079	2.441 (min)	0.512 ± 0.020

Mini-SMA / SOD-123T	SYMBOL	E	F	P	P0	P1	T	W	W1
	(mm)	1.75 ± 0.10	3.50 ± 0.10	4.00 ± 0.10	4.00 ± 0.10	2.00 ± 0.10	0.23 ± 0.10	8.00 ± 0.30	11.40 ± 1.00
	(inch)	0.069 ± 0.004	0.138 ± 0.004	0.157 ± 0.004	0.157 ± 0.004	0.079 ± 0.004	0.009 ± 0.04	0.315 ± 0.012	0.449 ± 0.039

Pinning information

Pin	Simplified outline	Symbol
PIN 1 Cathode PIN 2 Anode		

Marking Code

Part Number	Marking Code
CDBMH220-HF	22
CDBMH230-HF	23
CDBMH240-HF	24
CDBMH250-HF	25
CDBMH260-HF	26
CDBMH280-HF	28
CDBMH2100-HF	20



xx = Product type marking code

Suggested PAD Layout

SIZE	Mini-SMA/SOD-123T	
	(mm)	(inch)
A	1.00	0.040
B	1.00	0.040
C	1.70	0.067
D	0.50	0.020
E	1.50	0.060
F	1.10	0.044
G	0.90	0.036
H	0.85	0.034
I	0.60	0.024

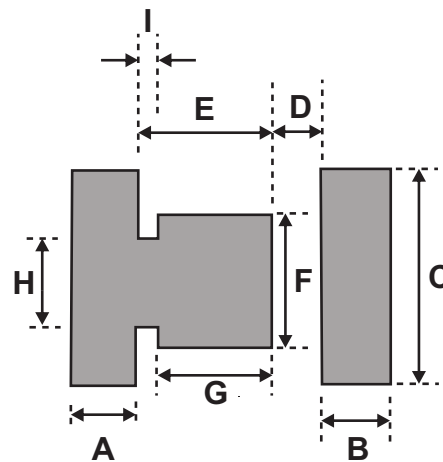

Standard Packaging

Case Type	REEL PACK	
	REEL (pcs)	Reel Size (inch)
SOD-123T	2,500	7