

SM3GZ47, SM3JZ47

AC POWER CONTROL APPLICATIONS

- Repetitive Peak Off-State Voltage : $V_{DRM} = 400, 600V$
- R.M.S ON-State Current : $I_T (RMS) = 3A$
- High Commutating (dv / dt)
- Isolation Voltage : $V_{ISOL} = 1500V AC$

MAXIMUM RATINGS

CHARACTERISTIC	SYMBOL	RATING	UNIT
Repetitive Peak Off-State Voltage	SM3GZ47	400	V
	SM3JZ47	600	
R.M.S On-State Current (Full Sine Waveform $T_c = 110^\circ C$)	$I_T (RMS)$	3	A
Peak One Cycle Surge On-State Current (Non-Repetitive)	I_{TSM}	30 (50Hz)	A
		33 (60Hz)	
$I^2 t$ Limit Value ($t = 1\sim 10ms$)	$I^2 t$	4.5	$A^2 s$
Critical Rate of Rise of On-State Current (Note 1)	di / dt	50	$A / \mu s$
Peak Gate Power Dissipation	P_{GM}	5	W
Average Gate Power Dissipation	$P_G (AV)$	0.5	W
Peak Gate Voltage	V_{GM}	10	V
Peak Gate Current	I_{GM}	2	A
Junction Temperature	T_j	-40~125	$^\circ C$
Storage Temperature Range	T_{stg}	-40~125	$^\circ C$
Isolation Voltage (AC, $t = 1min.$)	V_{ISOL}	1500	V

Unit: mm

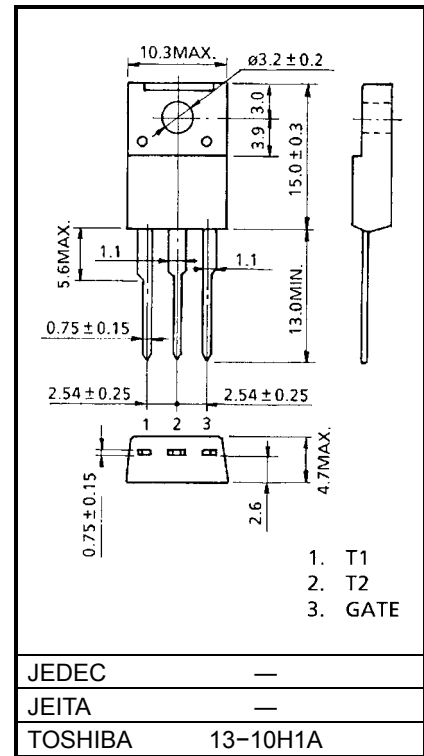

Weight: 1.7g

Note 1: di / dt test condition
 $V_{DRM} = 0.5 \times \text{Rated}$
 $I_{TM} \leq 4.5A$
 $t_{gw} \geq 10\mu s$
 $t_{gr} \leq 250ns$
 $i_{gp} = I_{GT} \times 2.0$

ELECTRICAL CHARACTERISTICS (Ta = 25°C)

CHARACTERISTIC		SYMBOL	TEST CONDITION	MIN	TYP.	MAX	UNIT	
Repetitive Peak Off-State Current		I_{DRM}	$V_{DRM} = \text{Rated}$	—	—	20	μA	
Gate Trigger Voltage	I	V_{GT}	$V_D = 12\text{V}$ $R_L = 20\Omega$	T2 (+), Gate (+)	—	—	1.5	V
	II			T2 (+), Gate (-)	—	—	1.5	
	III			T2 (-), Gate (-)	—	—	1.5	
	IV			T2 (-), Gate (+)	—	—	—	
Gate Trigger Current	I	I_{GT}	$V_D = 12\text{V}$ $R_L = 20\Omega$	T2 (+), Gate (+)	—	—	20	mA
	II			T2 (+), Gate (-)	—	—	20	
	III			T2 (-), Gate (-)	—	—	20	
	IV			T2 (-), Gate (+)	—	—	—	
Peak On-State Voltage		V_{TM}	$I_{TM} = 4.5\text{A}$	—	—	1.5	V	
Gate Non-Trigger Voltage		V_{GD}	$V_D = \text{Rated}, T_c = 125^\circ\text{C}$	0.2	—	—	V	
Holding Current		I_H	$V_D = 12\text{V}, I_{TM} = 1\text{A}$	—	—	30	mA	
Thermal Resistance		$R_{th(j-c)}$	Junction to Case, AC	—	—	4.2	$^\circ\text{C} / \text{W}$	
Critical Rate of Rise of Off-State Voltage		dv / dt	$V_{DRM} = \text{Rated}, T_j = 125^\circ\text{C}$ Exponential Rise	—	300	—	$\text{V} / \mu\text{s}$	
Critical Rate of Rise of Off-State Voltage at Commutation		$(dv / dt)_c$	$V_{DRM} = 400\text{V}, T_j = 125^\circ\text{C}$ $(di / dt)_c = -2.0\text{A} / \text{ms}$	10	—	—	$\text{V} / \mu\text{s}$	

MARKING

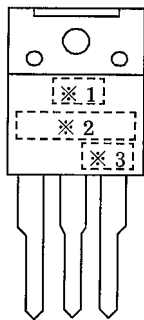

NUMBER	SYMBOL		MARK
* 1	TOSHIBA PRODUCT MARK		
* 2	TYPE	SM3GZ47	M3GZ47
		SM3JZ47	M3JZ47
* 3	Lot Number Month (Starting from Alphabet A) Year (Last Decimal Digit of the Current Year)		Example 8A : January 1998 8B : February 1998 8L : December 1998

GATE TRIGGER CHARACTERISTIC

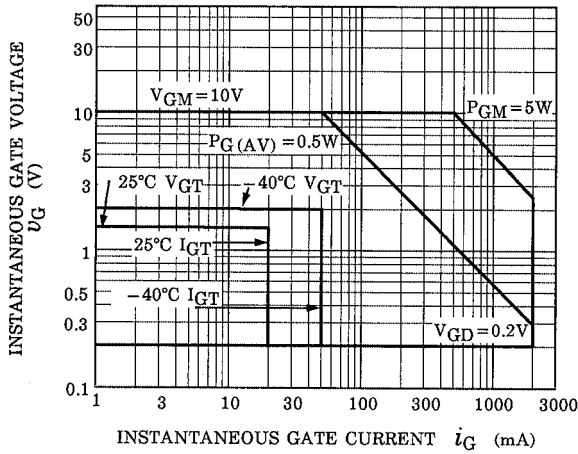

SURGE ON-STATE CURRENT (NON-REPETITIVE)

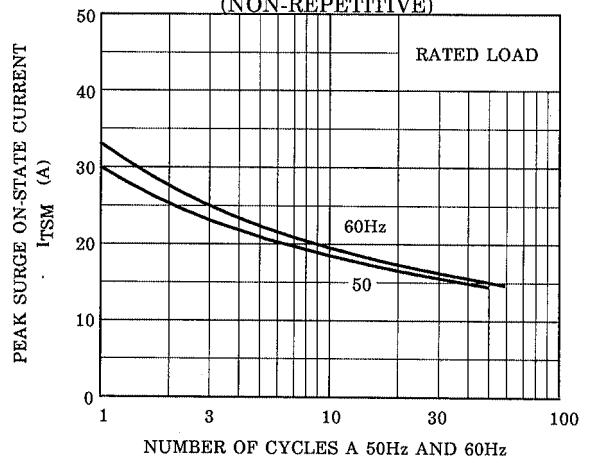

$i_T - v_T$

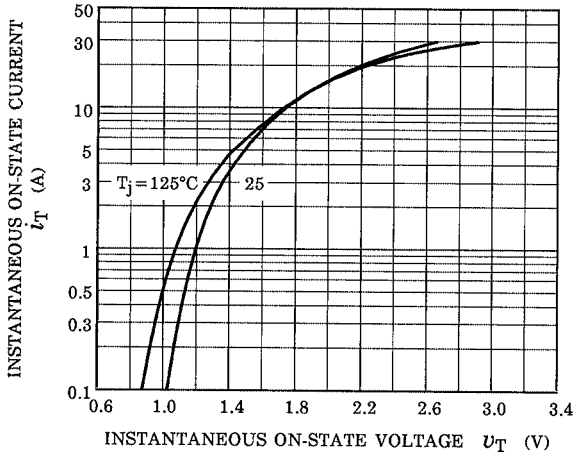

$I_{GT}(T_c) / I_{GT}(T_c = 25^\circ\text{C}) - T_c$ (TYPICAL)

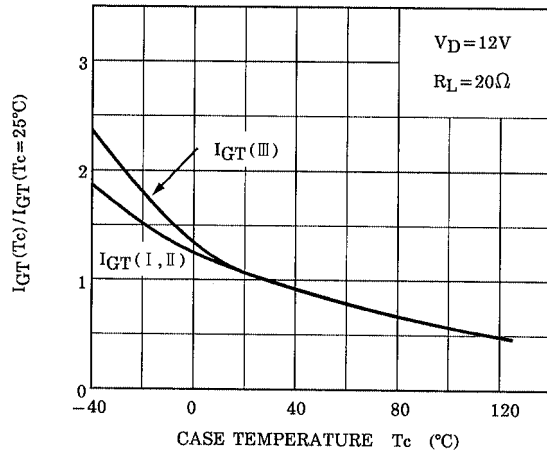

$V_{GT}(T_c) / V_{GT}(T_c = 25^\circ\text{C}) - T_c$ (TYPICAL)

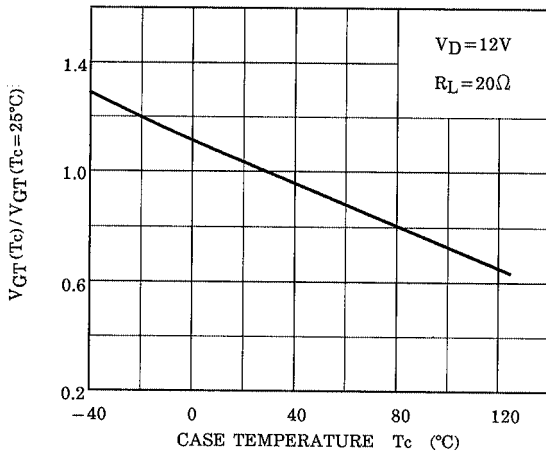

$I_H(T_c) / I_H(T_c = 25^\circ\text{C}) - T_c$ (TYPICAL)

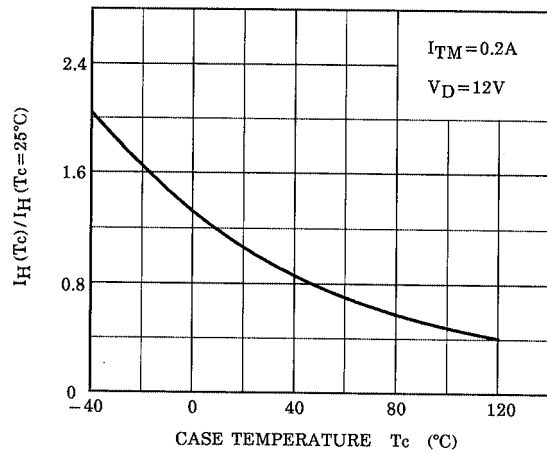

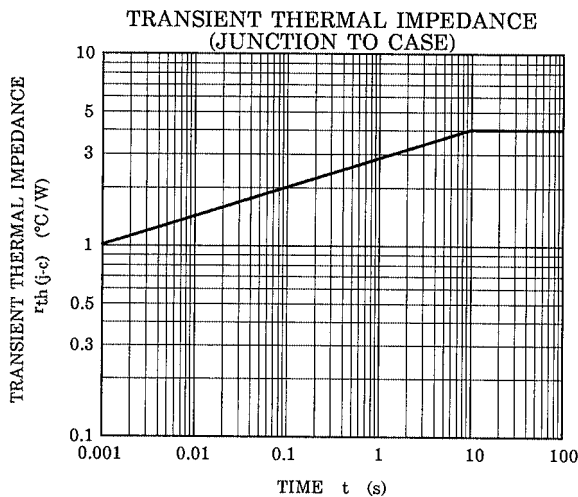
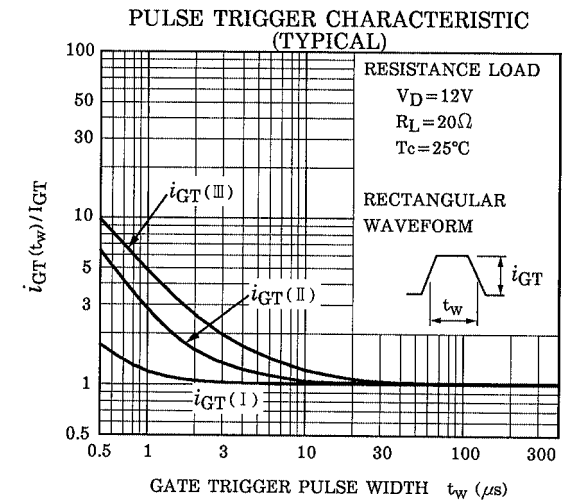
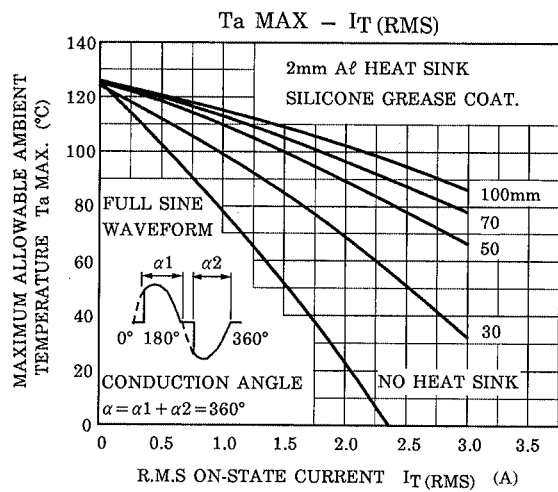
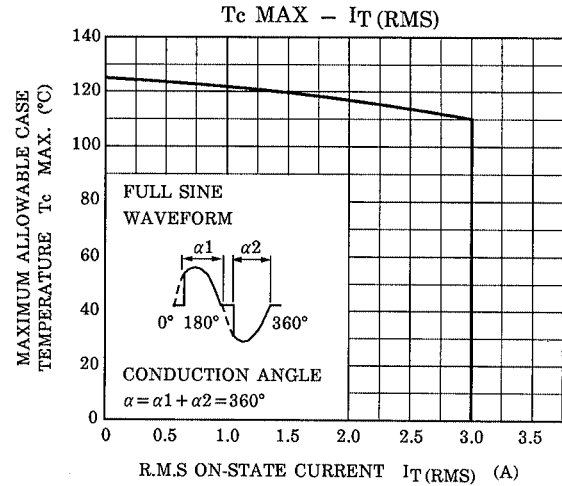
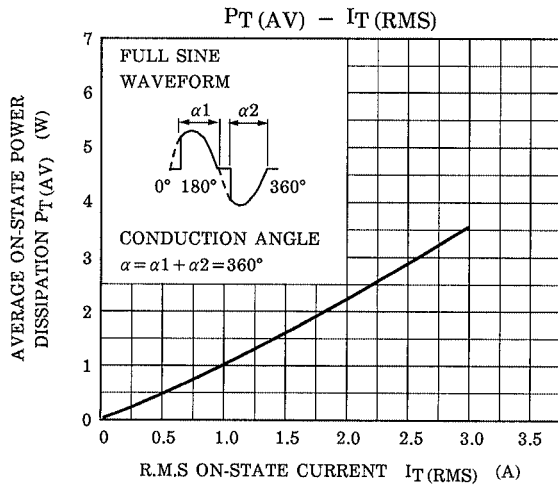

RESTRICTIONS ON PRODUCT USE

000707EAA

- TOSHIBA is continually working to improve the quality and reliability of its products. Nevertheless, semiconductor devices in general can malfunction or fail due to their inherent electrical sensitivity and vulnerability to physical stress. It is the responsibility of the buyer, when utilizing TOSHIBA products, to comply with the standards of safety in making a safe design for the entire system, and to avoid situations in which a malfunction or failure of such TOSHIBA products could cause loss of human life, bodily injury or damage to property.
In developing your designs, please ensure that TOSHIBA products are used within specified operating ranges as set forth in the most recent TOSHIBA products specifications. Also, please keep in mind the precautions and conditions set forth in the "Handling Guide for Semiconductor Devices," or "TOSHIBA Semiconductor Reliability Handbook" etc..
- The TOSHIBA products listed in this document are intended for usage in general electronics applications (computer, personal equipment, office equipment, measuring equipment, industrial robotics, domestic appliances, etc.). These TOSHIBA products are neither intended nor warranted for usage in equipment that requires extraordinarily high quality and/or reliability or a malfunction or failure of which may cause loss of human life or bodily injury ("Unintended Usage"). Unintended Usage include atomic energy control instruments, airplane or spaceship instruments, transportation instruments, traffic signal instruments, combustion control instruments, medical instruments, all types of safety devices, etc.. Unintended Usage of TOSHIBA products listed in this document shall be made at the customer's own risk.
- The information contained herein is presented only as a guide for the applications of our products. No responsibility is assumed by TOSHIBA CORPORATION for any infringements of intellectual property or other rights of the third parties which may result from its use. No license is granted by implication or otherwise under any intellectual property or other rights of TOSHIBA CORPORATION or others.
- The information contained herein is subject to change without notice.