

Printed Circuit Board Connectors

Technical Data

BL3.50 + BLZ/SL Series

	UL		CSA*		VDE		
	3.50 mm	All Others	3.50 mm	All Others	3.50 mm	5.00/5.08 mm	7.50/7.62 mm
Pitch	3.50 mm	All Others	3.50 mm	All Others	3.50 mm	5.00/5.08 mm	7.50/7.62 mm
Rated Voltage	300V	300V	300V	300V	125V-Gr.C	250V-Gr.C	3500V-Gr.C
Rated Current	10A	10A	10A	10A	12A	12A	15A
Wire Size	22... 14 AWG	22... 12 AWG	28... 14 AWG	26... 12 AWG	1.5 mm ²	2.5 mm ²	2.5 mm ²
Strip Length mm (in.)	7 (.24)	7 (.24)	7 (.24)	7 (.24)	7 (.24)	7 (.24)	7 (.24)
Torque Nm (lb. in.)	.25 (2.25)	.50 (4.50)	.25 (2.25)	.50 (4.50)	.25 (2.25)	.50 (4.50)	.50 (4.50)
Molding Material	PBT						
Temperature Range	-50°C (-58°F) - +130°C (266°F)						
Contact	CuSn						
Plating	Tin-Plated						
Solder Pin Length	4.5 mm (Standard)**						
Connection	Screw Clamp						

*Standard UL 1050
Standard CSA C22.2 No. 158
VDE Standard 0110b 2.79

**Other lengths available upon request.

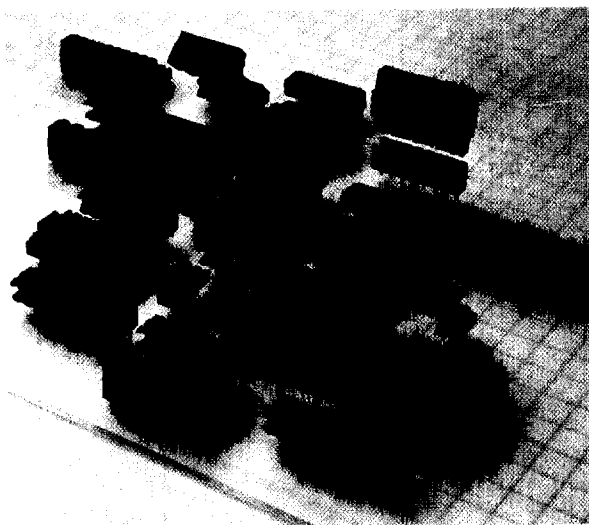

BLA/SLA Series

BLA/SLA Technical Data	UL	CSA	VDE
Ratings (industrial)	300V / 10A	300V / 10A	250V / 8A
Ratings (commercial)	250V / 10A		380V / 8A
Wire size	#22...12 AWG	#26...12 AWG	#28 ...16 AWG
Strip length mm (in)	7mm (.28")		
Torque Nm (lb. in)	0.5 (4.5")		
Molding material	Polyester		
Pin length	4.5mm (.177")		
Hole diameter for pins	1.3 +/- .1mm (.051")		

BLAC Technical Data	UL	CSA	VDE
Ratings (industrial)	300V / 10A	300V / 10A	250V / 10A
Ratings (commercial)	250V / 10A		380V / 10A
Wire size	#22...14 AWG	#20...14 AWG	
Crimp range			1.5 to 2.5mm ² 0.5 to 1mm ²

BL/SL Series

Technical Data	UL	CSA	VDE
Ratings (industrial)	300V / 10A	300V / 10A	250V / 8A BL TOP 10A
Ratings (commercial)	250V / 10A		380V / 8A
Wire size BL	#22...12 AWG	#26...14 AWG	#26 ...6 AWG
Wire size BL TOP	#22...14 AWG	#26...14 AWG	#28...14 AWG
Strip length mm (in) BL	6mm (.24 in)		
Strip length mm (in) BL TOP	10mm (.39 in)		
Torque Nm (lb. in) BL	0.5 (4.5)		
Torque Nm (lb. in) BL TOP	0.5 (4.5)		
Molding material	Polyamide		

Printed Circuit Board Connectors

BL/SL 3.50 Series
3.50 mm Pitch Plugs

BL 3.50
180° Orientation
Non-Locking
Screw Clamp

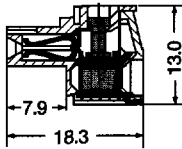

BL 3.50 F
180° Orientation
Locking
Screw Clamp

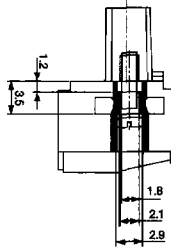
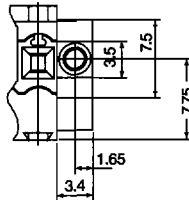
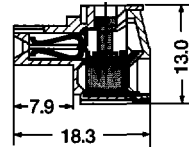
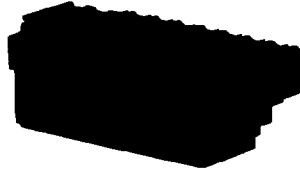

BL 3.5 LH
180° Orientation
Non-Locking
Quick Release Mechanism
Screw Clamp

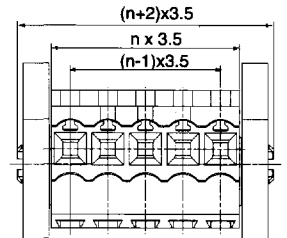
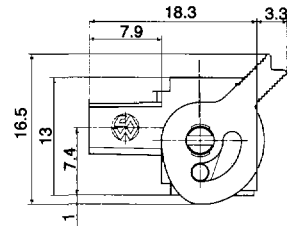
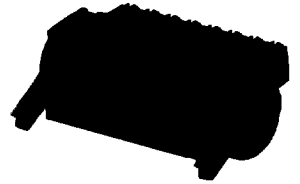

Part No.	Type	Part No.	Part No.	Type	Part No.	Part No.	Type	Part No.
2	BL 3.5/2 BK	161567	2	BL 3.5/2 F BK	161578	2	BL 3.5/2 LH BK	168788
3	BL 3.5/3 BK	161568	3	BL 3.5/3 F BK	161579	3	BL 3.5/3 LH BK	168789
4	BL 3.5/4 BK	161569	4	BL 3.5/4 F BK	161580	4	BL 3.5/4 LH BK	168790
5	BL 3.5/5 BK	161409	5	BL 3.5/5 F BK	161581	5	BL 3.5/5 LH BK	168791
6	BL 3.5/6 BK	161018	6	BL 3.5/6 F BK	161582	6	BL 3.5/6 LH BK	168792
7	BL 3.5/7 BK	161019	7	BL 3.5/7 F BK	161583	7	BL 3.5/7 LH BK	168793
8	BL 3.5/8 BK	161570	8	BL 3.5/8 F BK	161584	8	BL 3.5/8 LH BK	168794
9	BL 3.5/9 BK	161571	9	BL 3.5/9 F BK	161585	9	BL 3.5/9 LH BK	168795
10	BL 3.5/10 BK	161020	10	BL 3.5/10 F BK	161586	10	BL 3.5/10 LH BK	168796
11	BL 3.5/11 BK	161572	11	BL 3.5/11 F BK	161587	11	BL 3.5/11 LH BK	168797
12	BL 3.5/12 BK	161573	12	BL 3.5/12 F BK	161588	12	BL 3.5/12 LH BK	168798
13	BL 3.5/13 BK	161574	13	BL 3.5/13 F BK	161589	13	BL 3.5/13 LH BK	168799
14	BL 3.5/14 BK	161575	14	BL 3.5/14 F BK	161590	14	BL 3.5/14 LH BK	168800
15	BL 3.5/15 BK	161576	15	BL 3.5/15 F BK	161591	15	BL 3.5/15 LH BK	168801
16	BL 3.5/16 BK	161577	16	BL 3.5/16 F BK	161592	16	BL 3.5/16 LH BK	168802
17	BL 3.5/17 BK	162037	17	BL 3.5/17 F BK	162084	17	BL 3.5/17 LH BK	168803
18	BL 3.5/18 BK	162038	18	BL 3.5/18 F BK	162085	18	BL 3.5/18 LH BK	168804
19	BL 3.5/19 BK	162039	19	BL 3.5/19 F BK	162086	19	BL 3.5/19 LH BK	168805
20	BL 3.5/20 BK	162040	20	BL 3.5/20 F BK	162087	20	BL 3.5/20 LH BK	168806
21	BL 3.5/21 BK	162041	21	BL 3.5/21 F BK	162088	21	BL 3.5/21 LH BK	168807
22	BL 3.5/22 BK	162042	22	BL 3.5/22 F BK	162089	22	BL 3.5/22 LH BK	168808
23	BL 3.5/23 BK	162043	23	BL 3.5/23 F BK	162090	23	BL 3.5/23 LH BK	168809
24	BL 3.5/24 BK	162044	24	BL 3.5/24 F BK	162091	24	BL 3.5/24 LH BK	168810

Note: Plugs and headers are supplied with black moldings. Alternate colors are available upon request.
See pages 6/76-80 for accessories

3.50 mm Pitch Headers

SL 3.50/90
Single-Level
90° Orientation
Open End
Non-Locking

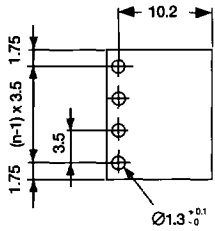
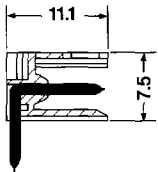

SL 3.50/90 G
Single-Level
90° Orientation
Closed End
Non-Locking

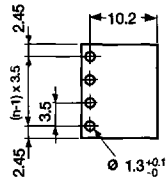
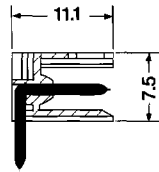

SL 3.50/90 F
Single-Level
90° Orientation
Closed End
Locking

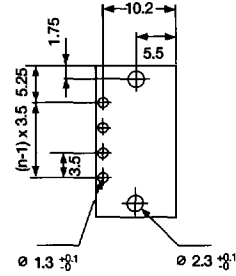
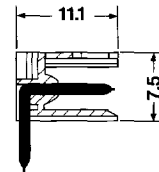

Pin No.	Type	Part No.	Pin No.	Type	Part No.	Pin No.	Type	Part No.
2	SL 3.5/90/2 BK	161413	2	SL 3.5/90/2 G BK	161416	2	SL 3.5/90/2 F BK	161553
3	SL 3.5/90/3 BK	161530	3	SL 3.5/90/3 G BK	161542	3	SL 3.5/90/3 F BK	161554
4	SL 3.5/90/4 BK	161531	4	SL 3.5/90/4 G BK	161543	4	SL 3.5/90/4 F BK	161555
5	SL 3.5/90/5 BK	161532	5	SL 3.5/90/5 G BK	161417	5	SL 3.5/90/5 F BK	161556
6	SL 3.5/90/6 BK	161533	6	SL 3.5/90/6 G BK	161544	6	SL 3.5/90/6 F BK	161557
7	SL 3.5/90/7 BK	161534	7	SL 3.5/90/7 G BK	161545	7	SL 3.5/90/7 F BK	161558
8	SL 3.5/90/8 BK	161414	8	SL 3.5/90/8 G BK	161418	8	SL 3.5/90/8 F BK	161420
9	SL 3.5/90/9 BK	161535	9	SL 3.5/90/9 G BK	161546	9	SL 3.5/90/9 F BK	161559
10	SL 3.5/90/10 BK	161536	10	SL 3.5/90/10 G BK	161547	10	SL 3.5/90/10 F BK	161560
11	SL 3.5/90/11 BK	161537	11	SL 3.5/90/11 G BK	161548	11	SL 3.5/90/11 F BK	161561
12	SL 3.5/90/12 BK	161538	12	SL 3.5/90/12 G BK	161549	12	SL 3.5/90/12 F BK	161562
13	SL 3.5/90/13 BK	161539	13	SL 3.5/90/13 G BK	161550	13	SL 3.5/90/13 F BK	161563
14	SL 3.5/90/14 BK	161540	14	SL 3.5/90/14 G BK	161551	14	SL 3.5/90/14 F BK	161564
15	SL 3.5/90/15 BK	161541	15	SL 3.5/90/15 G BK	161552	15	SL 3.5/90/15 F BK	161565
16	SL 3.5/90/16 BK	161415	16	SL 3.5/90/16 G BK	161419	16	SL 3.5/90/16 F BK	161566
17	SL 3.5/90/17 BK	161782	17	SL 3.5/90/17 G BK	161798	17	SL 3.5/90/17 F BK	161828
18	SL 3.5/90/18 BK	161783	18	SL 3.5/90/18 G BK	161799	18	SL 3.5/90/18 F BK	161829
19	SL 3.5/90/19 BK	161784	19	SL 3.5/90/19 G BK	161800	19	SL 3.5/90/19 F BK	161830
20	SL 3.5/90/20 BK	161785	20	SL 3.5/90/20 G BK	161801	20	SL 3.5/90/20 F BK	161831
21	SL 3.5/90/21 BK	161786	21	SL 3.5/90/21 G BK	161802	21	SL 3.5/90/21 F BK	161832
22	SL 3.5/90/22 BK	161787	22	SL 3.5/90/22 G BK	161803	22	SL 3.5/90/22 F BK	161833
23	SL 3.5/90/23 BK	161788	23	SL 3.5/90/23 G BK	161804	23	SL 3.5/90/23 F BK	161834
24	SL 3.5/90/24 BK	161789	24	SL 3.5/90/24 G BK	161805	24	SL 3.5/90/24 F BK	161835

Note: Plugs and headers are supplied with black moldings. Alternate colors are available upon request.
 Standard solder pin length is 4.5 mm. Other lengths are available upon request.
 See pages 6/76-80 for accessories.

Printed Circuit Board Connectors

BL/SL 3.50 Series
3.50 mm Pitch Headers

SL 3.50/110
Single-Level
110° Orientation
Closed End
Locking

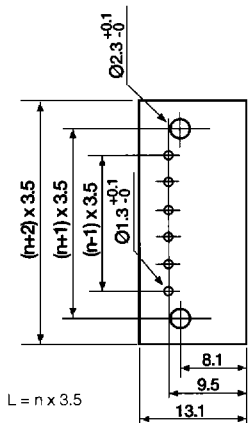
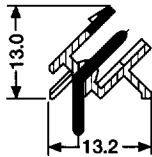

SL 3.50/135
Single-Level
135° Orientation
Closed End
Locking

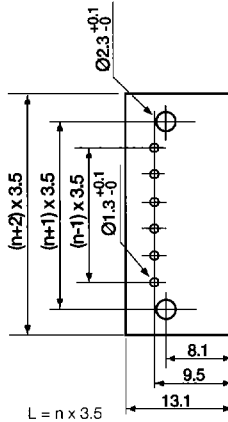
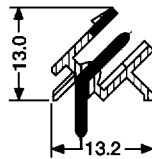

SL 3.50/180
Single-Level
180° Orientation
Open End
Non-Locking

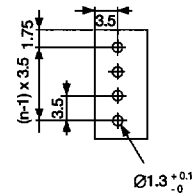
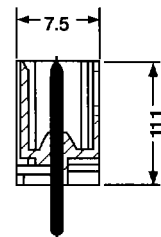

Poles	Type	Part No.	Poles	Type	Part No.	Poles	Type	Part No.
2	SL 3.5/110/2 BK	164450	2	SL 3.5/135/2 BK	164381	2	SL 3.5/180/2 BK	161421
3	SL 3.5/110/3 BK	164451	3	SL 3.5/135/3 BK	164382	3	SL 3.5/180/3 BK	161593
4	SL 3.5/110/4 BK	164452	4	SL 3.5/135/4 BK	164383	4	SL 3.5/180/4 BK	161594
5	SL 3.5/110/5 BK	164453	5	SL 3.5/135/5 BK	164384	5	SL 3.5/180/5 BK	161595
6	SL 3.5/110/6BK	164454	6	SL 3.5/135/6 BK	164385	6	SL 3.5/180/6 BK	161015
7	SL 3.5/110/7 BK	164455	7	SL 3.5/135/7 BK	164386	7	SL 3.5/180/7 BK	161016
8	SL 3.5/110/8 BK	164456	8	SL 3.5/135/8 BK	164387	8	SL 3.5/180/8 BK	161422
9	SL 3.5/110/9 BK	164457	9	SL 3.5/135/9 BK	164388	9	SL 3.5/180/9 BK	161596
10	SL 3.5/110/10 BK	164458	10	SL 3.5/135/10 BK	164389	10	SL 3.5/180/10 BK	161017
11	SL 3.5/110/11BK	164459	11	SL 3.5/135/11 BK	164390	11	SL 3.5/180/11 BK	161597
12	SL 3.5/110/12 BK	164460	12	SL 3.5/135/12 BK	164391	12	SL 3.5/180/12 BK	161598
13	SL 3.5/110/13 BK	164461	13	SL 3.5/135/13 BK	164392	13	SL 3.5/180/13 BK	161599
14	SL 3.5/110/14 BK	164462	14	SL 3.5/135/14 BK	164393	14	SL 3.5/180/14 BK	161600
15	SL 3.5/110/15 BK	164463	15	SL 3.5/135/15 BK	164394	15	SL 3.5/180/15 BK	161601
16	SL 3.5/110/16 BK	164464	16	SL 3.5/135/16 BK	164395	16	SL 3.5/180/16 BK	161423
17	SL 3.5/110/17 BK	164465	17	SL 3.5/135/17 BK	164396	17	SL 3.5/180/17 BK	161845
18	SL 3.5/110/18 BK	164466	18	SL 3.5/135/18 BK	164397	18	SL 3.5/180/18 BK	161846
19	SL 3.5/110/19 BK	164467	19	SL 3.5/135/19 BK	164398	19	SL 3.5/180/19 BK	161847
20	SL 3.5/110/20 BK	164468	20	SL 3.5/135/20 BK	164399	20	SL 3.5/180/20 BK	161848
21	SL 3.5/110/21 BK	164469	21	SL 3.5/135/21 BK	164400	21	SL 3.5/180/21 BK	161849
22	SL 3.5/110/22 BK	164470	22	SL 3.5/135/22 BK	164401	22	SL 3.5/180/22 BK	161850
23	SL 3.5/110/23 BK	164471	23	SL 3.5/135/23 BK	164402	23	SL 3.5/180/23 BK	161851
24	SL 3.5/110/24 BK	164472	24	SL 3.5/135/24 BK	164403	24	SL 3.5/180/24 BK	161852

Notes: Plugs and headers are supplied with black moldings. Alternate colors are available upon request. Standard solder pin length is 4.5 mm. Other lengths are available upon request. See pages 6/76-80 for accessories.

SL 3.5/180 G
Single-Level
180° Orientation
Closed End
Non-Locking

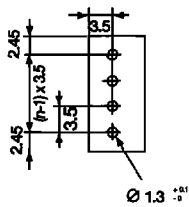
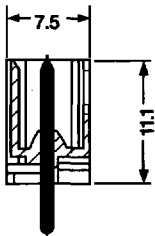
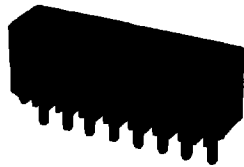

SL 3.5/180 F
Single-Level
180° Orientation
Closed End
Locking

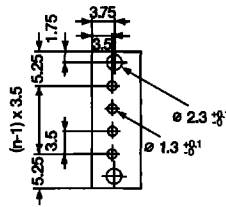
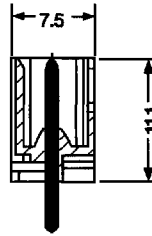

SLD 3.5/90
Double-Level In Line
90° Orientation
Open End
Non-Locking

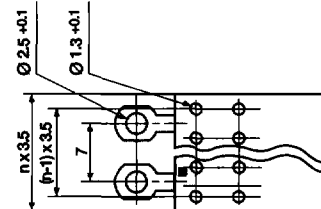
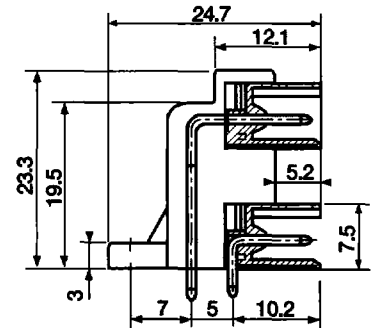
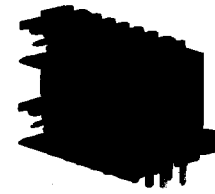

2	SL 3.5/180/2 G BK	161424	2	SL 3.5/180/2 F BK	161614	4	SLD 3.5/90/4 BK	163404
3	SL 3.5/180/3 G BK	161602	3	SL 3.5/180/3 F BK	161615	6	SLD 3.5/90/6 BK	163405
4	SL 3.5/180/4 G BK	161603	4	SL 3.5/180/4 F BK	161616	8	SLD 3.5/90/8 BK	163406
5	SL 3.5/180/5 G BK	161604	5	SL 3.5/180/5 F BK	161617	10	SLD 3.5/90/10 BK	163407
6	SL 3.5/180/6 G BK	161605	6	SL 3.5/180/6 F BK	161618	12	SLD 3.5/90/12 BK	163408
7	SL 3.5/180/7 G BK	161606	7	SL 3.5/180/7 F BK	161619	14	SLD 3.5/90/14 BK	163409
8	SL 3.5/180/8 G BK	161425	8	SL 3.5/180/8 F BK	161427	16	SLD 3.5/90/16 BK	163410
9	SL 3.5/180/9 G BK	161607	9	SL 3.5/180/9 F BK	161620	18	SLD 3.5/90/18 BK	163411
10	SL 3.5/180/10 G BK	161608	10	SL 3.5/180/10 F BK	161621	20	SLD 3.5/90/20 BK	163412
11	SL 3.5/180/11 G BK	161609	11	SL 3.5/180/11 F BK	161622	22	SLD 3.5/90/22 BK	163413
12	SL 3.5/180/12 G BK	161610	12	SL 3.5/180/12 F BK	161623	24	SLD 3.5/90/24 BK	163414
13	SL 3.5/180/13 G BK	161611	13	SL 3.5/180/13 F BK	161624	26	SLD 3.5/90/26 BK	163415
14	SL 3.5/180/14 G BK	161612	14	SL 3.5/180/14 F BK	161625	28	SLD 3.5/90/28 BK	163416
15	SL 3.5/180/15 G BK	161613	15	SL 3.5/180/15 F BK	161626	30	SLD 3.5/90/30 BK	163417
16	SL 3.5/180/16 G BK	161426	16	SL 3.5/180/16 F BK	161627	32	SLD 3.5/90/32 BK	163418
17	SL 3.5/180/17 G BK	161661	17	SL 3.5/180/17 F BK	161691	34	SLD 3.5/90/34 BK	163419
18	SL 3.5/180/18 G BK	161662	18	SL 3.5/180/18 F BK	161692	36	SLD 3.5/90/36 BK	163420
19	SL 3.5/180/19 G BK	161663	19	SL 3.5/180/19 F BK	161693	38	SLD 3.5/90/38 BK	163421
20	SL 3.5/180/20 G BK	161664	20	SL 3.5/180/20 F BK	161694	40	SLD 3.5/90/40 BK	163422
21	SL 3.5/180/21 G BK	161665	21	SL 3.5/180/21 F BK	161695	42	SLD 3.5/90/42 BK	163423
22	SL 3.5/180/22 G BK	161666	22	SL 3.5/180/22 F BK	161696	44	SLD 3.5/90/44 BK	163424
23	SL 3.5/180/23 G BK	161667	23	SL 3.5/180/23 F BK	161697	46	SLD 3.5/90/46 BK	163425
24	SL 3.5/180/24 G BK	161668	24	SL 3.5/180/24 F BK	161698	48	SLD 3.5/90/48 BK	163426

Notes: Plugs and headers are supplied with black moldings. Alternate colors are available upon request.
 Standard solder pin length is 4.5 mm. Other lengths are available upon request.
 See pages 6/76-80 for accessories.

Printed Circuit Board Connectors

BL/SL 3.50 Series

3.50 mm Pitch Headers

SLD 3.50/90 G
 Double-Level In Line
 90° Orientation
 Closed End
 Non-locking

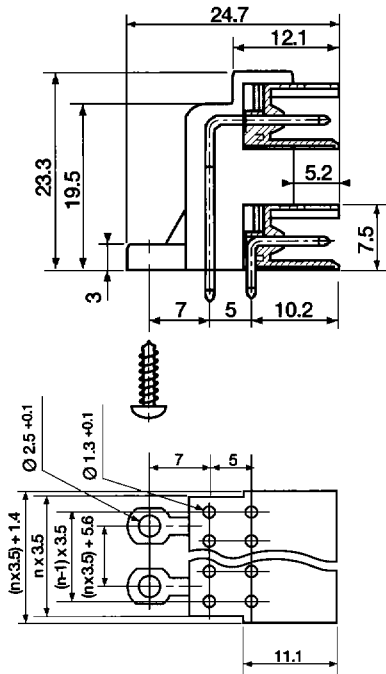
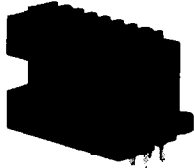

SLD 3.50/90 F
 Double-Level In Line
 90° Orientation
 Closed End
 Locking

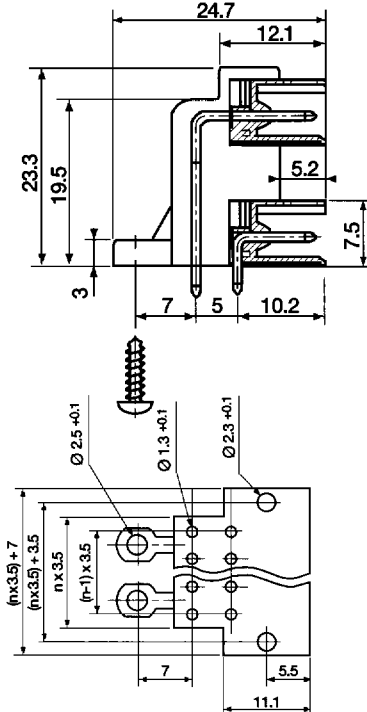
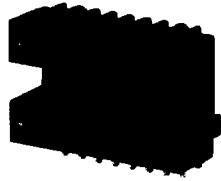

SLD 3.50V/90
 Double-Level Recessed
 90° Orientation
 Open End
 Non-locking

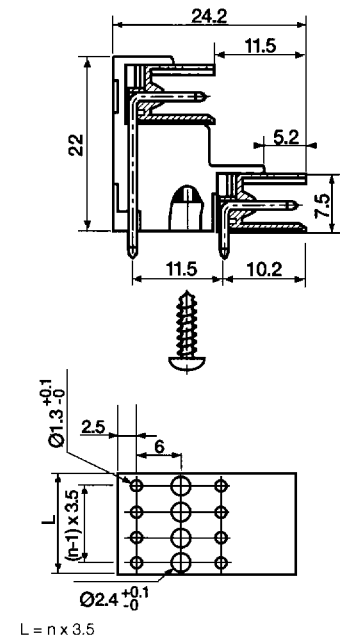
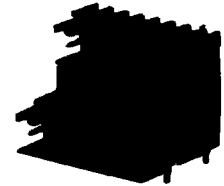

$L = n \times 3.5$

4	SLD 3.5/90/4 G BK	163427	4	SLD 3.5/90/4 F BK	163450	4	SLD 3.5V/90/4 BK	164262
6	SLD 3.5/90/6 G BK	163428	6	SLD 3.5/90/6 F BK	163451	6	SLD 3.5V/90/6 BK	169916
8	SLD 3.5/90/8 G BK	163429	8	SLD 3.5/90/8 F BK	163452	8	SLD 3.5V/90/8 BK	164263
10	SLD 3.5/90/10 G BK	163430	10	SLD 3.5/90/10 F BK	163453	10	SLD 3.5V/90/10 BK	169917
12	SLD 3.5/90/12 G BK	163431	12	SLD 3.5/90/12 F BK	163454	12	SLD 3.5V/90/12 BK	164264
14	SLD 3.5/90/14 G BK	163432	14	SLD 3.5/90/14 F BK	163455	14	SLD 3.5V/90/14 BK	169918
16	SLD 3.5/90/16 G BK	163433	16	SLD 3.5/90/16 F BK	163456	16	SLD 3.5V/90/16 BK	164265
18	SLD 3.5/90/18 G BK	163434	18	SLD 3.5/90/18 F BK	163457	18	SLD 3.5V/90/18 BK	169919
20	SLD 3.5/90/20 G BK	163435	20	SLD 3.5/90/20 F BK	163458	20	SLD 3.5V/90/20 BK	164266
22	SLD 3.5/90/22 G BK	163436	22	SLD 3.5/90/22 F BK	163459	22	SLD 3.5V/90/22 BK	169920
24	SLD 3.5/90/24 G BK	163437	24	SLD 3.5/90/24 F BK	163460	24	SLD 3.5V/90/24 BK	164267
26	SLD 3.5/90/26 G BK	163438	26	SLD 3.5/90/26 F BK	163461	26	SLD 3.5V/90/26 BK	169921
28	SLD 3.5/90/28 G BK	163439	28	SLD 3.5/90/28 F BK	163462	28	SLD 3.5V/90/28 BK	164268
30	SLD 3.5/90/30 G BK	163440	30	SLD 3.5/90/30 F BK	163463	30	SLD 3.5V/90/30 BK	169922
32	SLD 3.5/90/32 G BK	163441	32	SLD 3.5/90/32 F BK	163464	32	SLD 3.5V/90/32 BK	164269
34	SLD 3.5/90/34 G BK	163442	34	SLD 3.5/90/34 F BK	163465	34	SLD 3.5V/90/34 BK	169923
36	SLD 3.5/90/36 G BK	163443	36	SLD 3.5/90/36 F BK	163466	36	SLD 3.5V/90/36 BK	164270
38	SLD 3.5/90/38 G BK	163444	38	SLD 3.5/90/38 F BK	163467	38	SLD 3.5V/90/38 BK	169924
40	SLD 3.5/90/40 G BK	163445	40	SLD 3.5/90/40 F BK	163468	40	SLD 3.5V/90/40 BK	164271
42	SLD 3.5/90/42 G BK	163446	42	SLD 3.5/90/42 F BK	163469	42	SLD 3.5V/90/42 BK	169925
44	SLD 3.5/90/44 G BK	163447	44	SLD 3.5/90/44 F BK	163470	44	SLD 3.5V/90/44 BK	164272
46	SLD 3.5/90/46 G BK	163448	46	SLD 3.5/90/46 F BK	163471	46	SLD 3.5V/90/46 BK	169926
48	SLD 3.5/90/48 G BK	163449	48	SLD 3.5/90/48 F BK	163472	48	SLD 3.5V/90/48 BK	164273

Notes: Plugs and headers are supplied with black moldings. Alternate colors are available upon request.
 Standard solder pin length is 4.5 mm. Other lengths are available upon request.
 See pages 6/76-80 for accessories.

SLD 3.50V/90 G
Double-Level Recessed
90° Orientation
Closed End
Non-locking

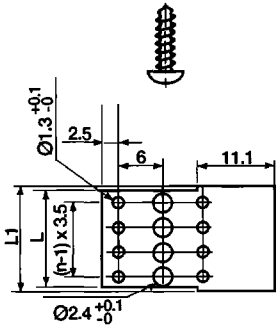
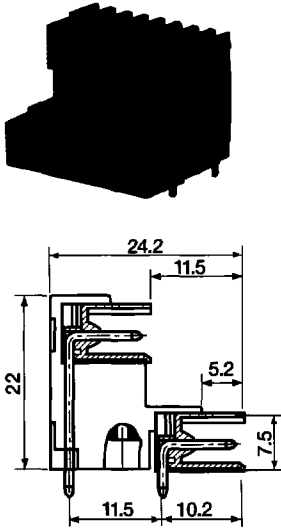

$L = n \times 3.5$
 $L1 = n \times 3.5 + 1.4$

SLD 3.50V/90 F
Double-Level Recessed
90° Orientation
Closed End
Locking

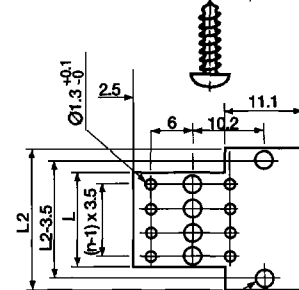
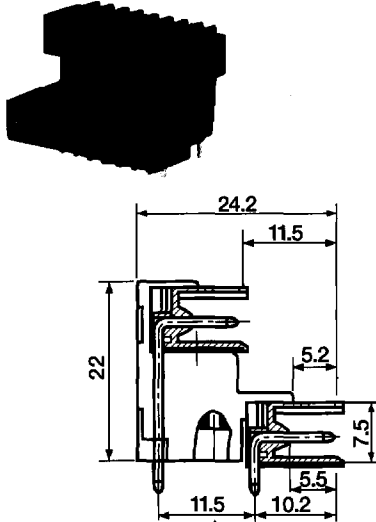

$L = n \times 3.5$
 $L2 = (n + 2) \times 3.5$

Mounting Foot Layout Measurements for
SLD 3.50/90
SLD 3.50/90 G
SLD 3.50/90 F

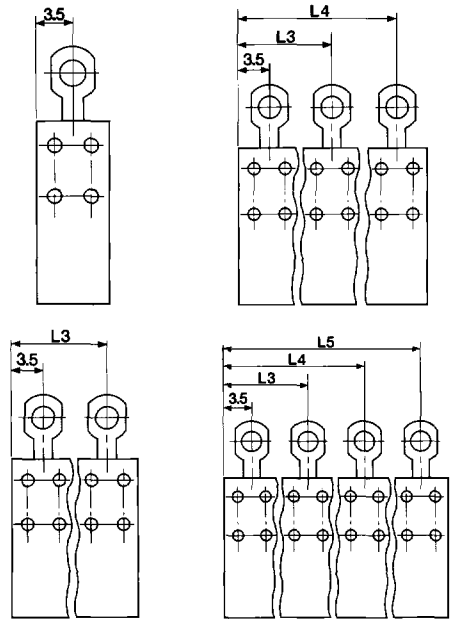

						Number of		Length (mounting foot)		
4	SLD 3.5V/90/4 G BK	164286	4	SLD 3.5V/90/4 F BK	164310	4	1			
6	SLD 3.5V/90/6 G BK	169927	6	SLD 3.5V/90/6 F BK	169938	6	1			
8	SLD 3.5V/90/8 G BK	164287	8	SLD 3.5V/90/8 F BK	164311	8	2	10.5		
10	SLD 3.5V/90/10 G BK	169928	10	SLD 3.5V/90/10 F BK	169939	10	2	14		
12	SLD 3.5V/90/12 G BK	164288	12	SLD 3.5V/90/12 F BK	164312	12	2	17.5		
14	SLD 3.5V/90/14 G BK	169929	14	SLD 3.5V/90/14 F BK	169940	14	2	21		
16	SLD 3.5V/90/16 G BK	164289	16	SLD 3.5V/90/16 F BK	164313	16	2	24.5		
18	SLD 3.5V/90/18 G BK	169930	18	SLD 3.5V/90/18 F BK	169941	18	3	14	28	
20	SLD 3.5V/90/20 G BK	164290	20	SLD 3.5V/90/20 F BK	164314	20	3	17.5	31.5	
22	SLD 3.5V/90/22 G BK	169931	22	SLD 3.5V/90/22 F BK	169942	22	3	17.5	35	
24	SLD 3.5V/90/24 G BK	164291	24	SLD 3.5V/90/24 F BK	164315	24	3	21	38.5	
26	SLD 3.5V/90/26 G BK	169932	26	SLD 3.5V/90/26 F BK	169943	26	3	21	42	
28	SLD 3.5V/90/28 G BK	164292	28	SLD 3.5V/90/28 F BK	164316	28	3	24.5	45.5	
30	SLD 3.5V/90/30 G BK	169933	30	SLD 3.5V/90/30 F BK	169944	30	3	24.5	49	
32	SLD 3.5V/90/32 G BK	164293	32	SLD 3.5V/90/32 F BK	164317	32	3	28	52.5	
34	SLD 3.5V/90/34 G BK	169934	34	SLD 3.5V/90/34 F BK	169945	34	4	21	38.5	56
36	SLD 3.5V/90/36 G BK	164294	36	SLD 3.5V/90/36 F BK	164318	36	4	21	42	59.5
38	SLD 3.5V/90/38 G BK	169935	38	SLD 3.5V/90/38 F BK	169946	38	4	24.5	42	63
40	SLD 3.5V/90/40 G BK	164295	40	SLD 3.5V/90/40 F BK	164319	40	4	24.5	45.5	66.5
42	SLD 3.5V/90/42 G BK	169936	42	SLD 3.5V/90/42 F BK	169947	42	4	24.5	49	70
44	SLD 3.5V/90/44 G BK	164296	44	SLD 3.5V/90/44 F BK	164320	44	4	28	49	73.5
46	SLD 3.5V/90/46 G BK	169937	46	SLD 3.5V/90/46 F BK	169948	46	4	28	52.5	77
48	SLD 3.5V/90/48 G BK	164297	48	SLD 3.5V/90/48 F BK	164321	48	4	28	56	80.5

Notes: Plugs and headers are supplied with black moldings. Alternate colors are available upon request.
 Standard solder pin length is 4.5 mm. Other lengths are available upon request.
 See pages 6/76-80 for accessories.

Printed Circuit Board Connectors

BL/SL 3.50 Series
3.50 mm Pitch Headers

SLD 3.50V/180
Double-Level Recessed
180° Orientation
Open End
Non-locking

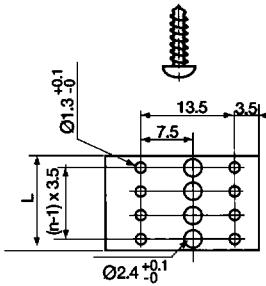
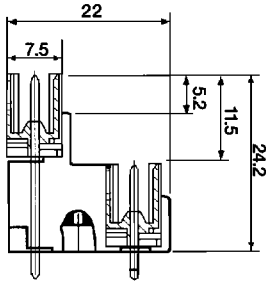

$L = n \times 3.5$

SLD 3.50V/180 G
Double-Level Recessed
180° Orientation
Closed End
Non-locking

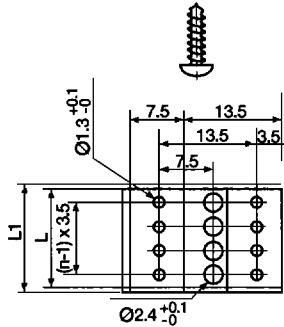
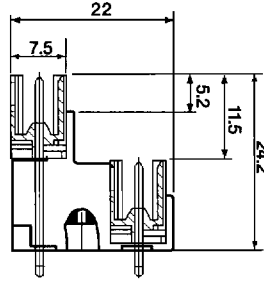

$L = n \times 3.5$
 $L1 = n \times 3.5 + 1.4$

SLD 3.50V/180 F
Double-Level Recessed
180° Orientation
Closed End
Locking

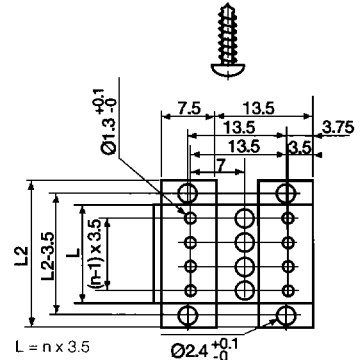
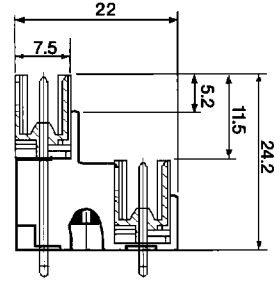
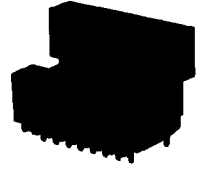

$L = n \times 3.5$
 $L2 = (n + 2) \times 3.5$

Pin No.	Type	Part No.	Pin No.	Type	Part No.	Pin No.	Type	Part No.
4	SLD 3.5V/180/4 BK	164149	4	SLD 3.5V/180/4 G BK	164173	4	SLD 3.5V/180/4 F BK	164197
6	SLD 3.5V/180/6 BK	169884	6	SLD 3.5V/180/6 G BK	169895	6	SLD 3.5V/180/6 F BK	169906
8	SLD 3.5V/180/8 BK	164150	8	SLD 3.5V/180/8 G BK	164174	8	SLD 3.5V/180/8 F BK	164198
10	SLD 3.5V/180/10 BK	169885	10	SLD 3.5V/180/10 G BK	169896	10	SLD 3.5V/180/10 F BK	169907
12	SLD 3.5V/180/12 BK	164151	12	SLD 3.5V/180/12 G BK	164175	12	SLD 3.5V/180/12 F BK	164199
14	SLD 3.5V/180/14 BK	169886	14	SLD 3.5V/180/14 G BK	169897	14	SLD 3.5V/180/14 F BK	169908
16	SLD 3.5V/180/16 BK	164152	16	SLD 3.5V/180/16 G BK	164176	16	SLD 3.5V/180/16 F BK	164200
18	SLD 3.5V/180/18 BK	169887	18	SLD 3.5V/180/18 G BK	169898	18	SLD 3.5V/180/18 F BK	168453
20	SLD 3.5V/180/20 BK	164453	20	SLD 3.5V/180/20 G BK	164177	20	SLD 3.5V/180/20 F BK	164201
22	SLD 3.5V/180/22 BK	169888	22	SLD 3.5V/180/22 G BK	169899	22	SLD 3.5V/180/22 F BK	169909
24	SLD 3.5V/180/24 BK	164154	24	SLD 3.5V/180/24 G BK	164178	24	SLD 3.5V/180/24 F BK	164202
26	SLD 3.5V/180/26 BK	169889	26	SLD 3.5V/180/26 G BK	169900	26	SLD 3.5V/180/26 F BK	169910
28	SLD 3.5V/180/28 BK	164155	28	SLD 3.5V/180/28 G BK	164179	28	SLD 3.5V/180/28 F BK	164203
30	SLD 3.5V/180/30 BK	169890	30	SLD 3.5V/180/30 G BK	169901	30	SLD 3.5V/180/30 F BK	169911
32	SLD 3.5V/180/32 BK	164156	32	SLD 3.5V/180/32 G BK	164180	32	SLD 3.5V/180/32 F BK	164204
34	SLD 3.5V/180/34 BK	169891	34	SLD 3.5V/180/34 G BK	169902	34	SLD 3.5V/180/34 F BK	169912
36	SLD 3.5V/180/36 BK	164157	36	SLD 3.5V/180/36 G BK	164181	36	SLD 3.5V/180/36 F BK	164205
38	SLD 3.5V/180/38 BK	169892	38	SLD 3.5V/180/38 G BK	169903	38	SLD 3.5V/180/38 F BK	169913
40	SLD 3.5V/180/40 BK	164158	40	SLD 3.5V/180/40 G BK	164182	40	SLD 3.5V/180/40 F BK	164206
42	SLD 3.5V/180/42 BK	169893	42	SLD 3.5V/180/42 G BK	169904	42	SLD 3.5V/180/42 F BK	169914
44	SLD 3.5V/180/44 BK	164159	44	SLD 3.5V/180/44 G BK	164183	44	SLD 3.5V/180/44 F BK	164207
46	SLD 3.5V/180/46 BK	169894	46	SLD 3.5V/180/46 G BK	169905	46	SLD 3.5V/180/46 F BK	169915
48	SLD 3.5V/180/48 BK	164160	48	SLD 3.5V/180/48 G BK	164184	48	SLD 3.5V/180/48 F BK	164208

Notes: Plugs and headers are supplied with black moldings. Alternate colors are available upon request. Standard solder pin length is 4.5 mm. Other lengths are available upon request. See pages 6/76-80 for accessories.

Printed Circuit Board Connectors

BLZ/SL Series
5.00 mm Pitch Plugs

BLZ 5.00
180° Orientation
Non-Locking
Screw Clamp

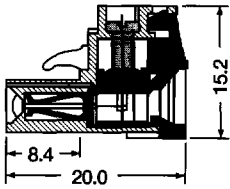
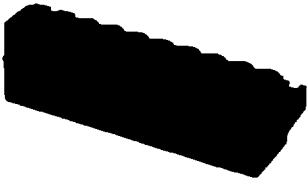

BLZ 5.00 B
180° Orientation
Locking*
Screw Clamp

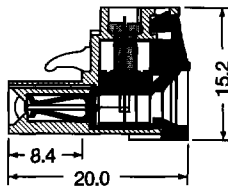
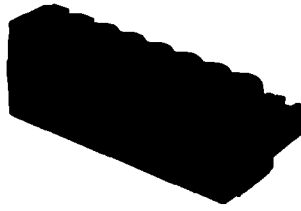

BLZ 5.00/90
90° Orientation
Non-Locking
Screw Clamp

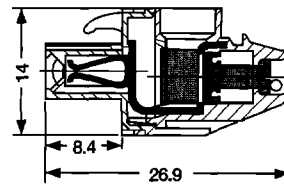

Poles	Type	Part No.	Poles	Type	Part No.	Poles	Type	Part No.
2	BLZ 5.00/2 BK	162561	2	BLZ 5.00/2 B BK	162576	2	BLZ 5.00/90/2 BK	163689
3	BLZ 5.00/3 BK	162562	3	BLZ 5.00/3 B BK	162577	3	BLZ 5.00/90/3 BK	163690
4	BLZ 5.00/4 BK	159608	4	BLZ 5.00/4 B BK	162578	4	BLZ 5.00/90/4 BK	163691
5	BLZ 5.00/5 BK	162563	5	BLZ 5.00/5 B BK	162579	5	BLZ 5.00/90/5 BK	163692
6	BLZ 5.00/6 BK	159609	6	BLZ 5.00/6 B BK	162580	6	BLZ 5.00/90/6 BK	163693
7	BLZ 5.00/7 BK	159610	7	BLZ 5.00/7 B BK	162581	7	BLZ 5.00/90/7 BK	163694
8	BLZ 5.00/8 BK	159611	8	BLZ 5.00/8 B BK	162582	8	BLZ 5.00/90/8 BK	163695
9	BLZ 5.00/9 BK	162564	9	BLZ 5.00/9 B BK	162583	9	BLZ 5.00/90/9 BK	163696
10	BLZ 5.00/10 BK	159612	10	BLZ 5.00/10 B BK	162584	10	BLZ 5.00/90/10 BK	163697
11	BLZ 5.00/11 BK	162565	11	BLZ 5.00/11 B BK	162585	11	BLZ 5.00/90/11 BK	163698
12	BLZ 5.00/12 BK	160299	12	BLZ 5.00/12 B BK	162586	12	BLZ 5.00/90/12 BK	163699
13	BLZ 5.00/13 BK	162566	13	BLZ 5.00/13 B BK	162587	13	BLZ 5.00/90/13 BK	163700
14	BLZ 5.00/14 BK	162567	14	BLZ 5.00/14 B BK	162588	14	BLZ 5.00/90/14 BK	163701
15	BLZ 5.00/15 BK	162568	15	BLZ 5.00/15 B BK	162589	15	BLZ 5.00/90/15 BK	163702
16	BLZ 5.00/16 BK	160330	16	BLZ 5.00/16 B BK	162590	16	BLZ 5.00/90/16 BK	163703
17	BLZ 5.00/17 BK	162569	17	BLZ 5.00/17 B BK	162591	17	BLZ 5.00/90/17 BK	163704
18	BLZ 5.00/18 BK	162570	18	BLZ 5.00/18 B BK	162592	18	BLZ 5.00/90/18 BK	163705
19	BLZ 5.00/19 BK	162571	19	BLZ 5.00/19 B BK	162593	19	BLZ 5.00/90/19 BK	163706
20	BLZ 5.00/20 BK	162572	20	BLZ 5.00/20 B BK	162594	20	BLZ 5.00/90/20 BK	163707
21	BLZ 5.00/21 BK	162573	21	BLZ 5.00/21 B BK	162595	21	BLZ 5.00/90/21 BK	163708
22	BLZ 5.00/22 BK	162574	22	BLZ 5.00/22 B BK	162596	22	BLZ 5.00/90/22 BK	163709
23	BLZ 5.00/23 BK	162575	23	BLZ 5.00/23 B BK	162597	23	BLZ 5.00/90/23 BK	163710
24	BLZ 5.00/24 BK	161147	24	BLZ 5.00/24 B BK	162598	24	BLZ 5.00/90/24 BK	163711

Notes: Plugs and headers are supplied with black moldings. Alternate colors are available upon request.
Standard solder pin length is 4.5 mm. Other lengths are available upon request.
See pages 6/76-80 for accessories.

Printed Circuit Board Connectors

BLZ/SL Series
5.00 mm Pitch Plugs

BLZ 5.00/90 B
90° orientation
Locking*
Screw Clamp

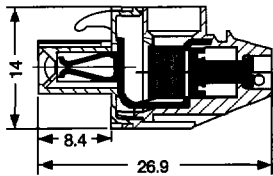

BLZ 5.00/270
270° Plug
Non-Locking
Screw Clamp

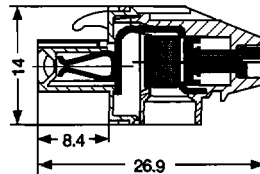

BLZ 5.00/270 B
270° Orientation
Locking*
Screw Clamp

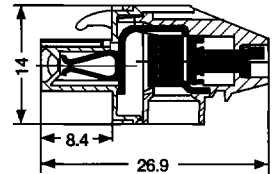
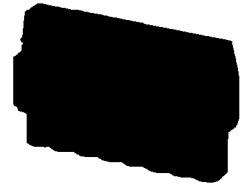

2	BLZ 5.00/90/2 B BK	163735	2	BLZ 5.00/270/2 BK	163781	2	BLZ 5.00/270/2 B BK	163827
3	BLZ 5.00/90/3 B BK	163736	3	BLZ 5.00/270/3 BK	163782	3	BLZ 5.00/270/3 B BK	163828
4	BLZ 5.00/90/4 B BK	163737	4	BLZ 5.00/270/4 BK	163783	4	BLZ 5.00/270/4 B BK	163829
5	BLZ 5.00/90/5 B BK	163738	5	BLZ 5.00/270/5 BK	163784	5	BLZ 5.00/270/5 B BK	163830
6	BLZ 5.00/90/6 B BK	163739	6	BLZ 5.00/270/6 BK	163785	6	BLZ 5.00/270/6 B BK	163831
7	BLZ 5.00/90/7 B BK	163740	7	BLZ 5.00/270/7 BK	163786	7	BLZ 5.00/270/7 B BK	163832
8	BLZ 5.00/90/8 B BK	163741	8	BLZ 5.00/270/8 BK	163787	8	BLZ 5.00/270/8 B BK	163833
9	BLZ 5.00/90/9 B BK	163742	9	BLZ 5.00/270/9 BK	163788	9	BLZ 5.00/270/9 B BK	163834
10	BLZ 5.00/90/10 B BK	163743	10	BLZ 5.00/270/10 BK	163789	10	BLZ 5.00/270/10 B BK	163835
11	BLZ 5.00/90/11 B BK	163744	11	BLZ 5.00/270/11 BK	163790	11	BLZ 5.00/270/11 B BK	163836
12	BLZ 5.00/90/12 B BK	163745	12	BLZ 5.00/270/12 BK	163791	12	BLZ 5.00/270/12 B BK	163837
13	BLZ 5.00/90/13 B BK	163746	13	BLZ 5.00/270/13 BK	163792	13	BLZ 5.00/270/13 B BK	163838
14	BLZ 5.00/90/14 B BK	163747	14	BLZ 5.00/270/14 BK	163793	14	BLZ 5.00/270/14 B BK	163839
15	BLZ 5.00/90/15 B BK	163748	15	BLZ 5.00/270/15 BK	163794	15	BLZ 5.00/270/15 B BK	163840
16	BLZ 5.00/90/16 B BK	163749	16	BLZ 5.00/270/16 BK	163795	16	BLZ 5.00/270/16 B BK	163841
17	BLZ 5.00/90/17 B BK	163750	17	BLZ 5.00/270/17 BK	163796	17	BLZ 5.00/270/17 B BK	163842
18	BLZ 5.00/90/18 B BK	163751	18	BLZ 5.00/270/18 BK	163797	18	BLZ 5.00/270/18 B BK	163843
19	BLZ 5.00/90/19 B BK	163752	19	BLZ 5.00/270/19 BK	163798	19	BLZ 5.00/270/19 B BK	163844
20	BLZ 5.00/90/20 B BK	163753	20	BLZ 5.00/270/20 BK	163799	20	BLZ 5.00/270/20 B BK	163845
21	BLZ 5.00/90/21 B BK	163754	21	BLZ 5.00/270/21 BK	163800	21	BLZ 5.00/270/21 B BK	163846
22	BLZ 5.00/90/22 B BK	163755	22	BLZ 5.00/270/22 BK	163801	22	BLZ 5.00/270/22 B BK	163847
23	BLZ 5.00/90/23 B BK	163756	23	BLZ 5.00/270/23 BK	163802	23	BLZ 5.00/270/23 B BK	163848
24	BLZ 5.00/90/24 B BK	163757	24	BLZ 5.00/270/24 BK	163803	24	BLZ 5.00/270/24 B BK	163849

Note: Plugs and headers are supplied with black moldings. Alternate colors are available upon request.
* See pages 6/76-80 for locking blocks and other accessories.

BLZF 5.00
180° Orientation
Non-Locking
Tension Clamp

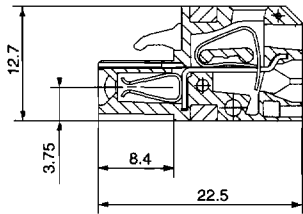

2	BLZF 5.00/2 BK	169660		
3	BLZF 5.00/3 BK	169661		
4	BLZF 5.00/4 BK	169662		
5	BLZF 5.00/5 BK	169663		
6	BLZF 5.00/6 BK	169664		
7	BLZF 5.00/7 BK	169665		
8	BLZF 5.00/8 BK	169666		
9	BLZF 5.00/9 BK	169667		
10	BLZF 5.00/10 BK	169668		
11	BLZF 5.00/11 BK	169669		
12	BLZF 5.00/12 BK	169670		
13	BLZF 5.00/13 BK	169671		
14	BLZF 5.00/14 BK	169672		
15	BLZF 5.00/15 BK	169673		
16	BLZF 5.00/16 BK	169674		
17	BLZF 5.00/17 BK	169675		
18	BLZF 5.00/18 BK	169676		
19	BLZF 5.00/19 BK	169677		
20	BLZF 5.00/20 BK	169678		
21	BLZF 5.00/21 BK	169679		
22	BLZF 5.00/22 BK	169680		
23	BLZF 5.00/23 BK	169681		
24	BLZF 5.00/24 BK	169682		

Note: Plugs and headers are supplied with black moldings. Alternate colors are available upon request.
 See pages 6/76-80 for accessories.

Printed Circuit Board Connectors

BLZ/SL Series
5.00 mm Pitch Headers

SL 5.00/90
Single-Level
90° Orientation
Open End
Non-Locking

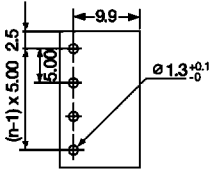
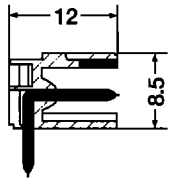

SL 5.00/90 B
Single-Level
90° Orientation
Closed End
Locking*

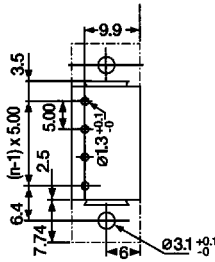
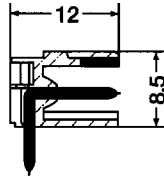

SL 5.00/135
Single-Level
135° Orientation
Open End
Non-Locking

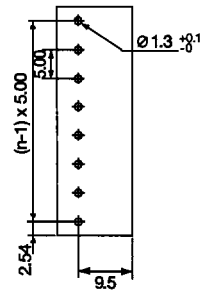
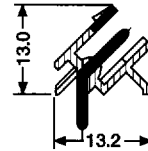

2	SL 5.00/90/2 BK	162599	2	SL 5.00/90/2 B BK	162621	2	SL 5.00/135/2 BK	163082
3	SL 5.00/90/3 BK	162600	3	SL 5.00/90/3 B BK	162622	3	SL 5.00/135/3 BK	163083
4	SL 5.00/90/4 BK	162601	4	SL 5.00/90/4 B BK	159615	4	SL 5.00/135/4 BK	163084
5	SL 5.00/90/5 BK	162602	5	SL 5.00/90/5 B BK	162623	5	SL 5.00/135/5 BK	163085
6	SL 5.00/90/6 BK	159618	6	SL 5.00/90/6 B BK	162624	6	SL 5.00/135/6 BK	163086
7	SL 5.00/90/7 BK	162603	7	SL 5.00/90/7 B BK	159616	7	SL 5.00/135/7 BK	163087
8	SL 5.00/90/8 BK	162604	8	SL 5.00/90/8 B BK	162625	8	SL 5.00/135/8 BK	163088
9	SL 5.00/90/9 BK	162605	9	SL 5.00/90/9 B BK	162626	9	SL 5.00/135/9 BK	163089
10	SL 5.00/90/10 BK	162606	10	SL 5.00/90/10 B BK	159617	10	SL 5.00/135/10 BK	163090
11	SL 5.00/90/11 BK	162607	11	SL 5.00/90/11 B BK	162627	11	SL 5.00/135/11 BK	163091
12	SL 5.00/90/12 BK	162608	12	SL 5.00/90/12 B BK	160332	12	SL 5.00/135/12 BK	163092
13	SL 5.00/90/13 BK	162609	13	SL 5.00/90/13 B BK	162628	13	SL 5.00/135/13 BK	163093
14	SL 5.00/90/14 BK	162610	14	SL 5.00/90/14 B BK	162629	14	SL 5.00/135/14 BK	163094
15	SL 5.00/90/15 BK	162611	15	SL 5.00/90/15 B BK	162630	15	SL 5.00/135/15 BK	163095
16	SL 5.00/90/16 BK	162612	16	SL 5.00/90/16 B BK	160333	16	SL 5.00/135/16 BK	163096
17	SL 5.00/90/17 BK	162613	17	SL 5.00/90/17 B BK	162631	17	SL 5.00/135/17 BK	163097
18	SL 5.00/90/18 BK	162614	18	SL 5.00/90/18 B BK	162632	18	SL 5.00/135/18 BK	163098
19	SL 5.00/90/19 BK	162615	19	SL 5.00/90/19 B BK	162633	19	SL 5.00/135/19 BK	163099
20	SL 5.00/90/20 BK	162616	20	SL 5.00/90/20 B BK	162634	20	SL 5.00/135/20 BK	163100
21	SL 5.00/90/21 BK	162617	21	SL 5.00/90/21 B BK	162635	21	SL 5.00/135/21 BK	163101
22	SL 5.00/90/22 BK	162618	22	SL 5.00/90/22 B BK	162636	22	SL 5.00/135/22 BK	163102
23	SL 5.00/90/23 BK	162619	23	SL 5.00/90/23 B BK	162637	23	SL 5.00/135/23 BK	163103
24	SL 5.00/90/24 BK	162620	24	SL 5.00/90/24 B BK	162638	24	SL 5.00/135/24 BK	163104

Note: Plugs and headers are supplied with black moldings. Alternate colors are available upon request.
 Standard pin length is 4.5 mm. Other lengths are available upon request.
 *See pages 6/76-80 for locking blocks and other accessories.

SL 5.00/135 B
Single-Level
135° Orientation
Closed End
Locking*

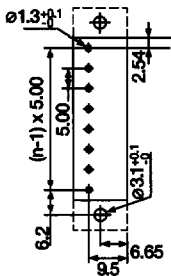
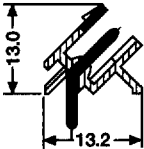
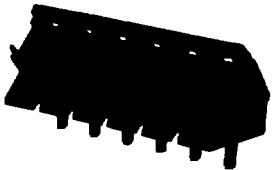

SL 5.00/180
Single-Level
180° Orientation
Open End
Non-Locking

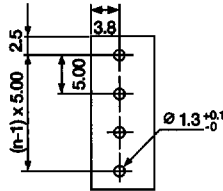
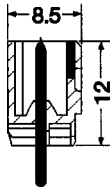

SL 5.00/180 B
Single-Level
180° Orientation
Closed End
Locking*

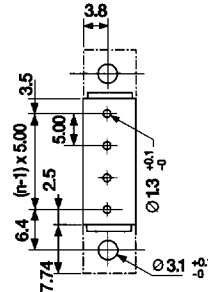
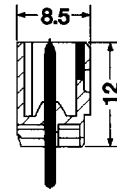

2	SL 5.00/135/2 B BK	163105	2	SL 5.00/180/2 BK	162639	2	SL 5.00/180/2 B BK	162662
3	SL 5.00/135/3 B BK	163106	3	SL 5.00/180/3 BK	162640	3	SL 5.00/180/3 B BK	162663
4	SL 5.00/135/4 B BK	163107	4	SL 5.00/180/4 BK	162641	4	SL 5.00/180/4 B BK	159613
5	SL 5.00/135/5 B BK	163108	5	SL 5.00/180/5 BK	162642	5	SL 5.00/180/5 B BK	162664
6	SL 5.00/135/6 B BK	163109	6	SL 5.00/180/6 BK	162643	6	SL 5.00/180/6 B BK	162665
7	SL 5.00/135/7 B BK	163110	7	SL 5.00/180/7 BK	162644	7	SL 5.00/180/7 B BK	162666
8	SL 5.00/135/8 B BK	163111	8	SL 5.00/180/8 BK	162645	8	SL 5.00/180/8 B BK	159614
9	SL 5.00/135/9 B BK	163112	9	SL 5.00/180/9 BK	162646	9	SL 5.00/180/9 B BK	162667
10	SL 5.00/135/10 B BK	163113	10	SL 5.00/180/10 BK	162647	10	SL 5.00/180/10 B BK	162668
11	SL 5.00/135/11 B BK	163114	11	SL 5.00/180/11 BK	162648	11	SL 5.00/180/11 B BK	162669
12	SL 5.00/135/12 B BK	163115	12	SL 5.00/180/12 BK	162649	12	SL 5.00/180/12 B BK	160331
13	SL 5.00/135/13 B BK	163116	13	SL 5.00/180/13 BK	162650	13	SL 5.00/180/13 B BK	162670
14	SL 5.00/135/14 B BK	163117	14	SL 5.00/180/14 BK	162651	14	SL 5.00/180/14 B BK	162671
15	SL 5.00/135/15 B BK	163118	15	SL 5.00/180/15 BK	162652	15	SL 5.00/180/15 B BK	162672
16	SL 5.00/135/16 B BK	163119	16	SL 5.00/180/16 BK	162653	16	SL 5.00/180/16 B BK	162673
17	SL 5.00/135/17 B BK	163120	17	SL 5.00/180/17 BK	162654	17	SL 5.00/180/17 B BK	162674
18	SL 5.00/135/18 B BK	163121	18	SL 5.00/180/18 BK	162655	18	SL 5.00/180/18 B BK	162675
19	SL 5.00/135/19 B BK	163122	19	SL 5.00/180/19 BK	162656	19	SL 5.00/180/19 B BK	162676
20	SL 5.00/135/20 B BK	163123	20	SL 5.00/180/20 BK	162657	20	SL 5.00/180/20 B BK	162677
21	SL 5.00/135/21 B BK	163124	21	SL 5.00/180/21 BK	162658	21	SL 5.00/180/21 B BK	162678
22	SL 5.00/135/22 B BK	163125	22	SL 5.00/180/22 BK	162659	22	SL 5.00/180/22 B BK	162679
23	SL 5.00/135/23 B BK	163126	23	SL 5.00/180/23 BK	162660	23	SL 5.00/180/23 B BK	162680
24	SL 5.00/135/24 B BK	163127	24	SL 5.00/180/24 BK	162661	24	SL 5.00/180/24 B BK	162681

Notes: Plugs and headers are supplied with black moldings. Alternate colors are available upon request.
 Standard solder pin length is 4.5 mm. Other lengths are available upon request.
 *See pages 6/76-80 for locking blocks and other accessories.

Printed Circuit Board Connectors

BLZ/SL Series

5.00 mm Pitch Headers

SLD 5.00R/90
Double-Level
90° Orientation
Closed End
Non-Locking

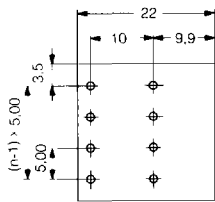
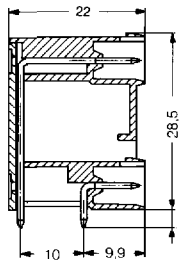
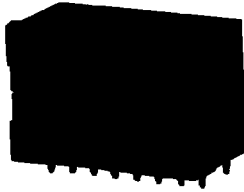

SLD 5.00R/180
Double-Level
180° Orientation
Closed End
Non-Locking

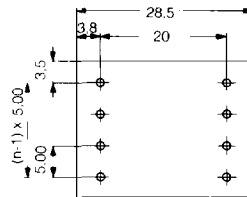
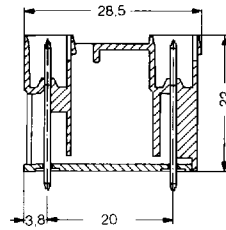
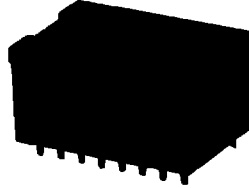

Poles	Type	Part No.	Poles	Type	Part No.
4	SLD 5.00R/90/4 BK	1653700010	4	SLD 5.00R/180/4 BK	1653470010
6	SLD 5.00R/90/6 BK	1653710010	6	SLD 5.00R/180/6 BK	1653480010
8	SLD 5.00R/90/8 BK	1653720010	8	SLD 5.00R/180/8 BK	1653490010
10	SLD 5.00R/90/10 BK	1653730010	10	SLD 5.00R/180/10 BK	1653500010
12	SLD 5.00R/90/12 BK	1653740010	12	SLD 5.00R/180/12 BK	1653510010
14	SLD 5.00R/90/14 BK	1653750010	14	SLD 5.00R/180/14 BK	1653520010
16	SLD 5.00R/90/16 BK	1653760010	16	SLD 5.00R/180/16 BK	1653530010
18	SLD 5.00R/90/18 BK	1653770010	18	SLD 5.00R/180/18 BK	1653540010
20	SLD 5.00R/90/20 BK	1653780010	20	SLD 5.00R/180/20 BK	1653550010
22	SLD 5.00R/90/22 BK	1653790010	22	SLD 5.00R/180/22 BK	1653560010
24	SLD 5.00R/90/24 BK	1653800010	24	SLD 5.00R/180/24 BK	1653570010
26	SLD 5.00R/90/26 BK	1653810010	26	SLD 5.00R/180/26 BK	1653580010
28	SLD 5.00R/90/28 BK	1653820010	28	SLD 5.00R/180/28 BK	1653590010
30	SLD 5.00R/90/30 BK	1653830010	30	SLD 5.00R/180/30 BK	1653600010
32	SLD 5.00R/90/32 BK	1653840010	32	SLD 5.00R/180/32 BK	1653610010
34	SLD 5.00R/90/34 BK	1653850010	34	SLD 5.00R/180/34 BK	1653620010
36	SLD 5.00R/90/36 BK	1653860010	36	SLD 5.00R/180/36 BK	1653630010
38	SLD 5.00R/90/38 BK	1653870010	38	SLD 5.00R/180/38 BK	1653640010
40	SLD 5.00R/90/40 BK	1653880010	40	SLD 5.00R/180/40 BK	1653650010
42	SLD 5.00R/90/42 BK	1653890010	42	SLD 5.00R/180/42 BK	1653660010
44	SLD 5.00R/90/44 BK	1653900010	44	SLD 5.00R/180/44 BK	1653670010
46	SLD 5.00R/90/46 BK	1653910010	46	SLD 5.00R/180/46 BK	1653680010
48	SLD 5.00R/90/48 BK	1653920010	48	SLD 5.00R/180/48 BK	1653690010

Notes: Plugs and headers are supplied with black moldings. Alternate colors are available upon request. Standard solder pin length is 4.5 mm. Other lengths are available upon request. See pages 6/76-80 for accessories.

Printed Circuit Board Connectors

BLZ/SL Series
5.08 mm Pitch Headers

BLZ 5.08
180° Orientation
Non-Locking
Screw Clamp

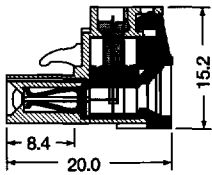
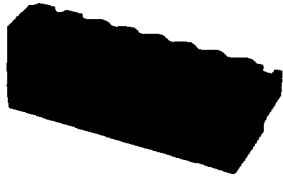

BLZ 5.08 B
180° Orientation
Locking*
Screw Clamp

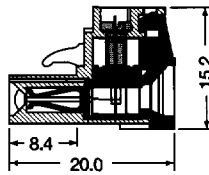
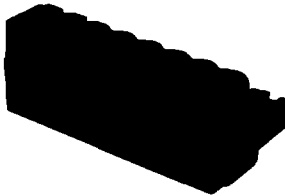

BLZ 5.08/90
90° Orientation
Non-Locking
Screw Clamp

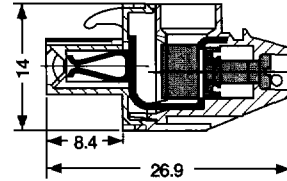

Poles	Type	Part No. orange	black	Poles	Type	Part No. orange	black	Poles	Type	Part No. orange	black
2	BLZ 5.08/2	152646	152641	2	BLZ 5.08/2 B	152876	152871	2	BLZ 5.08/90/2	155276	155271
3	BLZ 5.08/3	152656	152651	3	BLZ 5.08/3 B	152886	152881	3	BLZ 5.08/90/3	155286	155281
4	BLZ 5.08/4	152666	152661	4	BLZ 5.08/4 B	152896	152891	4	BLZ 5.08/90/4	155296	155291
5	BLZ 5.08/5	152676	152671	5	BLZ 5.08/5 B	152906	152901	5	BLZ 5.08/90/5	155306	155301
6	BLZ 5.08/6	152686	152681	6	BLZ 5.08/6 B	152916	152911	6	BLZ 5.08/90/6	155316	155311
7	BLZ 5.08/7	152696	152691	7	BLZ 5.08/7 B	152926	152921	7	BLZ 5.08/90/7	155326	155321
8	BLZ 5.08/8	152706	152701	8	BLZ 5.08/8 B	152936	152931	8	BLZ 5.08/90/8	155336	155331
9	BLZ 5.08/9	152716	152711	9	BLZ 5.08/9 B	152946	152941	9	BLZ 5.08/90/9	155346	155341
10	BLZ 5.08/10	152726	152721	10	BLZ 5.08/10 B	152956	152951	10	BLZ 5.08/90/10	155356	155351
11	BLZ 5.08/11	152736	152731	11	BLZ 5.08/11 B	152966	152961	11	BLZ 5.08/90/11	155366	155361
12	BLZ 5.08/12	152746	152741	12	BLZ 5.08/12 B	152976	152971	12	BLZ 5.08/90/12	155376	155371
13	BLZ 5.08/13	152756	152751	13	BLZ 5.08/13 B	152986	152981	13	BLZ 5.08/90/13	155386	155381
14	BLZ 5.08/14	152766	152761	14	BLZ 5.08/14 B	152996	152991	14	BLZ 5.08/90/14	155396	155391
15	BLZ 5.08/15	152776	152771	15	BLZ 5.08/15 B	153006	153001	15	BLZ 5.08/90/15	155406	155401
16	BLZ 5.08/16	152786	152781	16	BLZ 5.08/16 B	153016	153011	16	BLZ 5.08/90/16	155416	155411
17	BLZ 5.08/17	152796	152791	17	BLZ 5.08/17 B	153026	153021	17	BLZ 5.08/90/17	155426	155421
18	BLZ 5.08/18	152806	152801	18	BLZ 5.08/18 B	153036	153031	18	BLZ 5.08/90/18	155436	155431
19	BLZ 5.08/19	152816	152811	19	BLZ 5.08/19 B	153046	153041	19	BLZ 5.08/90/19	155446	155441
20	BLZ 5.08/20	152826	152821	20	BLZ 5.08/20 B	153056	153051	20	BLZ 5.08/90/20	155456	155451
21	BLZ 5.08/21	152836	152831	21	BLZ 5.08/21 B	153066	153061	21	BLZ 5.08/90/21	155466	155461
22	BLZ 5.08/22	152846	152841	22	BLZ 5.08/22 B	153076	153071	22	BLZ 5.08/90/22	155476	155471
23	BLZ 5.08/23	152856	152851	23	BLZ 5.08/23 B	153086	153081	23	BLZ 5.08/90/23	155486	155481
24	BLZ 5.08/24	152866	152861	24	BLZ 5.08/24 B	153096	153091	24	BLZ 5.08/90/24	155496	155491

Note: Plugs and headers are supplied with black moldings. Alternate colors are available upon request.
Standard solder pin length is 4.5 mm. Other lengths are available upon request.
*See pages 6/76-80 for locking blocks and other accessories.

Printed Circuit Board Connectors

BLZ/SL Series
5.08 mm Pitch Plugs

BLZ 5.08/90 B
90° Orientation
Locking*
Screw Clamp

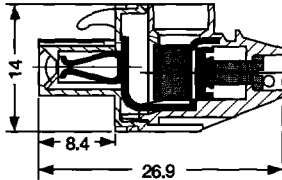

BLZ 5.08/270
270° Orientation
Non-Locking
Screw Clamp

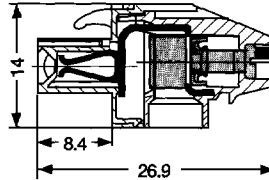

BLZ 5.08/270 B
270° Orientation
Locking*
Screw Clamp

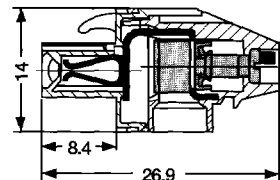
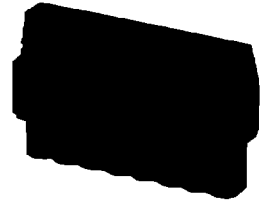

	Part No. orange	black	Poles	Type	Part No. orange	black	Poles	Type	Part No. orange	black	
2	BLZ 5.08/90/2 B	155506	155501	2	BLZ 5.08/270/2	155736	155731	2	BLZ 5.08/270/2 B	155966	155961
3	BLZ 5.08/90/3 B	155516	155511	3	BLZ 5.08/270/3	155746	155741	3	BLZ 5.08/270/3 B	155976	155971
4	BLZ 5.08/90/4 B	155526	155521	4	BLZ 5.08/270/4	155756	155751	4	BLZ 5.08/270/4 B	155986	155981
5	BLZ 5.08/90/5 B	155536	155531	5	BLZ 5.08/270/5	155766	155761	5	BLZ 5.08/270/5 B	155996	155991
6	BLZ 5.08/90/6 B	155546	155541	6	BLZ 5.08/270/6	155776	155771	6	BLZ 5.08/270/6 B	156006	156001
7	BLZ 5.08/90/7 B	155556	155551	7	BLZ 5.08/270/7	155786	155781	7	BLZ 5.08/270/7 B	156016	156011
8	BLZ 5.08/90/8 B	155566	155561	8	BLZ 5.08/270/8	155796	155791	8	BLZ 5.08/270/8 B	156026	156021
9	BLZ 5.08/90/9 B	155576	155571	9	BLZ 5.08/270/9	155806	155801	9	BLZ 5.08/270/9 B	156036	156031
10	BLZ 5.08/90/10 B	155586	155581	10	BLZ 5.08/270/10	155816	155811	10	BLZ 5.08/270/10 B	156046	156041
11	BLZ 5.08/90/11 B	155596	155591	11	BLZ 5.08/270/11	155826	155821	11	BLZ 5.08/270/11 B	156056	156051
12	BLZ 5.08/90/12 B	155606	155601	12	BLZ 5.08/270/12	155836	155831	12	BLZ 5.08/270/12 B	156066	156061
13	BLZ 5.08/90/13 B	155616	155611	13	BLZ 5.08/270/13	155846	155841	13	BLZ 5.08/270/13 B	156076	156071
14	BLZ 5.08/90/14 B	155626	155621	14	BLZ 5.08/270/14	155856	155851	14	BLZ 5.08/270/14 B	156086	156081
15	BLZ 5.08/90/15 B	155636	155631	15	BLZ 5.08/270/15	155866	155861	15	BLZ 5.08/270/15 B	156096	156091
16	BLZ 5.08/90/16 B	155646	155641	16	BLZ 5.08/270/16	155876	155871	16	BLZ 5.08/270/16 B	156106	156101
17	BLZ 5.08/90/17 B	155656	155651	17	BLZ 5.08/270/17	155886	155881	17	BLZ 5.08/270/17 B	156116	156111
18	BLZ 5.08/90/18 B	155666	155661	18	BLZ 5.08/270/18	155896	155891	18	BLZ 5.08/270/18 B	156126	156121
19	BLZ 5.08/90/19 B	155676	155671	19	BLZ 5.08/270/19	155906	155901	19	BLZ 5.08/270/19 B	156136	156131
20	BLZ 5.08/90/20 B	155686	155681	20	BLZ 5.08/270/20	155916	155911	20	BLZ 5.08/270/20 B	156146	156141
21	BLZ 5.08/90/21 B	155696	155691	21	BLZ 5.08/270/21	155926	155921	21	BLZ 5.08/270/21 B	156156	156151
22	BLZ 5.08/90/22 B	155706	155701	22	BLZ 5.08/270/22	155936	155931	22	BLZ 5.08/270/22 B	156166	156161
23	BLZ 5.08/90/23 B	155716	155711	23	BLZ 5.08/270/23	155946	155941	23	BLZ 5.08/270/23 B	156176	156171
24	BLZ 5.08/90/24 B	155726	155721	24	BLZ 5.08/270/24	155956	155951	24	BLZ 5.08/270/24 B	156186	156181

Note: Plugs are supplied with orange or black moldings. Alternate colors are available upon request.
*See pages 6/76-80 for locking blocks and other accessories.

BLT 5.08
Top Entry Orientation
Non-Locking
Screw Clamp

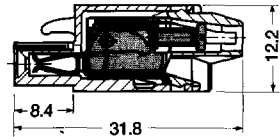

BLT 5.08 B
Top Entry Orientation
Locking*
Screw Clamp

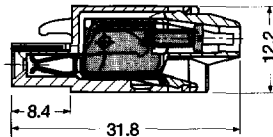

BLDT 5.08
Dual Plug
90° Orientation
Non-Locking
Screw Clamp

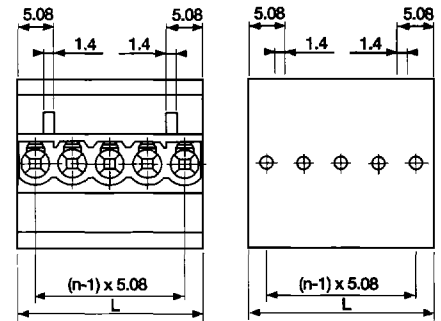
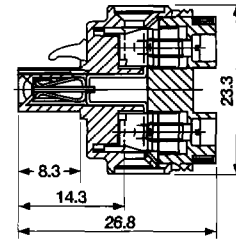
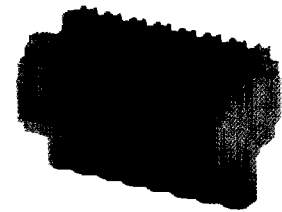

Poles	Type	Part No. orange	black	Poles	Type	Part No. orange	black	Poles	Type	164473	166071
2	BLT 5.08/2	149956	149951	2	BLT 5.08/2 B	150186	150181	2	BLDT 5.08/2	164473	166071
3	BLT 5.08/3	149966	149961	3	BLT 5.08/3 B	150196	150191	3	BLDT 5.08/3	164474	166072
4	BLT 5.08/4	149976	149971	4	BLT 5.08/4 B	150206	150201	4	BLDT 5.08/4	164475	166073
5	BLT 5.08/5	149986	149981	5	BLT 5.08/5 B	150216	150211	5	BLDT 5.08/5	164476	166074
6	BLT 5.08/6	149996	149991	6	BLT 5.08/6 B	150226	150221	6	BLDT 5.08/6	164477	166075
7	BLT 5.08/7	150006	150001	7	BLT 5.08/7 B	150236	150231	7	BLDT 5.08/7	164478	166076
8	BLT 5.08/8	150016	150011	8	BLT 5.08/8 B	150246	150241	8	BLDT 5.08/8	164479	166077
9	BLT 5.08/9	150026	150021	9	BLT 5.08/9 B	150256	150251	9	BLDT 5.08/9	164480	166078
10	BLT 5.08/10	150036	150031	10	BLT 5.08/10 B	150266	150261	10	BLDT 5.08/10	164481	166079
11	BLT 5.08/11	150046	150041	11	BLT 5.08/11 B	150276	150271	11	BLDT 5.08/11	164482	166080
12	BLT 5.08/12	150056	150051	12	BLT 5.08/12 B	150286	150281	12	BLDT 5.08/12	164483	166081
13	BLT 5.08/13	150066	150061	13	BLT 5.08/13 B	150296	150291				
14	BLT 5.08/14	150076	150071	14	BLT 5.08/14 B	150306	150301				
15	BLT 5.08/15	150086	150081	15	BLT 5.08/15 B	150316	150311				
16	BLT 5.08/16	150096	150091	16	BLT 5.08/16 B	150326	150321				
17	BLT 5.08/17	150106	150101	17	BLT 5.08/17 B	150336	150331				
18	BLT 5.08/18	150116	150111	18	BLT 5.08/18 B	150346	150341				
19	BLT 5.08/19	150126	150121	19	BLT 5.08/19 B	150356	150351				
20	BLT 5.08/20	150136	150131	20	BLT 5.08/20 B	150366	150361				
21	BLT 5.08/21	150146	150141	21	BLT 5.08/21 B	150376	150371				
22	BLT 5.08/22	150156	150151	22	BLT 5.08/22 B	150386	150381				
23	BLT 5.08/23	150166	150161	23	BLT 5.08/23 B	150396	150391				
24	BLT 5.08/24	150176	150171	24	BLT 5.08/24 B	150406	150401				

Note: Plugs are supplied with orange or black moldings. Alternate colors are available upon request.
 *See pages 6/76-80 for locking blocks and other accessories.

Printed Circuit Board Connectors

BLZ/SL Series
5.08 mm Pitch Plugs

BLDT 5.08 B
Dual Plug
90° Orientation
Locking*
Screw Clamp

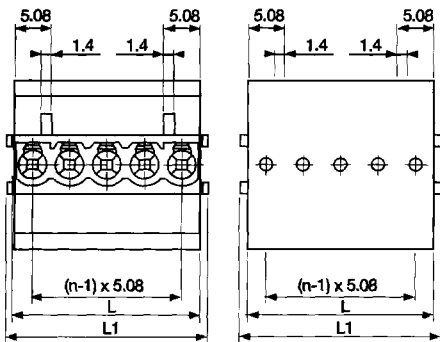
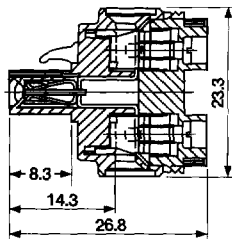

$L = n \times 5.08$
 $L1 = n \times 5.08 + 2$

BLDT 5.08 DRH
Dual Plug
90° Orientation
Screw Clamp

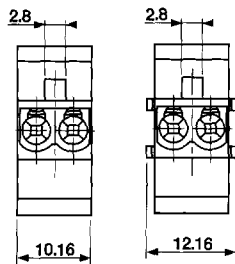
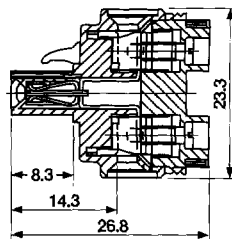

BLC 5.08
Crimp Plug
180° Orientation
Non-Locking

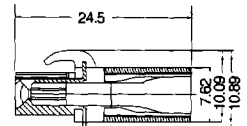

See Crimp contacts p.6/80

2	BLDT 5.08/2 B	165174	167378	2	BLDT 5.08/2 DRH	165233	170602	2	BLC 5.08/2	161049	171196
3	BLDT 5.08/3 B	165175	167379	2	BLDT 5.08/2B DRH	165234	170603	3	BLC 5.08/3	161050	171197
4	BLDT 5.08/4 B	165176	167380					4	BLC 5.08/4	161051	171198
5	BLDT 5.08/5 B	165177	167381					5	BLC 5.08/5	161052	171199
6	BLDT 5.08/6 B	165178	167382					6	BLC 5.08/6	161053	171200
7	BLDT 5.08/7 B	165179	167383					7	BLC 5.08/7	161054	171201
8	BLDT 5.08/8 B	165180	167384					8	BLC 5.08/8	161055	171202
9	BLDT 5.08/9 B	165181	167385					9	BLC 5.08/9	161056	171203
10	BLDT 5.08/10 B	165182	167386					10	BLC 5.08/10	161057	171204
11	BLDT 5.08/11 B	165183	167387					11	BLC 5.08/11	161058	171205
12	BLDT 5.08/12 B	165184	167388					12	BLC 5.08/12	161059	171206
								13	BLC 5.08/13	161060	171207
								14	BLC 5.08/14	161061	171208
								15	BLC 5.08/15	161062	171209
								16	BLC 5.08/16	161063	171210

Note: Plugs are supplied with orange or black moldings. Alternate colors are available upon request.
*See pages 6/76-80 for locking blocks and other accessories.

Printed Circuit Board Connectors

BLZ/SL Series

5.08 mm Pitch Plugs/Headers

BLC 5.08 B
Crimp Plug
180° Orientation
Locking*

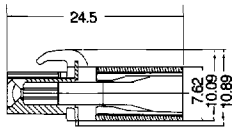

BLZF 5.08
180° Orientation
Non Locking
Tension Clamp

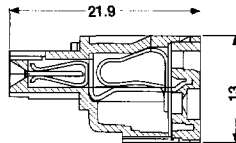

SLS 5.08
Coupler Plug
180° Orientation
Open End
Non-Locking
Screw Clamp

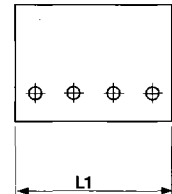
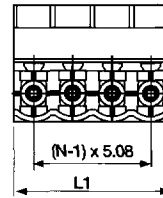
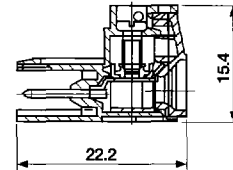

L1 = n x 5.08

See Crimp contacts p.6/80

Order No.	Designation	Part No.	orange	black	Poles	Type	Part No.	orange	black	Poles	Type	Part No.	orange	black
2	BLC 5.08/2 B	164937	171211	2	BLZF 5.08/2	167991	168916	2	SLS 5.08/2	162709	164492			
3	BLC 5.08/3 B	164938	171212	3	BLZF 5.08/3	167992	168917	3	SLS 5.08/3	162710	164493			
4	BLC 5.08/4 B	164939	171213	4	BLZF 5.08/4	167993	168918	4	SLS 5.08/4	162711	164494			
5	BLC 5.08/5 B	164940	171214	5	BLZF 5.08/5	167994	168919	5	SLS 5.08/5	162712	164495			
6	BLC 5.08/6 B	164941	171215	6	BLZF 5.08/6	167995	168920	6	SLS 5.08/6	162713	164496			
7	BLC 5.08/7 B	164942	171216	7	BLZF 5.08/7	167996	168921	7	SLS 5.08/7	162714	164497			
8	BLC 5.08/8 B	164943	171217	8	BLZF 5.08/8	167997	168922	8	SLS 5.08/8	162715	164498			
9	BLC 5.08/9 B	164944	171218	9	BLZF 5.08/9	167998	168923	9	SLS 5.08/9	162716	164499			
10	BLC 5.08/10 B	164945	171219	10	BLZF 5.08/10	167999	168924	10	SLS 5.08/10	162717	164500			
11	BLC 5.08/11 B	164946	171220	11	BLZF 5.08/11	168000	168925	11	SLS 5.08/11	162718	164501			
12	BLC 5.08/12 B	164947	171221	12	BLZF 5.08/12	168001	168926	12	SLS 5.08/12	162719	164502			
13	BLC 5.08/13 B	164948	171222	13	BLZF 5.08/13	168002	168927	13	SLS 5.08/13	162720	164503			
14	BLC 5.08/14 B	164949	171223	14	BLZF 5.08/14	168003	168928	14	SLS 5.08/14	162721	164504			
15	BLC 5.08/15 B	164950	171224	15	BLZF 5.08/15	168004	168929	15	SLS 5.08/15	162722	164505			
16	BLC 5.08/16 B	164951	171225	16	BLZF 5.08/16	168005	168930	16	SLS 5.08/16	162723	164506			
				17	BLZF 5.08/17	168006	168931	17	SLS 5.08/17	164484	164507			
				18	BLZF 5.08/18	168007	168932	18	SLS 5.08/18	164485	164508			
				19	BLZF 5.08/19	168008	168933	19	SLS 5.08/19	164486	164509			
				20	BLZF 5.08/20	168009	168934	20	SLS 5.08/20	164487	164510			
				21	BLZF 5.08/21	168010	168935	21	SLS 5.08/21	164488	164511			
				22	BLZF 5.08/22	168011	168936	22	SLS 5.08/22	164489	164512			
				23	BLZF 5.08/23	168012	168937	23	SLS 5.08/23	164490	164513			
				24	BLZF 5.08/24	168013	168938	24	SLS 5.08/24	164491	164514			

Note: Plugs are supplied with orange or black moldings. Alternate colors are available upon request.
*See pages 6/76-80 for locking blocks and other accessories.

Printed Circuit Board Connectors

BLZ/SL Series
5.08 mm Pitch Coupler Plugs

SLS 5.08 B
Coupler Plug
180° Orientation
Closed End
Locking*
Screw Clamp

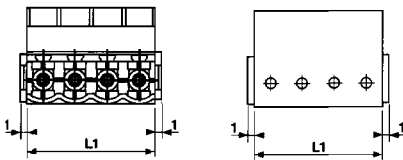
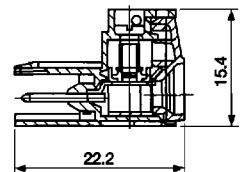

L1 = n x 5.08

SLS 5.08 T
Coupler Plug
180° Orientation
Open End
Non-Locking
Rail Mount Version
Screw Clamp

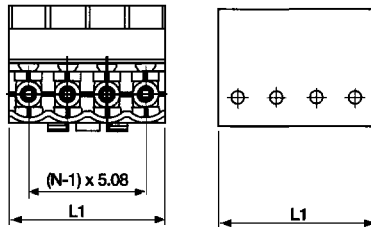
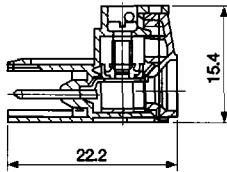

L1 = n x 5.08

SLS 5.08 TB
Coupler Plug
180° Orientation
Closed End
Locking*
Rail Mount Version
Screw Clamp

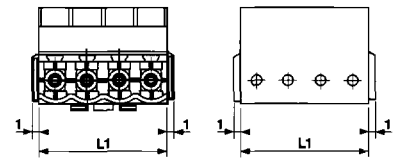
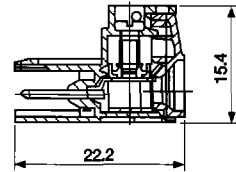

L1 = n x 5.08

2	SLS 5.08/2 B	162724	164523	4	SLS 5.08/4 T	162739	164546	4	SLS 5.08/4 TB	162760	164567
3	SLS 5.08/3 B	162725	164524	5	SLS 5.08/5 T	162740	164547	5	SLS 5.08/5 TB	162761	164568
4	SLS 5.08/4 B	162726	164525	6	SLS 5.08/6 T	162741	164548	6	SLS 5.08/6 TB	162762	164569
5	SLS 5.08/5 B	162727	164526	7	SLS 5.08/7 T	162742	164549	7	SLS 5.08/7 TB	162763	164570
6	SLS 5.08/6 B	162728	164527	8	SLS 5.08/8 T	162743	164550	8	SLS 5.08/8 TB	162764	164571
7	SLS 5.08/7 B	162729	164528	9	SLS 5.08/9 T	162744	164551	9	SLS 5.08/9 TB	162765	164572
8	SLS 5.08/8 B	162730	164529	10	SLS 5.08/10 T	162745	164552	10	SLS 5.08/10 TB	162766	164573
9	SLS 5.08/9 B	162731	164530	11	SLS 5.08/11 T	162746	164553	11	SLS 5.08/11 TB	162767	164574
10	SLS 5.08/10 B	162732	164531	12	SLS 5.08/12 T	162747	164554	12	SLS 5.08/12 TB	162768	164575
11	SLS 5.08/11 B	162733	164532	13	SLS 5.08/13 T	162748	164555	13	SLS 5.08/13 TB	162769	164576
12	SLS 5.08/12 B	162734	164533	14	SLS 5.08/14 T	162749	164556	14	SLS 5.08/14 TB	162770	164577
13	SLS 5.08/13 B	162735	164534	15	SLS 5.08/15 T	162750	164557	15	SLS 5.08/15 TB	162771	164578
14	SLS 5.08/14 B	162736	164535	16	SLS 5.08/16 T	162751	164558	16	SLS 5.08/16 TB	162772	164579
15	SLS 5.08/15 B	162737	164536	17	SLS 5.08/17 T	162752	164559	17	SLS 5.08/17 TB	162773	164580
16	SLS 5.08/16 B	162738	164537	18	SLS 5.08/18 T	162753	164560	18	SLS 5.08/18 TB	162774	164581
17	SLS 5.08/17 B	164515	164538	19	SLS 5.08/19 T	162754	164561	19	SLS 5.08/19 TB	162775	164582
18	SLS 5.08/18 B	164516	164539	20	SLS 5.08/20 T	162755	164562	20	SLS 5.08/20 TB	162776	164583
19	SLS 5.08/19 B	164517	164540	21	SLS 5.08/21 T	162756	164563	21	SLS 5.08/21 TB	162777	164584
20	SLS 5.08/20 B	164518	164541	22	SLS 5.08/22 T	162757	164564	22	SLS 5.08/22 TB	162778	164585
21	SLS 5.08/21 B	164519	164542	23	SLS 5.08/23 T	162758	164565	23	SLS 5.08/23 TB	162779	164586
22	SLS 5.08/22 B	164520	164543	24	SLS 5.08/24 T	162759	164566	24	SLS 5.08/24 TB	162780	164587
23	SLS 5.08/23 B	164521	164544								
24	SLS 5.08/24 B	164522	164545								

Note: Plugs are supplied with orange or black moldings. Alternate colors are available upon request.
*See pages 6/76-80 for locking blocks and other accessories.

SLT 5.08
Coupler Plug
TOP Entry Orientation
Open End
Non-locking
Screw Clamp

SLT 5.08 B
Coupler Plug
TOP Entry Orientation
Closed End
Locking*
Screw Clamp

SLZF 5.08
Coupler Plug
180° Orientation
Closed End
Non-Locking
Tension Clamp

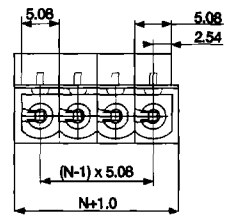
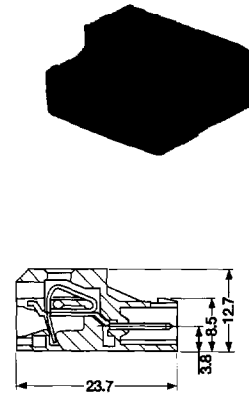
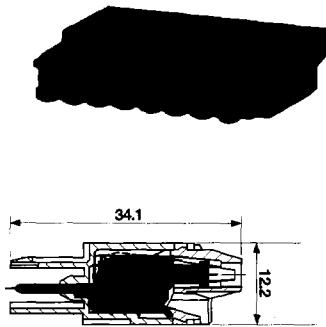
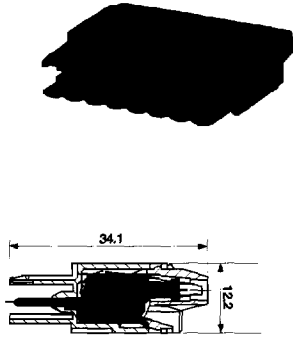

2	SLT 5.08/2	161156	164043	2	SLT 5.08/2 B	161171	164059	2	SLZF 5.08/2	167945	170544
3	SLT 5.08/3	161157	164045	3	SLT 5.08/3 B	161172	164060	3	SLZF 5.08/3	167946	170545
4	SLT 5.08/4	161158	164046	4	SLT 5.08/4 B	161173	164061	4	SLZF 5.08/4	167947	170546
5	SLT 5.08/5	161159	164047	5	SLT 5.08/5 B	161174	164062	5	SLZF 5.08/5	167948	170547
6	SLT 5.08/6	161160	164048	6	SLT 5.08/6 B	161175	164063	6	SLZF 5.08/6	167949	170548
7	SLT 5.08/7	161161	164049	7	SLT 5.08/7 B	161176	164064	7	SLZF 5.08/7	167950	170549
8	SLT 5.08/8	161162	164050	8	SLT 5.08/8 B	161177	164065	8	SLZF 5.08/8	167951	170550
9	SLT 5.08/9	161163	164051	9	SLT 5.08/9 B	161178	164066	9	SLZF 5.08/9	167952	170551
10	SLT 5.08/10	161164	164052	10	SLT 5.08/10 B	161179	164067	10	SLZF 5.08/10	167953	170552
11	SLT 5.08/11	161165	164053	11	SLT 5.08/11 B	161180	164068	11	SLZF 5.08/11	167954	170553
12	SLT 5.08/12	161166	164054	12	SLT 5.08/12 B	161181	164069	12	SLZF 5.08/12	167955	170554
13	SLT 5.08/13	161167	164055	13	SLT 5.08/13 B	161182	164070	13	SLZF 5.08/13	167956	170555
14	SLT 5.08/14	161168	164056	14	SLT 5.08/14 B	161183	164071	14	SLZF 5.08/14	167957	170556
15	SLT 5.08/15	161169	164057	15	SLT 5.08/15 B	161184	164072	15	SLZF 5.08/15	167958	170557
16	SLT 5.08/16	161170	164058	16	SLT 5.08/16 B	161185	164073	16	SLZF 5.08/16	167959	170558
								17	SLZF 5.08/17	167960	170559
								18	SLZF 5.08/18	167961	170560
								19	SLZF 5.08/19	167962	170561
								20	SLZF 5.08/20	167963	170562
								21	SLZF 5.08/21	167964	170563
								22	SLZF 5.08/22	167965	170564
								23	SLZF 5.08/23	167966	170565
								24	SLZF 5.08/24	167967	170566

Notes: Plugs and headers are supplied with black moldings. Alternate colors are available upon request. Standard solder pin length is 4.5 mm. Other lengths are available upon request. *See pages 6/76-80 for locking blocks and other accessories.

Printed Circuit Board Connectors

BLZ/SL Series
5.08 mm Pitch Headers

SL 5.08/90
Single-Level
90° Orientation
Open End
Non-Locking

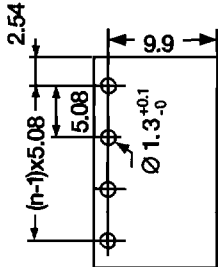
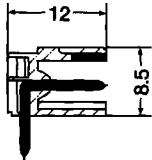

SL 5.08/90 B
Single-Level
90° Orientation
Closed End
Locking*

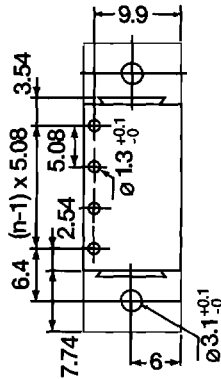
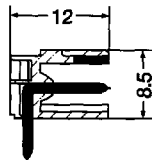

SL 5.08/135
Single-Level
135° Orientation
Open End
Non-Locking

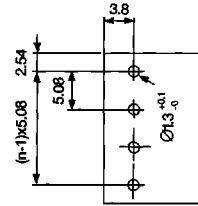
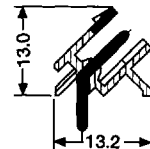

2	SL 5.08/90/2	151266	151261	2	SL 5.08/90/2 B	151496	151491	2	SL 5.08/135/2	160576	163527
3	SL 5.08/90/3	151276	151271	3	SL 5.08/90/3 B	151506	151501	3	SL 5.08/135/3	160577	163528
4	SL 5.08/90/4	151286	151281	4	SL 5.08/90/4 B	151516	151511	4	SL 5.08/135/4	160578	163529
5	SL 5.08/90/5	151296	151291	5	SL 5.08/90/5 B	151526	151521	5	SL 5.08/135/5	160579	163530
6	SL 5.08/90/6	151306	151301	6	SL 5.08/90/6 B	151536	151531	6	SL 5.08/135/6	160580	163531
7	SL 5.08/90/7	151316	151311	7	SL 5.08/90/7 B	151546	151541	7	SL 5.08/135/7	160581	163532
8	SL 5.08/90/8	151326	151321	8	SL 5.08/90/8 B	151556	151551	8	SL 5.08/135/8	160582	163533
9	SL 5.08/90/9	151336	151331	9	SL 5.08/90/9 B	151566	151561	9	SL 5.08/135/9	160583	163534
10	SL 5.08/90/10	151346	151341	10	SL 5.08/90/10 B	151576	151571	10	SL 5.08/135/10	160584	163535
11	SL 5.08/90/11	151356	151351	11	SL 5.08/90/11 B	151586	151581	11	SL 5.08/135/11	160585	163536
12	SL 5.08/90/12	151366	151361	12	SL 5.08/90/12 B	151596	151591	12	SL 5.08/135/12	160586	163537
13	SL 5.08/90/13	151376	151371	13	SL 5.08/90/13 B	151606	151601	13	SL 5.08/135/13	160587	163538
14	SL 5.08/90/14	151386	151381	14	SL 5.08/90/14 B	151616	151611	14	SL 5.08/135/14	160588	163539
15	SL 5.08/90/15	151396	151391	15	SL 5.08/90/15 B	151626	151621	15	SL 5.08/135/15	160589	163540
16	SL 5.08/90/16	151406	151401	16	SL 5.08/90/16 B	151636	151631	16	SL 5.08/135/16	160590	163541
17	SL 5.08/90/17	151416	151411	17	SL 5.08/90/17 B	151646	151641	17	SL 5.08/135/17	160591	163542
18	SL 5.08/90/18	151426	151421	18	SL 5.08/90/18 B	151656	151651	18	SL 5.08/135/18	160592	163543
19	SL 5.08/90/19	151436	151431	19	SL 5.08/90/19 B	151666	151661	19	SL 5.08/135/19	160593	163544
20	SL 5.08/90/20	151446	151441	20	SL 5.08/90/20 B	151676	151671	20	SL 5.08/135/20	160594	163545
21	SL 5.08/90/21	151456	151451	21	SL 5.08/90/21 B	151686	151681	21	SL 5.08/135/21	160595	163546
22	SL 5.08/90/22	151466	151461	22	SL 5.08/90/22 B	151696	151691	22	SL 5.08/135/22	160596	163547
23	SL 5.08/90/23	151476	151471	23	SL 5.08/90/23 B	151706	151701	23	SL 5.08/135/23	160597	163548
24	SL 5.08/90/24	151486	151481	24	SL 5.08/90/24 B	151716	151711	24	SL 5.08/135/24	160598	163549

Notes: Plugs and headers are supplied with black moldings. Alternate colors are available upon request. Standard solder pin length is 4.5 mm. Other lengths are available upon request.
*See pages 6/76-80 for locking blocks and other accessories.

SL 5.08/135 B
Single-Level
135° Orientation
Closed End
Locking*

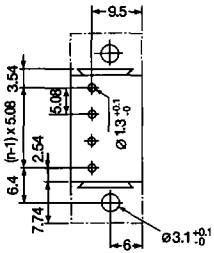
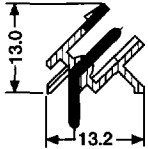
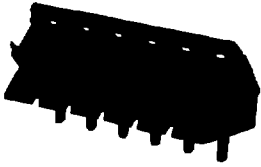

SL 5.08/180
Single-Level
180° Orientation
Open End
Non-Locking

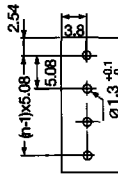
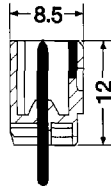

SL 5.08/180 B
Single-Level
180° Orientation
Closed End
Locking*

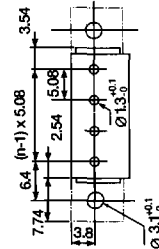
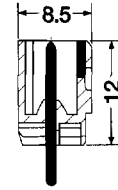

Part No.	Type	Part No. orange	Part No. black	Part No.	Type	Part No. orange	Part No. black				
2	SL 5.08/135/2 B	160599	163550	2	SL 5.08/180/2	152186	152181	2	SL 5.08/180/2 B	152416	152411
3	SL 5.08/135/3 B	160600	163551	3	SL 5.08/180/3	152196	152191	3	SL 5.08/180/3 B	152426	152421
4	SL 5.08/135/4 B	160601	163552	4	SL 5.08/180/4	152206	152201	4	SL 5.08/180/4 B	152436	152431
5	SL 5.08/135/5 B	160602	163553	5	SL 5.08/180/5	152216	152211	5	SL 5.08/180/5 B	152446	152441
6	SL 5.08/135/6 B	160603	163554	6	SL 5.08/180/6	152226	152221	6	SL 5.08/180/6 B	152456	152451
7	SL 5.08/135/7 B	160604	163555	7	SL 5.08/180/7	152236	152231	7	SL 5.08/180/7 B	152466	152461
8	SL 5.08/135/8 B	160605	163556	8	SL 5.08/180/8	152246	152241	8	SL 5.08/180/8 B	152476	152471
9	SL 5.08/135/9 B	160606	163557	9	SL 5.08/180/9	152256	152251	9	SL 5.08/180/9 B	152486	152481
10	SL 5.08/135/10 B	160607	163558	10	SL 5.08/180/10	152266	152261	10	SL 5.08/180/10 B	152496	152491
11	SL 5.08/135/11 B	160608	163559	11	SL 5.08/180/11	152276	152271	11	SL 5.08/180/11 B	152506	152501
12	SL 5.08/135/12 B	160609	163560	12	SL 5.08/180/12	152286	152281	12	SL 5.08/180/12 B	152516	152511
13	SL 5.08/135/13 B	160610	163561	13	SL 5.08/180/13	152296	152291	13	SL 5.08/180/13 B	152526	152521
14	SL 5.08/135/14 B	160611	163562	14	SL 5.08/180/14	152306	152301	14	SL 5.08/180/14 B	152536	152531
15	SL 5.08/135/15 B	160612	163563	15	SL 5.08/180/15	152316	152311	15	SL 5.08/180/15 B	152546	152541
16	SL 5.08/135/16 B	160613	163564	16	SL 5.08/180/16	152326	152321	16	SL 5.08/180/16 B	152556	152551
17	SL 5.08/135/17 B	160614	163565	17	SL 5.08/180/17	152336	152331	17	SL 5.08/180/17 B	152566	152561
18	SL 5.08/135/18 B	160615	163566	18	SL 5.08/180/18	152346	152341	18	SL 5.08/180/18 B	152576	152571
19	SL 5.08/135/19 B	160616	163567	19	SL 5.08/180/19	152356	152351	19	SL 5.08/180/19 B	152586	152581
20	SL 5.08/135/20 B	160617	163568	20	SL 5.08/180/20	152366	152361	20	SL 5.08/180/20 B	152596	152591
21	SL 5.08/135/21 B	160618	163569	21	SL 5.08/180/21	152376	152371	21	SL 5.08/180/21 B	152606	152601
22	SL 5.08/135/22 B	160619	163570	22	SL 5.08/180/22	152386	152381	22	SL 5.08/180/22 B	152616	152611
23	SL 5.08/135/23 B	160620	163571	23	SL 5.08/180/23	152396	152391	23	SL 5.08/180/23 B	152626	152621
24	SL 5.08/135/24 B	160621	163572	24	SL 5.08/180/24	152406	152401	24	SL 5.08/180/24 B	152636	152631

Notes: Plugs and headers are supplied with black moldings. Alternate colors are available upon request. Standard solder pin length is 4.5 mm. Other lengths are available upon request.
 *See pages 6/76-80 for locking blocks and other accessories.

Printed Circuit Board Connectors

BLZ/SL Series

5.08 mm Pitch Headers

SLD 5.08R/90
Double-Level In Line
90° Orientation
Closed End
Non-Locking

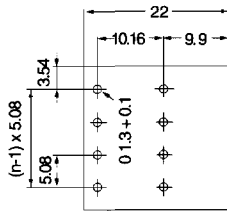
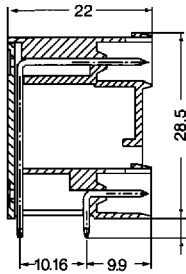

SLD 5.08R/180
Double-Level In Line
180° Orientation
Closed End
Non-Locking

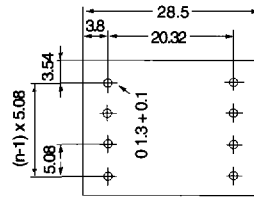
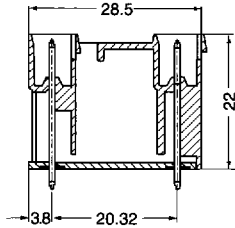
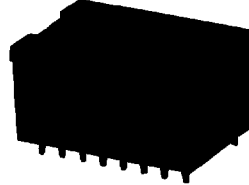

4	SLD 5.08R/90/4	1602020010	1711450010	4	SLD 5.08R/180/4	1602620010	1711680010
6	SLD 5.08R/90/6	1602030010	1675320010	6	SLD 5.08R/180/6	1602630010	1711690010
8	SLD 5.08R/90/8	1602040010	1675330010	8	SLD 5.08R/180/8	1602640010	1711700010
10	SLD 5.08R/90/10	1602050010	1711480010	10	SLD 5.08R/180/10	1602650010	1711710010
12	SLD 5.08R/90/12	1602060010	1711490010	12	SLD 5.08R/180/12	1602660010	1711720010
14	SLD 5.08R/90/14	1602070010	1711500010	14	SLD 5.08R/180/14	1602670010	1711730010
16	SLD 5.08R/90/16	1602080010	1711510010	16	SLD 5.08R/180/16	1602680010	1676730010
18	SLD 5.08R/90/18	1602090010	1711520010	18	SLD 5.08R/180/18	1602690010	1711750010
20	SLD 5.08R/90/20	1602100010	1711530010	20	SLD 5.08R/180/20	1602700010	1711760010
22	SLD 5.08R/90/22	1602110010	1711540010	22	SLD 5.08R/180/22	1602710010	1711770010
24	SLD 5.08R/90/24	1602120010	1711550010	24	SLD 5.08R/180/24	1602720010	1711780010
26	SLD 5.08R/90/26	1602130010	1711560010	26	SLD 5.08R/180/26	1602730010	1711790010
28	SLD 5.08R/90/28	1602140010	1711570010	28	SLD 5.08R/180/28	1602740010	1711800010
30	SLD 5.08R/90/30	1602150010	1711580010	30	SLD 5.08R/180/30	1602750010	1711810010
32	SLD 5.08R/90/32	1602160010	1711590010	32	SLD 5.08R/180/32	1602760010	1711820010
34	SLD 5.08R/90/34	1602170010	1711600010	34	SLD 5.08R/180/34	1602770010	1711830010
36	SLD 5.08R/90/36	1602180010	1711610010	36	SLD 5.08R/180/36	1602780010	1711840010
38	SLD 5.08R/90/38	1602190010	1711620010	38	SLD 5.08R/180/38	1602790010	1711850010
40	SLD 5.08R/90/40	1602200010	1711630010	40	SLD 5.08R/180/40	1602800010	1711860010
42	SLD 5.08R/90/42	1602210010	1711640010	42	SLD 5.08R/180/42	1602810010	1711870010
44	SLD 5.08R/90/44	1602220010	1711650010	44	SLD 5.08R/180/44	1602820010	1711880010
46	SLD 5.08R/90/46	1602230010	1711660010	46	SLD 5.08R/180/46	1602830010	1711890010
48	SLD 5.08R/90/48	1602240010	1711670010	48	SLD 5.08R/180/48	1602840010	1711900010

Notes: Plugs and headers are supplied with black moldings. Alternate colors are available upon request. Standard solder pin length is 4.5 mm. Other lengths are available upon request. See pages 6/76-80 for accessories.

Printed Circuit Board Connectors

BLZ/SL Series

5.08 mm Pitch Coupler Headers

BLL 5.08/90
Coupler Header
90° Orientation
Non-locking

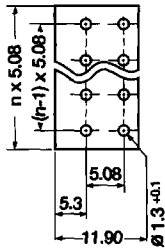
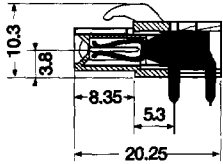

BLL 5.08/90 B
Coupler Header
90° Orientation
Locking*

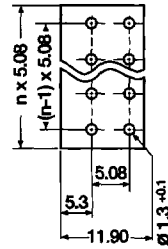
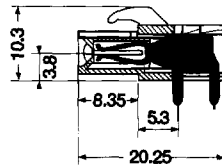

BLL 5.08/180
Coupler Header
180° Orientation
Non-Locking

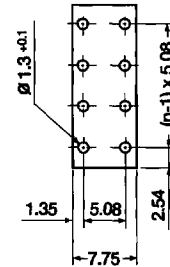
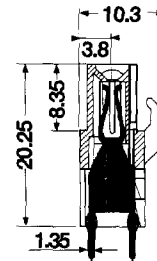
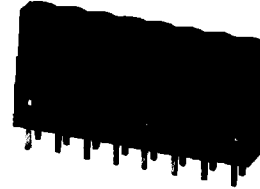

2	BLL 5.08/90/2	164592	164603	2	BLL 5.08/90/2 B	169297	168400	2	BLL 5.08/180/2	164614	164625
3	BLL 5.08/90/3	164593	164604	3	BLL 5.08/90/3 B	169298	168401	3	BLL 5.08/180/3	164615	164626
4	BLL 5.08/90/4	164594	164605	4	BLL 5.08/90/4 B	169299	168402	4	BLL 5.08/180/4	164616	164627
5	BLL 5.08/90/5	164595	164606	5	BLL 5.08/90/5 B	169300	168403	5	BLL 5.08/180/5	164617	164628
6	BLL 5.08/90/6	164596	164607	6	BLL 5.08/90/6 B	169301	168404	6	BLL 5.08/180/6	164618	164629
7	BLL 5.08/90/7	164597	164608	7	BLL 5.08/90/7 B	169302	168405	7	BLL 5.08/180/7	164619	164630
8	BLL 5.08/90/8	164598	164609	8	BLL 5.08/90/8 B	169303	168406	8	BLL 5.08/180/8	164620	164631
9	BLL 5.08/90/9	164599	164610	9	BLL 5.08/90/9 B	169304	168407	9	BLL 5.08/180/9	164621	164632
10	BLL 5.08/90/10	164600	164611	10	BLL 5.08/90/10 B	169305	168408	10	BLL 5.08/180/10	164622	164633
11	BLL 5.08/90/11	164601	164612	11	BLL 5.08/90/11 B	169306	168409	11	BLL 5.08/180/11	164623	164634
12	BLL 5.08/90/12	164602	164613	12	BLL 5.08/90/12 B	169307	168410	12	BLL 5.08/180/12	164624	164635
13	BLL 5.08/90/13	164603	164614	13	BLL 5.08/90/13 B	169308	168411	13	BLL 5.08/180/13	164625	164636
14	BLL 5.08/90/14	164604	164615	14	BLL 5.08/90/14 B	169309	168412	14	BLL 5.08/180/14	164626	164637
15	BLL 5.08/90/15	164605	164616	15	BLL 5.08/90/15 B	169310	168413	15	BLL 5.08/180/15	164627	164638
16	BLL 5.08/90/16	164606	164617	16	BLL 5.08/90/16 B	169311	168414	16	BLL 5.08/180/16	164628	164639
17	BLL 5.08/90/17	164607	164618	17	BLL 5.08/90/17 B	169312	168415	17	BLL 5.08/180/17	164629	164640
18	BLL 5.08/90/18	164608	164619	18	BLL 5.08/90/18 B	169313	168416	18	BLL 5.08/180/18	164630	164641
19	BLL 5.08/90/19	164609	164620	19	BLL 5.08/90/19 B	169314	168417	19	BLL 5.08/180/19	164631	164642
20	BLL 5.08/90/20	164610	164621	20	BLL 5.08/90/20 B	169315	168418	20	BLL 5.08/180/20	164632	164643
21	BLL 5.08/90/21	164611	164622	21	BLL 5.08/90/21 B	169316	168419	21	BLL 5.08/180/21	164633	164644
22	BLL 5.08/90/22	164612	164623	22	BLL 5.08/90/22 B	169317	168420	22	BLL 5.08/180/22	164634	164645
23	BLL 5.08/90/23	164613	164624	23	BLL 5.08/90/23 B	169318	168421	23	BLL 5.08/180/23	164635	164646
24	BLL 5.08/90/24	164614	164625	24	BLL 5.08/90/24 B	169319	168422	24	BLL 5.08/180/24	164636	164647

Notes: Plugs and headers are supplied with orange or black moldings. Alternate colors are available upon request.
Standard solder pin length is 4.5 mm. Other lengths are available upon request.

*See pages 6/76-80 for locking blocks and other accessories.

Printed Circuit Board Connectors

BLZ/SL Series
5.08 mm Pitch Headers

BLL 5.08/180 B Coupler Header 180° Orientation Locking

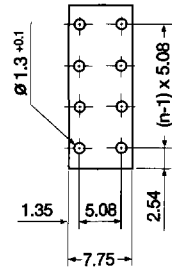
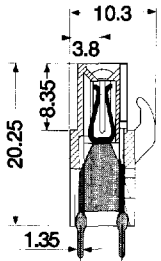
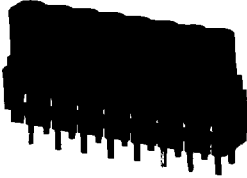

SL 5.08 KU Coupler Header 180° Orientation Closed End Locking

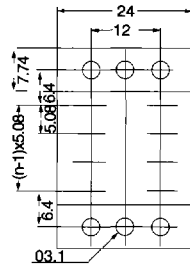
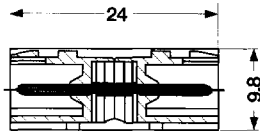

SLDF 5.08 FL Through Panel Header Single-Level

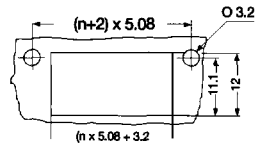
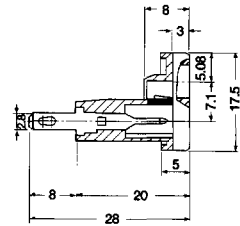

Poles	Type	Part No.	orange	black	Poles	Type	Part No.	orange	black	Poles	Type	Part No.	orange	black
2	BLL 5.08/180/2 B	169320	168423		2	SL 5.08 KU 2	159776	161303		2	SLDF 5.08/2 FL	159913	163574	
3	BLL 5.08/180/3 B	169321	168424		3	SL 5.08 KU 3	159777	161304		3	SLDF 5.08/3 FL	159914	163575	
4	BLL 5.08/180/4 B	169322	168425		4	SL 5.08 KU 4	159778	161305		4	SLDF 5.08/4 FL	159915	163576	
5	BLL 5.08/180/5 B	169323	168426		5	SL 5.08 KU 5	159779	161306		5	SLDF 5.08/5 FL	159916	163577	
6	BLL 5.08/180/6 B	169324	168427		6	SL 5.08 KU 6	159780	161307		6	SLDF 5.08/6 FL	159917	163578	
7	BLL 5.08/180/7 B	169325	168428		7	SL 5.08 KU 7	159781	161308		7	SLDF 5.08/7 FL	159918	163579	
8	BLL 5.08/180/8 B	169326	168429		8	SL 5.08 KU 8	159782	161309		8	SLDF 5.08/8 FL	159919	163580	
9	BLL 5.08/180/9 B	169327	168430		9	SL 5.08 KU 9	159783	161310		9	SLDF 5.08/9 FL	159920	163581	
10	BLL 5.08/180/10 B	169328	168431		10	SL 5.08 KU 10	159784	161311		10	SLDF 5.08/10 FL	159921	163582	
11	BLL 5.08/180/11 B	169329	168432		11	SL 5.08 KU 11	159785	161312		11	SLDF 5.08/11 FL	159922	163583	
12	BLL 5.08/180/12 B	169330	168433		12	SL 5.08 KU 12	159786	161313		12	SLDF 5.08/12 FL	159923	163584	
13	BLL 5.08/180/13 B	169331	168434		13	SL 5.08 KU 13	159787	161314		13	SLDF 5.08/13 FL	159924	163585	
14	BLL 5.08/180/14 B	169332	168435		14	SL 5.08 KU 14	159788	161315		14	SLDF 5.08/14 FL	159925	163586	
15	BLL 5.08/180/15 B	169333	168436		15	SL 5.08 KU 15	159789	161316		15	SLDF 5.08/15 FL	159926	163587	
16	BLL 5.08/180/16 B	169334	168437		16	SL 5.08 KU 16	159790	161317		16	SLDF 5.08/16 FL	159927	163588	
17	BLL 5.08/180/17 B	169335	168438		17	SL 5.08 KU 17	159791	161318						
18	BLL 5.08/180/18 B	169336	168439		18	SL 5.08 KU 18	159792	161319						
19	BLL 5.08/180/19 B	169337	168440		19	SL 5.08 KU 19	159793	161320						
20	BLL 5.08/180/20 B	169338	168441		20	SL 5.08 KU 20	159794	161321						
21	BLL 5.08/180/21 B	169339	168442		21	SL 5.08 KU 21	159795	161322						
22	BLL 5.08/180/22 B	169340	168443		22	SL 5.08 KU 22	159796	161323						
23	BLL 5.08/180/23 B	169341	168444		23	SL 5.08 KU 23	159797	161324						
24	BLL 5.08/180/24 B	169342	168445		24	SL 5.08 KU 24	159798	161325						

Notes: Plugs and headers are supplied with black moldings. Alternate colors are available upon request. Standard solder pin length is 4.5 mm. Other lengths are available upon request. See pages 6/76-80 for accessories.

Printed Circuit Board Connectors

BLZ/SL Series
7.50 mm Pitch Plugs

BLZ 7.50
180° Orientation
Non-Locking
Screw Clamp

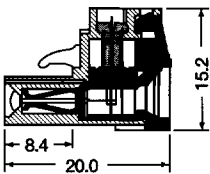

BLZ 7.50 B
180° Orientation
Locking*
Screw Clamp

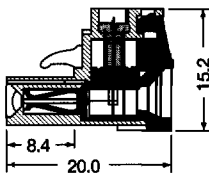

Poles	Type	Part No.	Poles	Type	Part No.
2	BLZ 7.50/2 BK	162803	2	BLZ 7.50/2 B BK	162825
3	BLZ 7.50/3 BK	162804	3	BLZ 7.50/3 B BK	162826
4	BLZ 7.50/4 BK	162805	4	BLZ 7.50/4 B BK	162827
5	BLZ 7.50/5 BK	162806	5	BLZ 7.50/5 B BK	162828
6	BLZ 7.50/6 BK	162807	6	BLZ 7.50/6 B BK	162829
7	BLZ 7.50/7 BK	162808	7	BLZ 7.50/7 B BK	162830
8	BLZ 7.50/8 BK	162809	8	BLZ 7.50/8 B BK	162831
9	BLZ 7.50/9 BK	162810	9	BLZ 7.50/9 B BK	162832
10	BLZ 7.50/10 BK	162811	10	BLZ 7.50/10 B BK	162833
11	BLZ 7.50/11 BK	162812	11	BLZ 7.50/11 B BK	162834
12	BLZ 7.50/12 BK	162813	12	BLZ 7.50/12 B BK	162835

Notes: Plugs and headers are supplied with black moldings. Alternate colors are available upon request.
 Standard solder pin length is 4.5 mm. Other lengths are available upon request.
 *See pages 6/76-80 for locking blocks and other accessories.

Printed Circuit Board Connectors

BLZ/SL Series
7.50 mm Pitch Plugs

SL 7.50/90
Single-Level
90° Orientation
Open End
Non-Locking

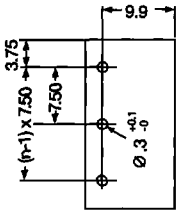
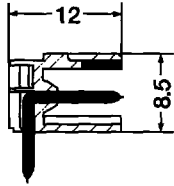

SL 7.50/90 B
Single-Level
90° Orientation
Closed End
Locking*

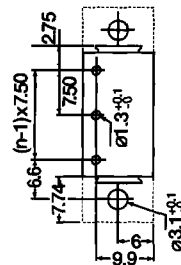
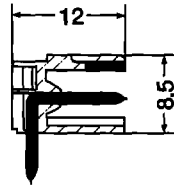

SL 7.50/180
Single-Level
180° Orientation
Open End
Non-Locking

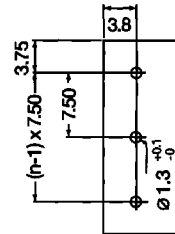
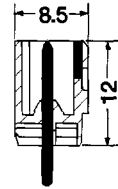

2	SL 7.50/90/2 BK	162869	2	SL 7.50/90/2 B BK	162891	2	SL 7.50/180/2 BK	162935
3	SL 7.50/90/3 BK	162870	3	SL 7.50/90/3 B BK	162892	3	SL 7.50/180/3 BK	162936
4	SL 7.50/90/4 BK	162871	4	SL 7.50/90/4 B BK	162893	4	SL 7.50/180/4 BK	162937
5	SL 7.50/90/5 BK	162872	5	SL 7.50/90/5 B BK	162894	5	SL 7.50/180/5 BK	162938
6	SL 7.50/90/6 BK	162873	6	SL 7.50/90/6 B BK	162895	6	SL 7.50/180/6 BK	162939
7	SL 7.50/90/7 BK	162874	7	SL 7.50/90/7 B BK	162896	7	SL 7.50/180/7 BK	162940
8	SL 7.50/90/8 BK	162875	8	SL 7.50/90/8 B BK	162897	8	SL 7.50/180/8 BK	162941
9	SL 7.50/90/9 BK	162876	9	SL 7.50/90/9 B BK	162898	9	SL 7.50/180/9 BK	162942
10	SL 7.50/90/10 BK	162877	10	SL 7.50/90/10 B BK	162899	10	SL 7.50/180/10 BK	162943
11	SL 7.50/90/11 BK	162878	11	SL 7.50/90/11 B BK	162900	11	SL 7.50/180/11 BK	162944
12	SL 7.50/90/12 BK	162879	12	SL 7.50/90/12 B BK	162901	12	SL 7.50/180/12 BK	162945

Notes: Plugs and headers are supplied with black moldings. Alternate colors are available upon request. Standard solder pin length is 4.5 mm. Other lengths are available upon request. *See pages 6/76-80 for locking blocks and other accessories.

SL 7.50/180 B
 Single-Level
 180° Orientation
 Closed End
 Locking*

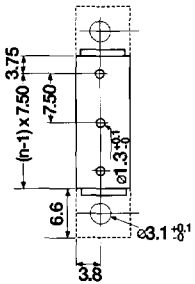
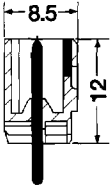

2	SL 7.50/180/2 B BK	162957	
3	SL 7.50/180/3 B BK	162958	
4	SL 7.50/180/4 B BK	162959	
5	SL 7.50/180/5 B BK	162960	
6	SL 7.50/180/6 B BK	162961	
7	SL 7.50/180/7 B BK	162962	
8	SL 7.50/180/8 B BK	162963	
9	SL 7.50/180/9 B BK	162964	
10	SL 7.50/180/10 B BK	162965	
11	SL 7.50/180/11 B BK	162966	
12	SL 7.50/180/12 B BK	162967	

Notes: Plugs and headers are supplied with black moldings. Alternate colors are available upon request.
 Standard solder pin length is 4.5 mm. Other lengths are available upon request.
 *See pages 6/76-80 for locking blocks and other accessories.

Printed Circuit Board Connectors

BLZ/SL Series
7.62 mm Pitch Plugs

BLZ 7.62
180° Orientation
Non-Locking
Screw Clamp

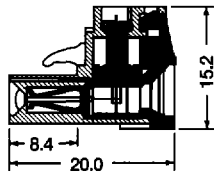

BLZ 7.62 B
180° Orientation
Locking*
Screw Clamp

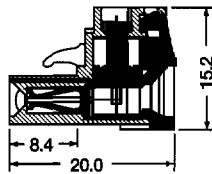

2	BLZ 7.62/2 BK	162316	2	BLZ 7.62/2 B BK	162349
3	BLZ 7.62/3 BK	162317	3	BLZ 7.62/3 B BK	162350
4	BLZ 7.62/4 BK	162318	4	BLZ 7.62/4 B BK	162351
5	BLZ 7.62/5 BK	162319	5	BLZ 7.62/5 B BK	162352
6	BLZ 7.62/6 BK	162320	6	BLZ 7.62/6 B BK	162353
7	BLZ 7.62/7 BK	162321	7	BLZ 7.62/7 B BK	162354
8	BLZ 7.62/8 BK	162322	8	BLZ 7.62/8 B BK	162355
9	BLZ 7.62/9 BK	162323	9	BLZ 7.62/9 B BK	162356
10	BLZ 7.62/10 BK	162324	10	BLZ 7.62/10 B BK	162357
11	BLZ 7.62/11 BK	162325	11	BLZ 7.62/11 B BK	162358
12	BLZ 7.62/12 BK	162326	12	BLZ 7.62/12 B BK	162359

*Notes: Plugs and headers are supplied with black moldings. Alternate colors are available upon request. Standard solder pin length is 4.5 mm. Other lengths are available upon request. *See pages 6/76-80 for locking blocks and other accessories.*

Printed Circuit Board Connectors

BLZ/SL Series

7.62 mm Pitch Plugs

SL 7.62/90
Single-Level
90° Orientation
Open End
Non-Locking

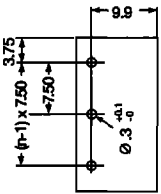
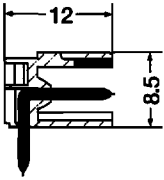

SL 7.62/90 B
Single-Level
90° Orientation
Closed End
Locking*

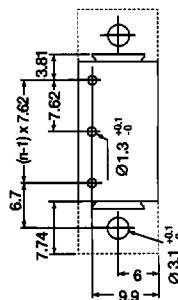
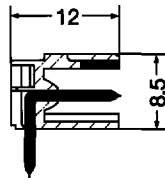

SL 7.62/180
Single-Level
180° Orientation
Open End
Non-Locking

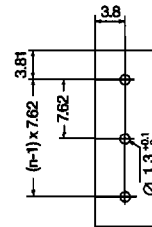
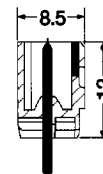

2	SL 7.62/90/2 BK	162382	2	SL 7.62/90/2 B BK	162404	2	SL 7.62/180/2 BK	162470
3	SL 7.62/90/3 BK	162383	3	SL 7.62/90/3 B BK	162405	3	SL 7.62/180/3 BK	162471
4	SL 7.62/90/4 BK	162384	4	SL 7.62/90/4 B BK	162406	4	SL 7.62/180/4 BK	162472
5	SL 7.62/90/5 BK	162385	5	SL 7.62/90/5 B BK	162407	5	SL 7.62/180/5 BK	162473
6	SL 7.62/90/6 BK	162386	6	SL 7.62/90/6 B BK	162408	6	SL 7.62/180/6 BK	162474
7	SL 7.62/90/7 BK	162387	7	SL 7.62/90/7 B BK	162409	7	SL 7.62/180/7 BK	162475
8	SL 7.62/90/8 BK	162388	8	SL 7.62/90/8 B BK	162410	8	SL 7.62/180/8 BK	162476
9	SL 7.62/90/9 BK	162389	9	SL 7.62/90/9 B BK	162411	9	SL 7.62/180/9 BK	162477
10	SL 7.62/90/10 BK	162390	10	SL 7.62/90/10 B BK	162412	10	SL 7.62/180/10 BK	162478
11	SL 7.62/90/11 BK	162391	11	SL 7.62/90/11 B BK	162413	11	SL 7.62/180/11 BK	162479
12	SL 7.62/90/12 BK	162392	12	SL 7.62/90/12 B BK	162414	12	SL 7.62/180/12 BK	162480

Notes: Plugs and headers are supplied with black moldings. Alternate colors are available upon request.
Standard solder pin length is 4.5 mm. Other lengths are available upon request.
*See pages 6/76-80 for locking blocks and other accessories.

Printed Circuit Board Connectors

BLZ/SL Series
7.62 mm Pitch Plugs

SL 7.62/180 B
Single-Level
180° Orientation
Closed End
Locking*

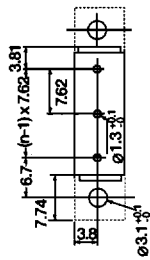
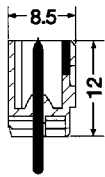

2	SL 7.62/180/2 B BK	162492	
3	SL 7.62/180/3 B BK	162493	
4	SL 7.62/180/4 B BK	162494	
5	SL 7.62/180/5 B BK	162495	
6	SL 7.62/180/6 B BK	162496	
7	SL 7.62/180/7 B BK	162497	
8	SL 7.62/180/8 B BK	162498	
9	SL 7.62/180/9 B BK	162499	
10	SL 7.62/180/10 B BK	162500	
11	SL 7.62/180/11 B BK	162501	
12	SL 7.62/180/12 B BK	162502	

Notes: Plugs and headers are supplied with black moldings. Alternate colors are available upon request. Standard solder pin length is 4.5 mm. Other lengths are available upon request. *See pages 6/76-80 for locking blocks and other accessories.



Printed Circuit Board Connectors

BLA/SLA Series

5.08 mm Pitch

BLA Plugs

Screw Clamp Plugs

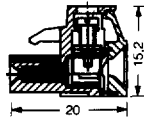

BLA 2...24

Pitch 5.08 mm

Poles	Type	Cat. No.
2	BLA 2 OG	128176
3	BLA 3 OG	128186
4	BLA 4 OG	128196
5	BLA 5 OG	128206
6	BLA 6 OG	128216
7	BLA 7 OG	128226
8	BLA 8 OG	128236
9	BLA 9 OG	128246
10	BLA 10 OG	128256
11	BLA 11 OG	128266
12	BLA 12 OG	128276
13	BLA 13 OG	128286
14	BLA 14 OG	128296
15	BLA 15 OG	128306
16	BLA 16 OG	128316
17	BLA 17 OG	128326
18	BLA 18 OG	128336
19	BLA 19 OG	128346
20	BLA 20 OG	128356
21	BLA 21 OG	128366
22	BLA 22 OG	131426
23	BLA 23 OG	131436
24	BLA 24 OG	131446

BLAC Plugs

Crimp Plugs

without Latching Hooks

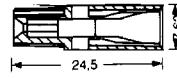

BLAC 2...24

Pitch 5.08 mm

Poles	Type	Cat. No.
2	BLAC 2 OG	157820
3	BLAC 3 OG	147816
4	BLAC 4 OG	147826
5	BLAC 5 OG	157752
6	BLAC 6 OG	147836
7	BLAC 7 OG	157753
8	BLAC 8 OG	147846
9	BLAC 9 OG	157754
10	BLAC 10 OG	147856
11	BLAC 11 OG	157755
12	BLAC 12 OG	147866
13	BLAC 13 OG	160104
14	BLAC 14 OG	159414
15	BLAC 15 OG	160105
16	BLAC 16 OG	147876
17	BLAC 17 OG	160106
18	BLAC 18 OG	160107
19	BLAC 19 OG	160108
20	BLAC 20 OG	147886
21	BLAC 21 OG	160109
22	BLAC 22 OG	160110
23	BLAC 23 OG	160111
24	BLAC 24 OG	147896

BLAC Plugs

Crimp Plugs

with Latching Hooks

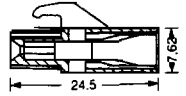

BLAC 2...24R

Pitch 5.08 mm

Poles	Type	Cat. No.
2	BLAC 2R OG	157822
3	BLAC 3R OG	147796
4	BLAC 4R OG	147806
5	BLAC 5R OG	157748
6	BLAC 6R OG	147816
7	BLAC 7R OG	157749
8	BLAC 8R OG	147826
9	BLAC 9R OG	157750
10	BLAC 10R OG	147836
11	BLAC 11R OG	157751
12	BLAC 12R OG	147846
13	BLAC 13R OG	160112
14	BLAC 14R OG	159416
15	BLAC 15R OG	160113
16	BLAC 16R OG	147856
17	BLAC 17R OG	160114
18	BLAC 18R OG	160115
19	BLAC 19R OG	160116
20	BLAC 20R OG	147866
21	BLAC 21R OG	160117
22	BLAC 22R OG	160118
23	BLAC 23R OG	160119
24	BLAC 24R OG	147876

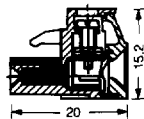

BLA 2...24B

Pitch 5.08 mm

Screw Clamp Plugs with Dovetails

Poles	Type	Cat. No.
2	BLA 2B OG	135606
3	BLA 3B OG	135616
4	BLA 4B OG	135626
5	BLA 5B OG	135636
6	BLA 6B OG	135646
7	BLA 7B OG	135656
8	BLA 8B OG	135666
9	BLA 9B OG	135676
10	BLA 10B OG	135686
11	BLA 11B OG	135696
12	BLA 12B OG	135706
13	BLA 13B OG	135716
14	BLA 14B OG	135726
15	BLA 15B OG	135736
16	BLA 16B OG	135746
17	BLA 17B OG	135756
18	BLA 18B OG	135766
19	BLA 19B OG	135776
20	BLA 20B OG	135786
21	BLA 21B OG	135796
22	BLA 22B OG	135806
23	BLA 23B OG	135816
24	BLA 24B OG	135826

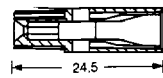

BLAC 2...24B

Pitch 5.08 mm

Crimp Plugs with Dovetails

Poles	Type	Cat. No.
2	BLAC 2B OG	157821
3	BLAC 3B OG	147706
4	BLAC 4B OG	147716
5	BLAC 5B OG	157744
6	BLAC 6B OG	147726
7	BLAC 7B OG	157745
8	BLAC 8B OG	147736
9	BLAC 9B OG	157746
10	BLAC 10B OG	147746
11	BLAC 11B OG	157747
12	BLAC 12B OG	147756
13	BLAC 13B OG	160120
14	BLAC 14B OG	159415
15	BLAC 15B OG	160121
16	BLAC 16B OG	147766
17	BLAC 17B OG	160122
18	BLAC 18B OG	160123
19	BLAC 19B OG	160124
20	BLAC 20B OG	147776
21	BLAC 21B OG	160125
22	BLAC 22B OG	160126
23	BLAC 23B OG	160127
24	BLAC 24B OG	147786

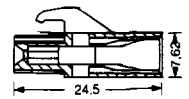

BLAC 2...24BR

Pitch 5.08 mm

Crimp Plugs with Dovetails

Poles	Type	Cat. No.
2	BLAC 2BR OG	157823
3	BLAC 3BR OG	147886
4	BLAC 4BR OG	147896
5	BLAC 5BR OG	144416
6	BLAC 6BR OG	147906
7	BLAC 7BR OG	157743
8	BLAC 8BR OG	147916
9	BLAC 9BR OG	157742
10	BLAC 10BR OG	147926
11	BLAC 11BR OG	157741
12	BLAC 12BR OG	147936
13	BLAC 13BR OG	160128
14	BLAC 14BR OG	159417
15	BLAC 15BR OG	160129
16	BLAC 16BR OG	147946
17	BLAC 17BR OG	160130
18	BLAC 18BR OG	160131
19	BLAC 19BR OG	160132
20	BLAC 20BR OG	147956
21	BLAC 21BR OG	160133
22	BLAC 22BR OG	160134
23	BLAC 23BR OG	160135
24	BLAC 24BR OG	147966

See pages 6/76-80 for crimp contacts and other accessories.

BLAT Connector Plugs

Top Entry Plugs

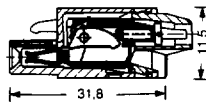

Version B



BLAT 2...24

Pitch 5.08 mm

Poles	Type	Cat. No.
2	BLAT 2 OG	148426
3	BLAT 3 OG	148436
4	BLAT 4 OG	148446
5	BLAT 5 OG	148456
6	BLAT 6 OG	148466
7	BLAT 7 OG	148476
8	BLAT 8 OG	148486
9	BLAT 9 OG	148496
10	BLAT 10 OG	148506
11	BLAT 11 OG	148516
12	BLAT 12 OG	148526
13	BLAT 13 OG	148536
14	BLAT 14 OG	148546
15	BLAT 15 OG	148556
16	BLAT 16 OG	148566
17	BLAT 17 OG	148576
18	BLAT 18 OG	148586
19	BLAT 19 OG	148596
20	BLAT 20 OG	148606
21	BLAT 21 OG	148616
22	BLAT 22 OG	148626
23	BLAT 23 OG	148636
24	BLAT 24 OG	148646

BLAT 2...24B

Pitch 5.08 mm

Top Entry Plugs with Dovetails

Poles	Type	Cat. No.
2	BLAT 2B OG	148656
3	BLAT 3B OG	148666
4	BLAT 4B OG	148676
5	BLAT 5B OG	148686
6	BLAT 6B OG	148696
7	BLAT 7B OG	148706
8	BLAT 8B OG	148716
9	BLAT 9B OG	148726
10	BLAT 10B OG	148736
11	BLAT 11B OG	148746
12	BLAT 12B OG	148756
13	BLAT 13B OG	148766
14	BLAT 14B OG	148776
15	BLAT 15B OG	148786
16	BLAT 16B OG	148796
17	BLAT 17B OG	148806
18	BLAT 18B OG	148816
19	BLAT 19B OG	148826
20	BLAT 20B OG	148836
21	BLAT 21B OG	148846
22	BLAT 22B OG	148856
23	BLAT 23B OG	148866
24	BLAT 24B OG	148876

SLAS Plugs

Coupler Plugs

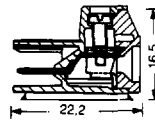

Version B

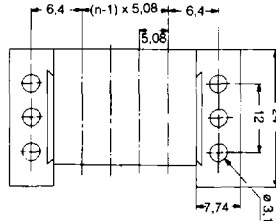

SLAS 4...24B

Pitch 5.08 mm

Poles	Type	Cat. No.
4	SLAS 4 OG	157174
6	SLAS 6 OG	157175
8	SLAS 8 OG	157176
10	SLAS 10 OG	157177
12	SLAS 12 OG	157178
16	SLAS 16 OG	157179
20	SLAS 20 OG	157180
24	SLAS 24 OG	157181

SLAS 4...24B

Pitch 5.08 mm

Coupler Plugs with Dovetails

Poles	Type	Cat. No.
4	SLAS 4B OG	157182
6	SLAS 6B OG	157183
8	SLAS 8B OG	157184
10	SLAS 10B OG	157185
12	SLAS 12B OG	157186
16	SLAS 16B OG	157188
20	SLAS 20B OG	157189
24	SLAS 24B OG	157190

SLA KU Headers

Coupler Headers

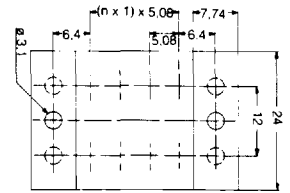
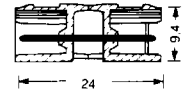

SLA KU 2...12

Pitch 5.08 mm

Poles	Type	Cat. No.
2	SLA KU 2 OG	135966
3	SLA KU 3 OG	135976
4	SLA KU 4 OG	134276
5	SLA KU 5 OG	135986
6	SLA KU 6 OG	135996
7	SLA KU 7 OG	136006
8	SLA KU 8 OG	134286
9	SLA KU 9 OG	136016
10	SLA KU 10 OG	136026
11	SLA KU 11 OG	136036
12	SLA KU 12 OG	136046

Note: Plugs and headers are supplied with orange moldings. Alternate colors are available upon request.

* See pages 6/76-80 for locking blocks and other accessories.

Printed Circuit Board Connectors

BLA/SLA Series

5.08 mm Pitch

SLA 90 Headers

90° Headers with open ends

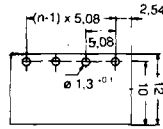

SLA 90 Headers

90° Headers with closed ends

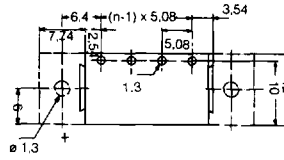
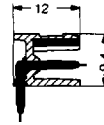

SLA 180 Headers

180° Headers with open ends

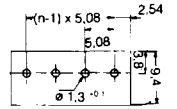
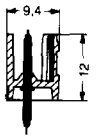
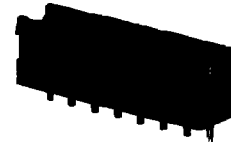

SLA 90/2...24

Pitch 5.08 mm

SLA 90/2...24B

Pitch 5.08 mm

SLA 180/2...24

Pitch 5.08 mm

Poles	Type	Cat. No.	Poles	Type	Cat. No.	Poles	Type	Cat. No.
2	SLA 90/2 OG	134686	2	SLA 90/2B OG	135146	2	SLA 180/2 OG	134916
3	SLA 90/3 OG	134696	3	SLA 90/3B OG	135156	3	SLA 180/3 OG	134926
4	SLA 90/4 OG	134706	4	SLA 90/4B OG	135166	4	SLA 180/4 OG	134936
5	SLA 90/5 OG	134716	5	SLA 90/5B OG	135176	5	SLA 180/5 OG	134946
6	SLA 90/6 OG	134726	6	SLA 90/6B OG	135186	6	SLA 180/6 OG	134956
7	SLA 90/7 OG	134736	7	SLA 90/7B OG	135196	7	SLA 180/7 OG	134966
8	SLA 90/8 OG	134746	8	SLA 90/8B OG	135206	8	SLA 180/8 OG	134976
9	SLA 90/9 OG	134756	9	SLA 90/9B OG	135216	9	SLA 180/9 OG	134986
10	SLA 90/10 OG	134766	10	SLA 90/10B OG	135226	10	SLA 180/10 OG	134996
11	SLA 90/11 OG	134776	11	SLA 90/11B OG	135236	11	SLA 180/11 OG	135006
12	SLA 90/12 OG	134786	12	SLA 90/12B OG	135246	12	SLA 180/12 OG	135016
13	SLA 90/13 OG	134796	13	SLA 90/13B OG	135256	13	SLA 180/13 OG	135026
14	SLA 90/14 OG	134806	14	SLA 90/14B OG	135266	14	SLA 180/14 OG	135036
15	SLA 90/15 OG	134816	15	SLA 90/15B OG	135276	15	SLA 180/15 OG	135046
16	SLA 90/16 OG	134826	16	SLA 90/16B OG	135286	16	SLA 180/16 OG	135056
17	SLA 90/17 OG	134836	17	SLA 90/17B OG	135296	17	SLA 180/17 OG	135066
18	SLA 90/18 OG	134846	18	SLA 90/18B OG	135306	18	SLA 180/18 OG	135076
19	SLA 90/19 OG	134856	19	SLA 90/19B OG	135316	19	SLA 180/19 OG	135086
20	SLA 90/20 OG	134866	20	SLA 90/20B OG	135326	20	SLA 180/20 OG	135096
21	SLA 90/21 OG	134876	21	SLA 90/21B OG	135336	21	SLA 180/21 OG	135106
22	SLA 90/22 OG	134886	22	SLA 90/22B OG	135346	22	SLA 180/22 OG	135116
23	SLA 90/23 OG	134896	23	SLA 90/23B OG	135356	23	SLA 180/23 OG	135126
24	SLA 90/24 OG	134906	24	SLA 90/24B OG	135366	24	SLA 180/24 OG	135136

Note: Plugs and headers are supplied with orange moldings. Alternate colors are available upon request. * See pages 6/76-80 for locking blocks and other accessories.

SLA 180 Headers

180° Headers with closed ends

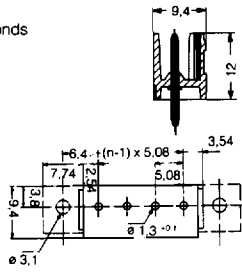

SLAD 90/4...48

90° Double-level header with open ends

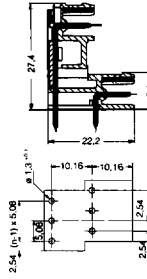

SLAD 180/4...48

180° Double-level header with open ends

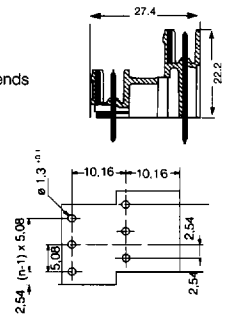

SLA 180/2...24B

Poles	Type	Cat. No.
2	SLA 180/2B OG	135376
3	SLA 180/3B OG	135386
4	SLA 180/4B OG	135396
5	SLA 180/5B OG	135406
6	SLA 180/6B OG	135416
7	SLA 180/7B OG	135426
8	SLA 180/8B OG	135436
9	SLA 180/9B OG	135446
10	SLA 180/10B OG	135456
11	SLA 180/11B OG	135466
12	SLA 180/12B OG	135476
13	SLA 180/13B OG	135486
14	SLA 180/14B OG	135496
15	SLA 180/15B OG	135506
16	SLA 180/16B OG	135516
17	SLA 180/17B OG	135526
18	SLA 180/18B OG	135536
19	SLA 180/19B OG	135546
20	SLA 180/20B OG	135556
21	SLA 180/21B OG	135566
22	SLA 180/22B OG	135576
23	SLA 180/23B OG	135586
24	SLA 180/24B OG	135596

Pitch 5.08 mm

Poles	Type	Cat. No.
4	SLAD 90/4 OG	132166
6	SLAD 90/6 OG	132176
8	SLAD 90/8 OG	138556
10	SLAD 90/10 OG	138566
12	SLAD 90/12 OG	138576
14	SLAD 90/14 OG	138586
16	SLAD 90/16 OG	138596
18	SLAD 90/18 OG	138606
20	SLAD 90/20 OG	138616
22	SLAD 90/22 OG	138626
24	SLAD 90/24 OG	138636
26	SLAD 90/26 OG	138646
28	SLAD 90/28 OG	138656
30	SLAD 90/30 OG	138666
32	SLAD 90/32 OG	138676
34	SLAD 90/34 OG	138686
36	SLAD 90/36 OG	138696
38	SLAD 90/38 OG	138706
40	SLAD 90/40 OG	138716
42	SLAD 90/42 OG	138726
44	SLAD 90/44 OG	138736
46	SLAD 90/46 OG	138746
48	SLAD 90/48 OG	138757

Pitch 5.08 mm

Poles	Type	Cat. No.
4	SLAD 180/4 OG	132246
6	SLAD 180/6 OG	132256
8	SLAD 180/8 OG	138346
10	SLAD 180/10 OG	138356
12	SLAD 180/12 OG	138366
14	SLAD 180/14 OG	138376
16	SLAD 180/16 OG	138386
18	SLAD 180/18 OG	138396
20	SLAD 180/20 OG	138406
22	SLAD 180/22 OG	138416
24	SLAD 180/24 OG	138426
26	SLAD 180/26 OG	138436
28	SLAD 180/28 OG	138446
30	SLAD 180/30 OG	138456
32	SLAD 180/32 OG	138466
34	SLAD 180/34 OG	138476
36	SLAD 180/36 OG	138486
38	SLAD 180/38 OG	138496
40	SLAD 180/40 OG	138506
42	SLAD 180/42 OG	138516
44	SLAD 180/44 OG	138526
46	SLAD 180/46 OG	138536
48	SLAD 180/48 OG	138546

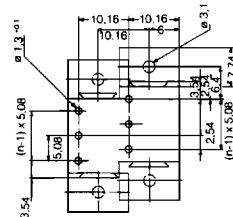

SLAD 90/4...48B

Pitch 5.08 mm

90° Double-level header with closed ends

Poles	Type	Cat. No.
4	SLAD 90/4B OG	132226
6	SLAD 90/6B OG	132236
8	SLAD 90/8B OG	138766
10	SLAD 90/10B OG	138776
12	SLAD 90/12B OG	138876
14	SLAD 90/14B OG	138796
16	SLAD 90/16B OG	138806
18	SLAD 90/16B OG	138816
20	SLAD 90/20B OG	138826
22	SLAD 90/22B OG	138836
24	SLAD 90/24B OG	138846
26	SLAD 90/26B OG	138946
28	SLAD 90/28B OG	138956
30	SLAD 90/30B OG	138966
32	SLAD 90/32B OG	138976
34	SLAD 90/34B OG	138986
36	SLAD 90/36B OG	138996
38	SLAD 90/38B OG	139006
40	SLAD 90/40B OG	139016
42	SLAD 90/42B OG	139026
44	SLAD 90/44B OG	139036
46	SLAD 90/46B OG	139046
48	SLAD 90/48B OG	143756

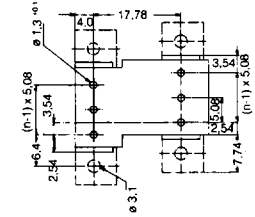

SLAD 180/4...48B

Pitch 5.08 mm

180° Double-level header with closed ends

Poles	Type	Cat. No.
4	SLAD 180/4B OG	132306
6	SLAD 180/6B OG	132316
8	SLAD 180/8B OG	139186
10	SLAD 180/10B OG	139196
12	SLAD 180/12B OG	139206
14	SLAD 180/14B OG	139216
16	SLAD 180/16B OG	139226
18	SLAD 180/18B OG	139236
20	SLAD 180/20B OG	139246
22	SLAD 180/22B OG	139256
24	SLAD 180/24B OG	139266
26	SLAD 180/26B OG	139366
28	SLAD 180/28B OG	139376
30	SLAD 180/30B OG	139386
32	SLAD 180/32B OG	139396
34	SLAD 180/34B OG	139406
36	SLAD 180/36B OG	139416
38	SLAD 180/38B OG	139426
40	SLAD 180/40B OG	139436
42	SLAD 180/42B OG	139446
44	SLAD 180/44B OG	139456
46	SLAD 180/46B OG	139466
48	SLAD 180/48B OG	139476

Note: Plugs and headers are supplied with orange moldings. Alternate colors are available upon request.

* See pages 6/76-80 for locking blocks and other accessories.

Printed Circuit Board Connectors

BL/SL Series
5.08/5.00 mm Pitch

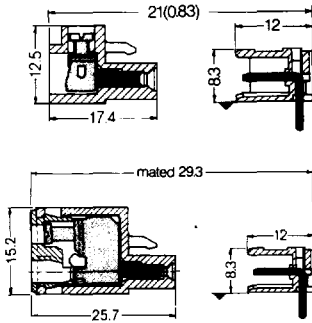

Mated dimension
BL/SL and BL TOP/SL

BL Plug

180° Plug

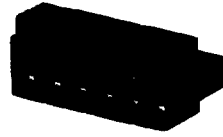

BL TOP Plug

Top Entry Plug

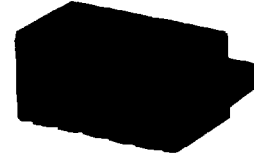
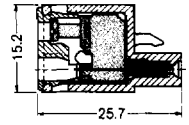

	Poles	Type	Cat. No.	Poles	Type	Cat. No.
Pitch	5.08 mm (.200 in)			5.08 mm (.200 in)		
	2	BL 5.08/2	125916	2	BL TOP 5.08/2	133586
	3	BL 5.08/3	125926	3	BL TOP 5.08/3	133596
	4	BL 5.08/4	125936	4	BL TOP 5.08/4	133606
	5	BL 5.08/5	125946	5	BL TOP 5.08/5	133616
	6	BL 5.08/6	125956	6	BL TOP 5.08/6	133626
	7	BL 5.08/7	125966	7	BL TOP 5.08/7	133636
	8	BL 5.08/8	125976	8	BL TOP 5.08/8	133646
	9	BL 5.08/9	125986	9	BL TOP 5.08/9	133656
	10	BL 5.08/10	125996	10	BL TOP 5.08/10	133666
	11	BL 5.08/11	126006	11	BL TOP 5.08/11	133676
	12	BL 5.08/12	126016	12	BL TOP 5.08/12	133686
	13	BL 5.08/13	126026			
	14	BL 5.08/14	126036			
	15	BL 5.08/15	126046			
	16	BL 5.08/16	127546			
Pitch	5.00 mm (.197 in)					
	2	BL 5.00/2	22696			
	3	BL 5.00/3	22706			
	4	BL 5.00/4	22716			
	5	BL 5.00/5	22726			
	6	BL 5.00/6	22736			
	7	BL 5.00/7	22746			
	8	BL 5.00/8	22756			
	9	BL 5.00/9	22766			
	10	BL 5.00/10	22776			
	11	BL 5.00/11	22786			
	12	BL 5.00/12	22796			
	13	BL 5.00/13	22806			
	14	BL 5.00/14	22816			
	15	BL 5.00/15	22826			

Note: Plugs and headers are supplied with orange moldings. Alternate colors are available upon request. * See pages 6/76-80 for locking blocks and other accessories.

SL 90 90° Header with open ends

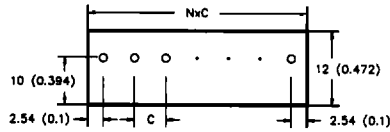
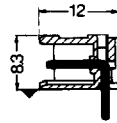

SL 90 B 90° Header with closed ends

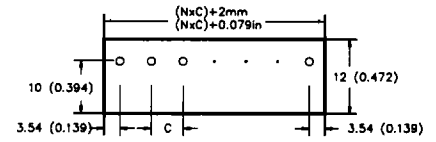
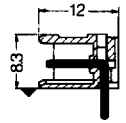

Header	Poles	Type	Cat. No.	Poles	Type	Cat. No.
Pitch (C)	5.08 mm (.200 in)			5.08 mm (.200 in)		
	2	SL 5.08/90/2	11266			
	3	SL 5.08/90/3	11256			
	4	SL 5.08/90/4	11246	4	SL 5.08/90/4B	123496
	5	SL 5.08/90/5	11236	5	SL 5.08/90/5B	123506
	6	SL 5.08/90/6	11226	6	SL 5.08/90/6B	123516
	7	SL 5.08/90/7	11216	7	SL 5.08/90/7B	123526
	8	SL 5.08/90/8	11206	8	SL 5.08/90/8B	123536
	9	SL 5.08/90/9	11196	9	SL 5.08/90/9B	123546
	10	SL 5.08/90/10	11186	10	SL 5.08/90/10B	123556
	11	SL 5.08/90/11	11176	11	SL 5.08/90/11B	123566
	12	SL 5.08/90/12	11166	12	SL 5.08/90/12B	123576
	13	SL 5.08/90/13	11156	13	SL 5.08/90/13B	123586
	14	SL 5.08/90/14	11146	14	SL 5.08/90/14B	123596
	15	SL 5.08/90/15	69236	15	SL 5.08/90/15B	123606
Pitch (C)	5.00 mm (.197 in)					
	2	SL 5.00/90/2	22976			
	3	SL 5.00/90/3	22966			
	4	SL 5.00/90/4	22956			
	5	SL 5.00/90/5	23006			
	6	SL 5.00/90/6	23016			
	7	SL 5.00/90/7	23026			
	8	SL 5.00/90/8	23036			
	9	SL 5.00/90/9	23046			
	10	SL 5.00/90/10	23056			
	11	SL 5.00/90/11	23066			
	12	SL 5.00/90/12	23076			
	13	SL 5.00/90/13	23086			
	14	SL 5.00/90/14	23096			
	15	SL 5.00/90/15	23106			

Note: Plugs and headers are supplied with orange moldings. Alternate colors are available upon request.

* See pages 6/76-80 for locking blocks and other accessories.

Printed Circuit Board Connectors
BL/SL Series
5.08/5.00 mm Pitch

SL 180 180° Header with open ends

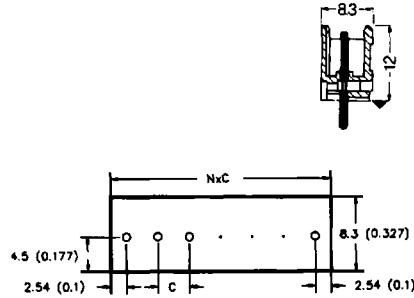

SL 180 B 180° Header with closed ends

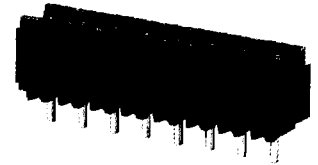
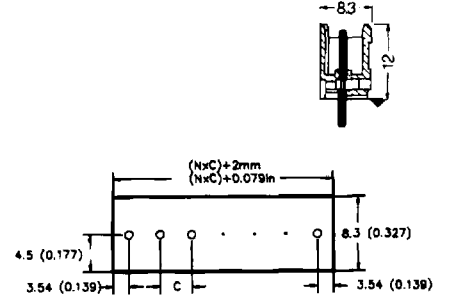

	Poles	Type	Cat. No.	Poles	Type	Cat. No.
Pitch (C)	5.08 mm (.200 in)			5.08 mm (.200 in)		
	2	SL 5.08/180/2	11136			
	3	SL 5.08/180/3	11126			
	4	SL 5.08/180/4	11116	4	SL 5.08/180/4B	123636
	5	SL 5.08/180/5	11106	5	SL 5.08/180/5B	123646
	6	SL 5.08/180/6	11096	6	SL 5.08/180/6B	123656
	7	SL 5.08/180/7	11086	7	SL 5.08/180/7B	123666
	8	SL 5.08/180/8	11076	8	SL 5.08/180/8B	123676
	9	SL 5.08/180/9	11066	9	SL 5.08/180/9B	123686
	10	SL 5.08/180/10	11056	10	SL 5.08/180/10B	123696
	11	SL 5.08/180/11	11046	11	SL 5.08/180/11B	123706
	12	SL 5.08/180/12	11036	12	SL 5.08/180/12B	123716
	13	SL 5.08/180/13	11026	13	SL 5.08/180/13B	123726
	14	SL 5.08/180/14	11016	14	SL 5.08/180/14B	123736
	15	SL 5.08/180/15	69226	15	SL 5.08/180/15B	123746
Pitch (C)	5.00 mm (.197 in)					
	2	SL 5.00/180/2	22836			
	3	SL 5.00/180/3	22846			
	4	SL 5.00/180/4	22856			
	5	SL 5.00/180/5	22866			
	6	SL 5.00/180/6	22876			
	7	SL 5.00/180/7	22886			
	8	SL 5.00/180/8	22896			
	9	SL 5.00/180/9	22906			
	10	SL 5.00/180/10	22916			
	11	SL 5.00/180/11	22926			
	12	SL 5.00/180/12	22936			
	13	SL 5.00/180/13	22946			
	14	SL 5.00/180/14	22956			
	15	SL 5.00/180/15	22966			

Note: Plugs and headers are supplied with orange moldings. Alternate colors are available upon request. * See pages 6/76-80 for locking blocks and other accessories.

Printed Circuit Board Connectors
MHSV 1
Universal Plug System

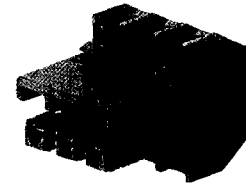
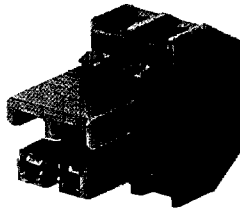

Materials Data	
Insulating material	Polyamide
Color	orange
Contact parts	CuZn
Surface	1 μm Au
Contact spring	ST
Surface	ZnCo
Dimensions	
Contact type	hermaphroditic
Number of poles	2...3
Pitch	mm 5
Stripping length	mm 8
Binding screw	M 2
Torque	Nm 0.25
Plug-in force/pin	N ≥4.4
Separation force/pin	N ≥4.2
Plugging frequency	≥100
Protection class	IP20

Rated Data	VDE	UL	CSA
Wire size	1.5 mm ²	#28...16 AWG	#28...16 AWG
Rated current	2 A	2 A	2 A
Rated voltage			
Insulation group C	250 VAC	300VAC	300VAC
Insulation group R	380 VAC		

Ordering Data

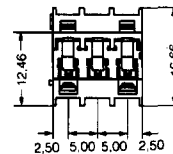
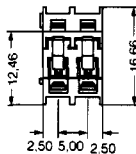
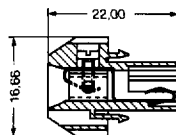

Poles	Type	Cat. No.	Poles	Type	Cat. No.
2	MHSV 1/2	950952	3	MHSV 1/3	950953

when inserted

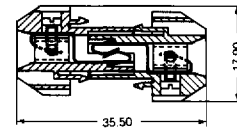

Front panel mounting Front panel cut-out

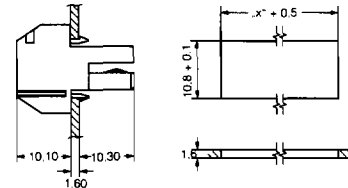

Front panel thickness 1.6mm
 x = connector length
 x = (n x 5) mm N = Number of pins
 (when using 2 cover plates + 2.8mm)

Printed circuit board layout

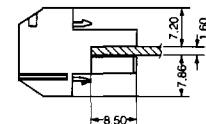

Printed circuit board thickness 1.6mm
 Pitch 5mm

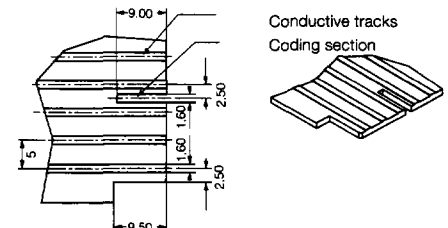

Printed circuit board cut-outs for coding pins and cover plates. We recommend the use of coding pins and cover plates for correct positioning on the circuit board. Coding pins cannot be used at the beginning or the end of a 2-pin or 3-pin plug unit.

*Other colors available upon request.

**Printed Circuit Board Connector
with Screw Connection
per DIN 41 612
UESD B32/UESD S32**

UESD S32/180

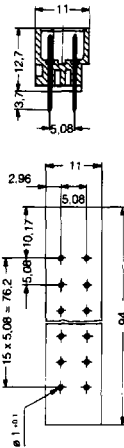

UESD S32/90

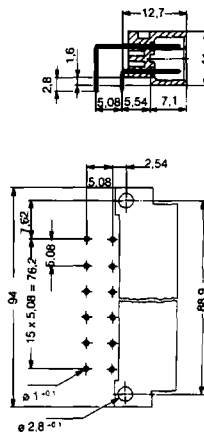

UESD B32

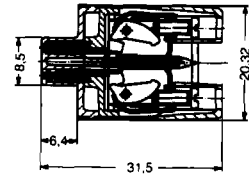

Materials Data	
Insulating material	PBT fiberglass-reinforced
Color	orange*
Temperature range	°C -55...+120
Flammability rating	UL 94 VO
Contact base material	CuSn
Contact surface	Gold-plated
TOP 1.5 K-Connection	Steel
Dimensions	
Pitch	mm 5.08
Clearance	mm ≥ 3.4 (S32) ≥4.0 (B32)
Leaking distance	mm ≥ 3.4 (S32) ≥4.0 (B32)
Connection method	screw connection
Solder pin length	mm 2.8 (S32/90°)
	mm 3.7 (S32/180°)
Component hole	Ø mm 1.0+0.1
Clamping screw	M 2.5
Insulation resistance	M Ω ≥ 10 ⁵
Current-flow resistance	m Ω ≤ 11
Plug cycles	≤ 400

Rated Data	UL	CSA
Rated voltage, industrial/commercial	VAC 300	300
Rated current	A 6	4
Wire size	AWG #24...16	#24...16

Rated Values per VDE	
Rated cross section	mm ² 1.5
Rated current	A 6
Current capacity	see derating curve [†]
Rated voltage	VAC 250, Group C (B32)
	VAC 125, Group C (S32)
Test voltage	kV 1.55
Test torque/rated torque	Nm 0.4

For 19" electronic measurement and control modules, Eurocards with connectors per DIN 41612.

The 32-pin Weidmüller connector per DIN 41612 consists of the UESD B32 socket with a Weidmüller TOP 1.5 K screw connection element as well as the UESD S32/90° and 180° header. It is ideally suited for use as a releasable screw-type connector for components in 19" plug-in modules.

Features:

- screw connection for DIN 41612, Model D
- latest screw connection technology using TOP 1.5K
- wire entry and screw on same surface
- surface of contacts adjusted to function, gold-plated contact area, tin-plated solder area.

Derating curve

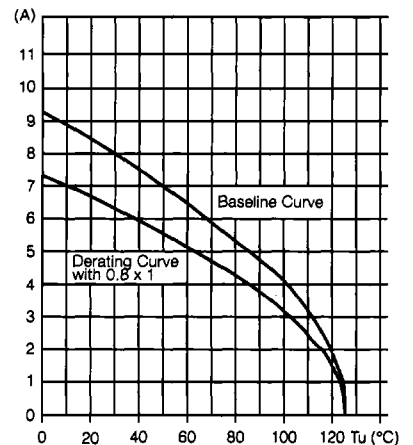

UESD B32 with UESD S32/90 , H07V-K 1.5 mm²

Poles	Type	Cat. No.
32	UESD B32 OG	157758
32	UESD S32/90 OG	159625
32	UESD S32/180 OG	159626

* Additional colors available on request

**Conductor insulation diameter < 3.3mm

†Additional derating curves available on request

***Depending on wire and ferrule used