

## Transistors

# -500mA / -12V Low $V_{CE}$ (sat) Digital transistors (with built-in resistors)

## DTB543ZE / DTB543ZM

### ●Applications

Inverter, Interface, Driver

### ●Feature

- 1)  $V_{CE}$  (sat) is lower than conventional products.
- 2) Built-in bias resistors enable the configuration of an inverter circuit without connecting external input resistors (see equivalent circuit).
- 3) The bias resistors consist of thin-film resistors with complete isolation to allow positive biasing of the input. They also have the advantage of almost completely eliminating parasitic effects.
- 4) Only the on / off conditions need to be set for operation, making the device design easy.

### ●Structure

PNP epitaxial planar silicon transistor  
(Resistor built-in type)

### ●Dimensions (Unit : mm)

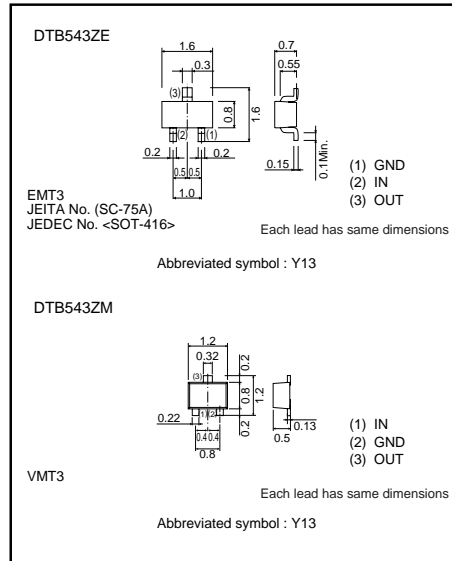

### ●Absolute maximum ratings ( $T_a=25^\circ\text{C}$ )

Parameter	Symbol	Limits		Unit
		DTB543ZE	DTB543ZM	
Supply voltage	$V_{CC}$	-12		V
Input voltage	$V_{IN}$	-12 to +5		V
Collector current *1	$I_C$ (max)	-500		mA
Power dissipation *2	$P_D$	150		mW
Junction temperature	$T_J$	150		$^\circ\text{C}$
Storage temperature	$T_{stg}$	-55 to +150		$^\circ\text{C}$

\*1 Characteristics of built-in transistor.

\*2 Each terminal mounted on a recommended land.

### ●Packaging specifications

Part No.	Package	EMT3	VMT3
	Packaging type	Taping	Taping
	Code	TL	T2L
	Basic ordering unit (pieces)	3000	8000
DTB543ZE		○	-
DTB543ZM		-	○

### ●Electrical characteristics ( $T_a=25^\circ\text{C}$ )

Parameter	Symbol	Min.	Typ.	Max.	Unit	Conditions
Input voltage	$V_{(off)}$	-	-	-0.3	V	$V_{CC}=-5\text{V}$ , $I_{O}=-100\mu\text{A}$
	$V_{(on)}$	-2.5	-	-		$V_{O}=-0.3\text{V}$ , $I_{O}=-20\text{mA}$
Output voltage	$V_{O(on)}$	-	-60	-300	mV	$I_{O}/I_{I}=-100\text{mA} / -5\text{mA}$
Input current	$I_I$	-	-	-1.4	mA	$V_I=-5\text{V}$
Output current	$I_{O(off)}$	-	-	-0.5	$\mu\text{A}$	$V_{CC}=-12\text{V}$ , $V_I=0\text{V}$
DC current gain	$G_I$	140	-	-	-	$V_{O}=-2\text{V}$ , $I_{O}=-100\text{mA}$
Transition frequency *	$f_T$	-	260	-	MHz	$V_{CE}=-10\text{V}$ , $I_E=5\text{mA}$ , $f=100\text{MHz}$
Input resistance	$R_1$	3.29	4.7	6.11	k $\Omega$	-
Resistance ratio	$R_2/R_1$	8.0	10	12	-	-

\* Characteristics of built-in transistor.

### ●Equivalent circuit

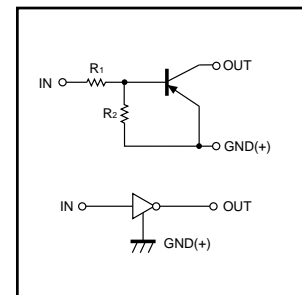

$R_1=4.7\text{k}\Omega$  /  $R_2=47\text{k}\Omega$

Transistors

●Electrical characteristic curves

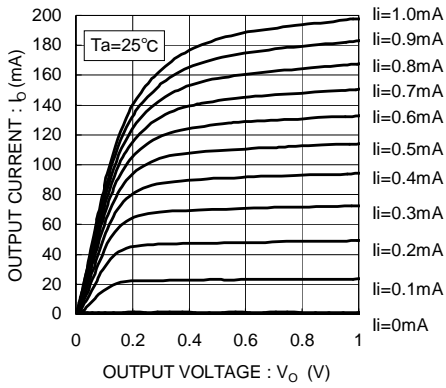

Fig.1 Output Current vs. Output Voltage

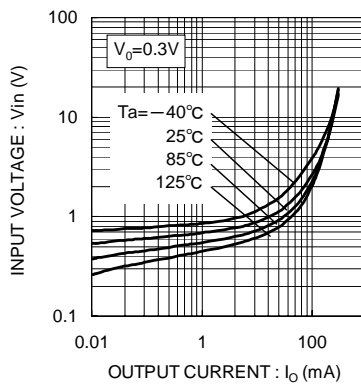

Fig.2 Input Voltage vs. Output Current

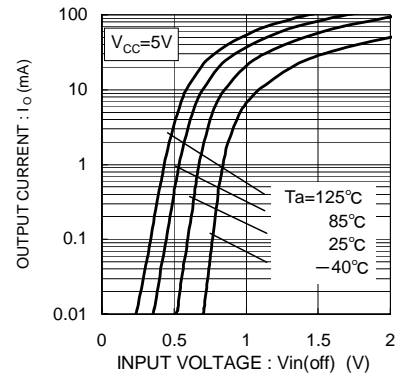

Fig.3 Output Current vs. Input Voltage

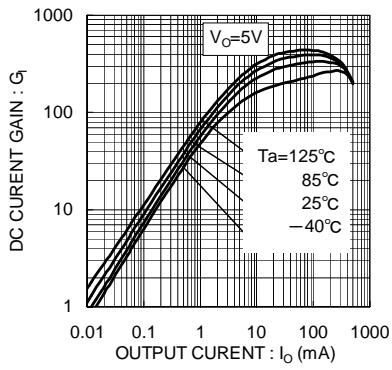

Fig.4 DC Current Gain vs. Output Current

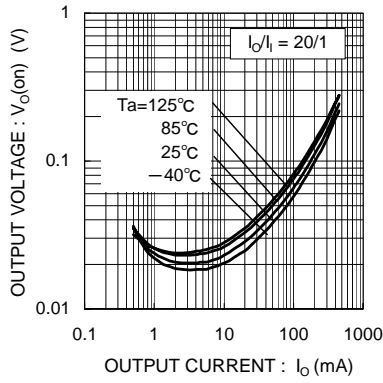

Fig.5 Output Voltage vs. Output Current

### Notes

- No technical content pages of this document may be reproduced in any form or transmitted by any means without prior permission of ROHM CO.,LTD.
- The contents described herein are subject to change without notice. The specifications for the product described in this document are for reference only. Upon actual use, therefore, please request that specifications to be separately delivered.
- Application circuit diagrams and circuit constants contained herein are shown as examples of standard use and operation. Please pay careful attention to the peripheral conditions when designing circuits and deciding upon circuit constants in the set.
- Any data, including, but not limited to application circuit diagrams information, described herein are intended only as illustrations of such devices and not as the specifications for such devices. ROHM CO.,LTD. disclaims any warranty that any use of such devices shall be free from infringement of any third party's intellectual property rights or other proprietary rights, and further, assumes no liability of whatsoever nature in the event of any such infringement, or arising from or connected with or related to the use of such devices.
- Upon the sale of any such devices, other than for buyer's right to use such devices itself, resell or otherwise dispose of the same, no express or implied right or license to practice or commercially exploit any intellectual property rights or other proprietary rights owned or controlled by
- ROHM CO., LTD. is granted to any such buyer.
- Products listed in this document are no antiradiation design.

The products listed in this document are designed to be used with ordinary electronic equipment or devices (such as audio visual equipment, office-automation equipment, communications devices, electrical appliances and electronic toys).

Should you intend to use these products with equipment or devices which require an extremely high level of reliability and the malfunction of which would directly endanger human life (such as medical instruments, transportation equipment, aerospace machinery, nuclear-reactor controllers, fuel controllers and other safety devices), please be sure to consult with our sales representative in advance.

It is our top priority to supply products with the utmost quality and reliability. However, there is always a chance of failure due to unexpected factors. Therefore, please take into account the derating characteristics and allow for sufficient safety features, such as extra margin, anti-flammability, and fail-safe measures when designing in order to prevent possible accidents that may result in bodily harm or fire caused by component failure. ROHM cannot be held responsible for any damages arising from the use of the products under conditions out of the range of the specifications or due to non-compliance with the NOTES specified in this catalog.

Thank you for your accessing to ROHM product informations.

More detail product informations and catalogs are available, please contact your nearest sales office.

**ROHM** Customer Support System

THE AMERICAS / EUROPE / ASIA / JAPAN

[www.rohm.com](http://www.rohm.com)

Contact us : [webmaster@rohm.co.jp](mailto:webmaster@rohm.co.jp)