

## DDR2 Unbuffered SODIMM

200pin Unbuffered SODIMM based on 1Gb A-die  
64-bit Non-ECC

**68FBGA & 84FBGA with Pb-Free**  
**(RoHS compliant)**

INFORMATION IN THIS DOCUMENT IS PROVIDED IN RELATION TO SAMSUNG PRODUCTS,  
AND IS SUBJECT TO CHANGE WITHOUT NOTICE.

NOTHING IN THIS DOCUMENT SHALL BE CONSTRUED AS GRANTING ANY LICENSE,  
EXPRESS OR IMPLIED, BY ESTOPPEL OR OTHERWISE,

TO ANY INTELLECTUAL PROPERTY RIGHTS IN SAMSUNG PRODUCTS OR TECHNOLOGY. ALL  
INFORMATION IN THIS DOCUMENT IS PROVIDED

ON AS "AS IS" BASIS WITHOUT GUARANTEE OR WARRANTY OF ANY KIND.

1. For updates or additional information about Samsung products, contact your nearest Samsung office.
2. Samsung products are not intended for use in life support, critical care, medical, safety equipment, or similar applications where Product failure could result in loss of life or personal or physical harm, or any military or defense application, or any governmental procurement to which special terms or provisions may apply.

\* Samsung Electronics reserves the right to change products or specification without notice.

## Table of Contents

<b>1.0 DDR2 Unbuffered DIMM Ordering Information</b> .....	<b>4</b>
<b>2.0 Features</b> .....	<b>4</b>
<b>3.0 Address Configuration</b> .....	<b>4</b>
<b>4.0 Pin Configurations (Front side/Back side)</b> .....	<b>5</b>
<b>5.0 Pin Description</b> .....	<b>5</b>
<b>6.0 Input/Output Function Description</b> .....	<b>6</b>
<b>7.0 Functional Block Diagram :</b> .....	<b>7</b>
7.1 1GB, 128Mx64 Module - M470T2864AZ3 .....	7
7.2 512MB, 64Mx64 Module - M470T6464AZ3 .....	8
7.3 2GB, 256Mx64 Module - M470T5669AZ0 .....	9
<b>8.0 Absolute Maximum DC Ratings</b> .....	<b>10</b>
<b>9.0 AC &amp; DC Operating Conditions</b> .....	<b>10</b>
9.1 Recommended DC Operating Conditions (SSTL - 1.8) .....	10
9.2 Operating Temperature Condition .....	11
9.3 Input DC Logic Level .....	11
9.4 Input AC Logic Level .....	11
9.5 AC Input Test Conditions .....	11
<b>10.0 IDD Specification Parameters Definition</b> .....	<b>12</b>
<b>11.0 Operating Current Table</b> .....	<b>13</b>
11.1 M470T2864AZ3 : 128Mx64 1GB Module.....	13
11.2 M470T6464AZ3: 64Mx64 512MB Module .....	13
11.3 M470T5669AZ0: 256Mx64 1GB Module .....	14
<b>12.0 Input/Output Capacitance</b> .....	<b>15</b>
<b>13.0 Electrical Characteristics &amp; AC Timing for DDR2-667/533/400</b> .....	<b>15</b>
13.1 Refresh Parameters by Device Density .....	15
13.2 Speed Bins and CL, tRCD, tRP, tRC and tRAS for Corresponding Bin .....	15
13.3 Timing Parameters by Speed Grade .....	16
<b>14.0 Physical Dimensions :</b> .....	<b>18</b>
14.1 64Mbx16 based 128Mx64 Module (2 Rank) - M470T2864AZ3 .....	18
14.2 64Mbx16 based 64Mx64 Module (1 Rank) - M470T6464AZ3 .....	19
14.3 st.256Mbx8 based 256Mx64 Module (2 Ranks) - M470T5669AZ0 .....	20

**Revision History**

Revision	Month	Year	History
1.0	July	2005	- Initial Release
1.1	August	2005	- Revised IDD Current Values
1.2	March	2006	- Revised Physical Dimensions for 2GB
1.3	September	2006	- Added the VddSPD values
1.4	March	2007	- Corrected the physical dimension

## 1.0 DDR2 Unbuffered DIMM Ordering Information

Part Number	Density	Organization	Component Composition	Number of Rank	Height
M470T6464AZ3-C(L)E6/D5/CC	512MB	64Mx64	64Mx16 (K4T1G164QA-C(L)E6/D5/CC)*4	1	30mm
M470T2864AZ3-C(L)E6/D5/CC	1GB	128Mx64	64Mx16 (K4T1G164QA-C(L)E6/D5/CC)*8	2	30mm
M470T5669AZ0-C(L)E6/D5/CC	2GB	256Mx64	st.256Mx8 (K4T2G074QA-C(L)E6/D5/CC)*8	2	30mm

Note :

1. "Z" of Part number(11th digit) stand for Lead-free products.
2. "3" of Part number(12th digit) stand for Dummy Pad PCB products.

## 2.0 Features

- Performance range

	E6 (DDR2-667)	D5 (DDR2-533)	CC (DDR2-400)	Unit
Speed@CL3	400	400	400	Mbps
Speed@CL4	533	533	400	Mbps
Speed@CL5	667	533	-	Mbps
CL-tRCD-tRP	5-5-5	4-4-4	3-3-3	CK

- JEDEC standard 1.8V ± 0.1V Power Supply
- $V_{DDQ} = 1.8V \pm 0.1V$
- 200 MHz  $f_{CK}$  for 400Mb/sec/pin, 267MHz  $f_{CK}$  for 533Mb/sec/pin, 333MHz  $f_{CK}$  for 667Mb/sec/pin
- 8 Banks
- Posted  $\overline{CAS}$
- Programmable  $\overline{CAS}$  Latency: 3, 4, 5
- Programmable Additive Latency: 0, 1, 2, 3 and 4
- Write Latency(WL) = Read Latency(RL) -1
- Burst Length: 4, 8(Interleave/nibble sequential)
- Programmable Sequential / Interleave Burst Mode
- Bi-directional Differential Data-Strobe (Single-ended data-strobe is an optional feature)
- Off-Chip Driver(OCD) Impedance Adjustment
- On Die Termination with selectable values(50/75/150 ohms or disable)
- PASR(Partial Array Self Refresh)
- Average Refresh Period 7.8us at lower than a  $T_{CASE} 85^{\circ}C$ , 3.9us at  $85^{\circ}C < T_{CASE} \leq 95^{\circ}C$   
- support High Temperature Self-Refresh rate enable feature
- Package: 84ball FBGA - 64Mx16, 70ball FBGA - st.256Mx8
- All of Lead-free products are compliant for RoHS

Note : For detailed DDR2 SDRAM operation, please refer to Samsung's Device operation & Timing diagram.

## 3.0 Address Configuration

Organization	Row Address	Column Address	Bank Address	Auto Precharge
128Mx8(1Gb) based Module	A0-A13	A0-A9	BA0-BA2	A10
64Mx16(1Gb) based Module	A0-A12	A0-A9	BA0-BA2	A10

## 4.0 Pin Configurations (Front side/Back side)

Pin	Front	Pin	Back	Pin	Front	Pin	Back	Pin	Front	Pin	Back	Pin	Front	Pin	Back
1	V <sub>REF</sub>	2	V <sub>SS</sub>	51	DQS2	52	DM2	101	A1	102	A0	151	DQ42	152	DQ46
3	V <sub>SS</sub>	4	DQ4	53	V <sub>SS</sub>	54	V <sub>SS</sub>	103	V <sub>DD</sub>	104	V <sub>DD</sub>	153	DQ43	154	DQ47
5	DQ0	6	DQ5	55	DQ18	56	DQ22	105	A10/AP	106	BA1	155	V <sub>SS</sub>	156	V <sub>SS</sub>
7	DQ1	8	V <sub>SS</sub>	57	DQ19	58	DQ23	107	BA0	108	RAS	157	DQ48	158	DQ52
9	V <sub>SS</sub>	10	DM0	59	V <sub>SS</sub>	60	V <sub>SS</sub>	109	WE	110	$\overline{S0}$	159	DQ49	160	DQ53
11	$\overline{DQS0}$	12	V <sub>SS</sub>	61	DQ24	62	DQ28	111	V <sub>DD</sub>	112	V <sub>DD</sub>	161	V <sub>SS</sub>	162	V <sub>SS</sub>
13	DQS0	14	DQ6	63	DQ25	64	DQ29	113	CAS	114	ODT0	163	NC, TEST	164	CK1
15	V <sub>SS</sub>	16	DQ7	65	V <sub>SS</sub>	66	V <sub>SS</sub>	115	NC/ $\overline{S1}$	116	A13	165	V <sub>SS</sub>	166	$\overline{CK1}$
17	DQ2	18	V <sub>SS</sub>	67	DM3	68	$\overline{DQS3}$	117	VDD	118	V <sub>DD</sub>	167	$\overline{DQS6}$	168	V <sub>SS</sub>
19	DQ3	20	DQ12	69	NC	70	DQS3	119	NC/ODT1	120	NC	169	DQS6	170	DM6
21	V <sub>SS</sub>	22	DQ13	71	V <sub>SS</sub>	72	V <sub>SS</sub>	121	V <sub>SS</sub>	122	V <sub>SS</sub>	171	V <sub>SS</sub>	172	V <sub>SS</sub>
23	DQ8	24	V <sub>SS</sub>	73	DQ26	74	DQ30	123	DQ32	124	DQ36	173	DQ50	174	DQ54
25	DQ9	26	DM1	75	DQ27	76	DQ31	125	DQ33	126	DQ37	175	DQ51	176	DQ55
27	V <sub>SS</sub>	28	V <sub>SS</sub>	77	V <sub>SS</sub>	78	V <sub>SS</sub>	127	V <sub>SS</sub>	128	V <sub>SS</sub>	177	V <sub>SS</sub>	178	V <sub>SS</sub>
29	$\overline{DQS1}$	30	CK0	79	CKE0	80	NC/CKE1	129	$\overline{DQS4}$	130	DM4	179	DQ56	180	DQ60
31	DQS1	32	$\overline{CK0}$	81	V <sub>DD</sub>	82	V <sub>DD</sub>	131	DQS4	132	V <sub>SS</sub>	181	DQ57	182	DQ61
33	V <sub>SS</sub>	34	V <sub>SS</sub>	83	NC	84	NC	133	V <sub>SS</sub>	134	DQ38	183	V <sub>SS</sub>	184	V <sub>SS</sub>
35	DQ10	36	DQ14	85	BA2	86	NC	135	DQ34	136	DQ39	185	DM7	186	$\overline{DQS7}$
37	DQ11	38	DQ15	87	V <sub>DD</sub>	88	V <sub>DD</sub>	137	DQ35	138	V <sub>SS</sub>	187	V <sub>SS</sub>	188	DQS7
39	V <sub>SS</sub>	40	V <sub>SS</sub>	89	A12	90	A11	139	V <sub>SS</sub>	140	DQ44	189	DQ58	190	V <sub>SS</sub>
41	V <sub>SS</sub>	42	V <sub>SS</sub>	91	A9	92	A7	141	DQ40	142	DQ45	191	DQ59	192	DQ62
43	DQ16	44	DQ20	93	A8	94	A6	143	DQ41	144	V <sub>SS</sub>	193	V <sub>SS</sub>	194	DQ63
45	DQ17	46	DQ21	95	V <sub>DD</sub>	96	V <sub>DD</sub>	145	V <sub>SS</sub>	146	$\overline{DQS5}$	195	SDA	196	V <sub>SS</sub>
47	V <sub>SS</sub>	48	V <sub>SS</sub>	97	A5	98	A4	147	DM5	148	DQS5	197	SCL	198	SA0
49	$\overline{DQS2}$	50	NC	99	A3	100	A2	149	V <sub>SS</sub>	150	V <sub>SS</sub>	199	V <sub>DD</sub> SPD	200	SA1

Note : NC = No Connect; NC, TEST(pin 163)is for bus analysis tool and is not connected on normal memory modules.

## 5.0 Pin Description

Pin Name	Description	Pin Name	Description
CK0,CK1	Clock Inputs, positive line	SDA	SPD Data Input/Output
$\overline{CK0},\overline{CK1}$	Clock Inputs, negative line	SA1,SA0	SPD address
CKE0,CKE1	Clock Enables	DQ0~DQ63	Data Input/Output
$\overline{RAS}$	Row Address Strobe	DM0~DM7	Data Masks
$\overline{CAS}$	Column Address Strobe	DQS0~DQS7	Data strobes
$\overline{WE}$	Write Enable	$\overline{DQS0}\sim\overline{DQS7}$	Data strobes complement
$\overline{S0},\overline{S1}$	Chip Selects	TEST	Logic Analyzer specific test pin (No connect on So-DIMM)
A0~A9, A11~A13	Address Inputs	V <sub>DD</sub>	Core and I/O Power
A10/AP	Address Input/Autoprecharge	V <sub>SS</sub>	Ground
BA0~BA2	SDRAM Bank Address	V <sub>REF</sub>	Input/Output Reference
ODT0,ODT1	On-die termination control	V <sub>DD</sub> SPD	SPD Power
SCL	Serial Presence Detect (SPD) Clock Input	NC	Spare pins, No connect
CK0,CK1	Clock Inputs, positive line	SDA	SPD Data Input/Output

\*The VDD and VDDQ pins are tied to the single power-plane on PCB.

## 6.0 Input/Output Function Description

Symbol	Type	Description
$\overline{CK0-CK1}$ $CK0-CK1$	Input	The system clock inputs. All address and command lines are sampled on the cross point of the rising edge of CK and falling edge of $\overline{CK}$ . A Delay Locked Loop (DLL) circuit is driven from the clock input and output timing for read operations is synchronized to the input clock.
CKE0-CKE1	Input	Activates the DDR2 SDRAM CK signal when high and deactivates the CK signal when low. By deactivating the clocks, CKE low initiates the Power Down mode or the Self Refresh mode.
$\overline{S0-S1}$	Input	Enables the associated DDR2 SDRAM command decoder when low and disables the command decoder when high. When the command decoder is disabled, new commands are ignored but previous operations continue. Rank 0 is selected by $\overline{S0}$ , Rank 1 is selected by $\overline{S1}$ . Ranks are also called "Physical banks".
$\overline{RAS}$ , $\overline{CAS}$ , $\overline{WE}$	Input	When sampled at the cross point of the rising edge of CK and falling edge of $\overline{CK}$ , $\overline{CAS}$ , $\overline{RAS}$ , and $\overline{WE}$ define the operation to be executed by the SDRAM.
BA0~BA2	Input	Selects which DDR2 SDRAM internal bank is activated.
ODT0~ODT1	Input	Asserts on-die termination for DQ, DM, DQS, and $\overline{DQS}$ signals if enabled via the DDR2 SDRAM Extended Mode Register Set (EMRS).
A0~A9, A10/AP, A11~A13	Input	During a Bank Activate command cycle, defines the row address when sampled at the cross point of the rising edge of CK and falling edge of $\overline{CK}$ . During a Read or Write command cycle, defines the column address when sampled at the cross point of the rising edge of CK and falling edge of $\overline{CK}$ . In addition to the column address, AP is used to invoke autoprecharge operation at the end of the burst read or write cycle. If AP is high, autoprecharge is selected and BA0-BAn defines the bank to be precharged. If AP is low, autoprecharge is disabled. During a Precharge command cycle, AP is used in conjunction with BA0-BAn to control which bank(s) to precharge. If AP is high, all banks will be precharged regardless of the state of BA0-BAn inputs. If AP is low, then BA0-BAn are used to define which bank to precharge.
DQ0~DQ63	In/Out	Data Input/Output pins.
DM0~DM7	Input	The data write masks, associated with one data byte. In Write mode, DM operates as a byte mask by allowing input data to be written if it is low but blocks the write operation if it is high. In Read mode, DM lines have no effect.
$\overline{DQS0}\sim\overline{DQS7}$ $DQS0\sim DQS7$	In/Out	The data strobes, associated with one data byte, sourced with data transfers. In Write mode, the data strobe is sourced by the controller and is centered in the data window. In Read mode, the data strobe is sourced by the DDR2 SDRAMs and is sent at the leading edge of the data window. $\overline{DQS}$ signals are complements, and timing is relative to the crosspoint of respective DQS and $\overline{DQS}$ . If the module is to be operated in single ended strobe mode, all $\overline{DQS}$ signals must be tied on the system board to VSS and DDR2 SDRAM mode registers programmed appropriately.
$V_{DD}$ , $V_{DD}$ SPD, $V_{SS}$	Supply	Power supplies for core, I/O, Serial Presence Detect, and ground for the module.
SDA	In/Out	This is a bidirectional pin used to transfer data into or out of the SPD EEPROM. A resistor must be connected to $V_{DD}$ to act as a pull up.
SCL	Input	This signal is used to clock data into and out of the SPD EEPROM. A resistor may be connected from SCL to $V_{DD}$ to act as a pull up.
SA0~SA1	Input	Address pins used to select the Serial Presence Detect base address.
TEST	In/Out	The TEST pin is reserved for bus analysis tools and is not connected on normal memory modules(SO-DIMMs).

7.0 Functional Block Diagram :

7.1 1GB, 128Mx64 Module - M470T2864AZ3

(Populated as 2 rank of x16 DDR2 SDRAMs)

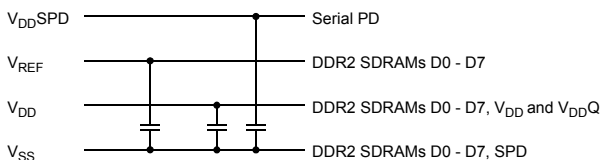
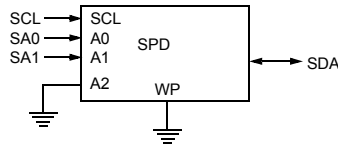
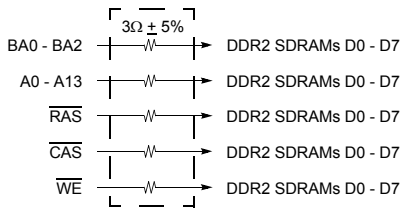
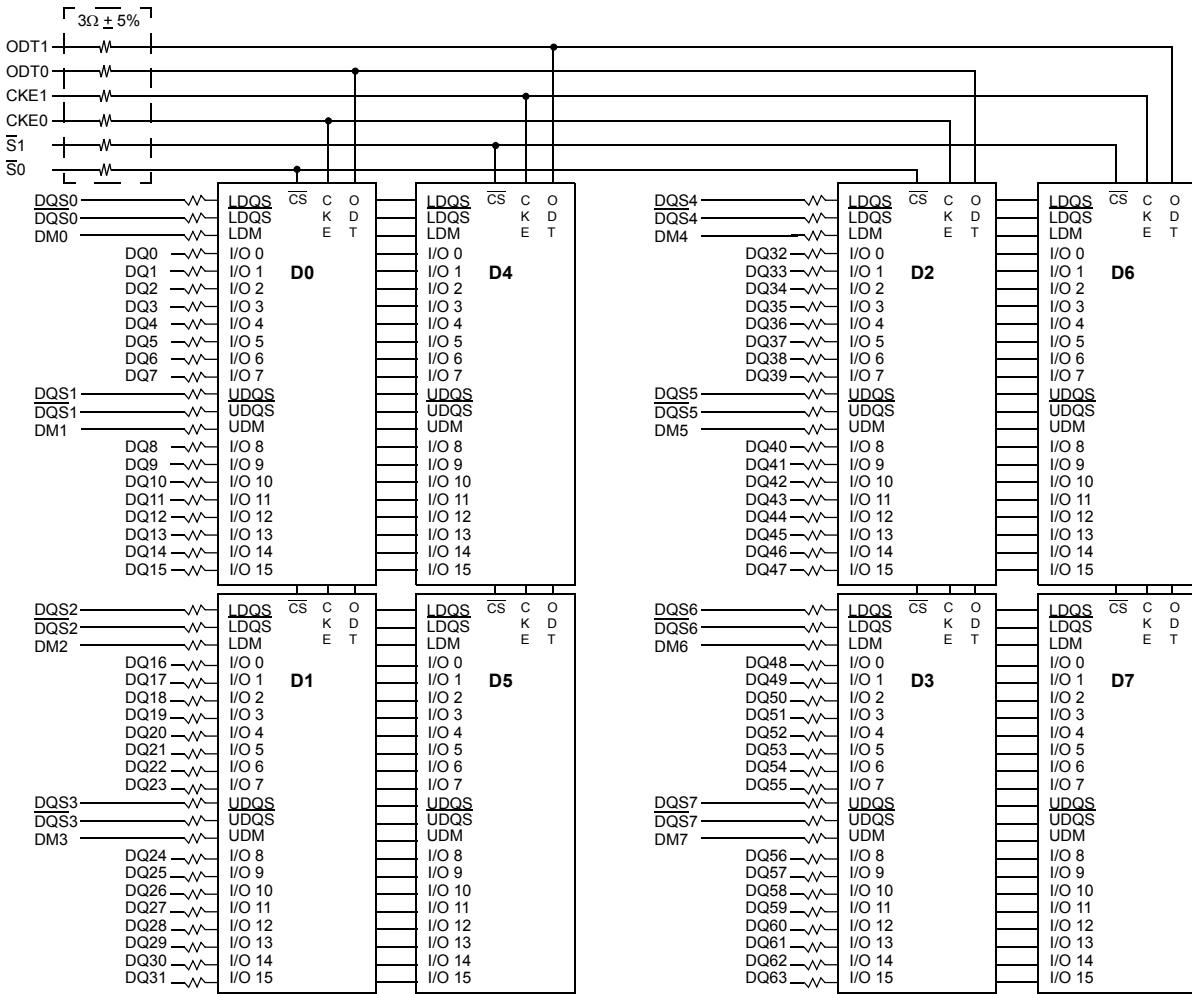

* Clock Wiring	
Clock Input	DDR2 SDRAMs
*CK0/CK0	4 DDR2 SDRAMs
*CK1/CK1	4 DDR2 SDRAMs

\* Wire per Clock Loading Table/Wiring Diagrams

Note :

1. DQ,DM, DQS/DQS resistors : 22 Ohms ± 5%.
2. BAx, Ax, RAS, CAS, WE resistors : 3.0 Ohms ± 5%.

7.2 512MB, 64Mx64 Module - M470T6464AZ3

(Populated as 1 rank of x16 DDR2 SDRAMs)

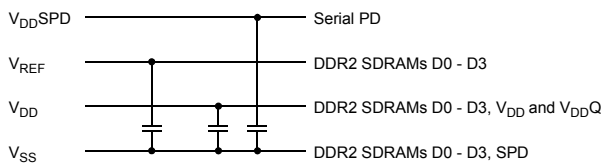
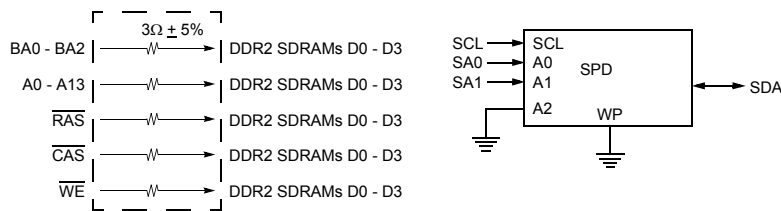
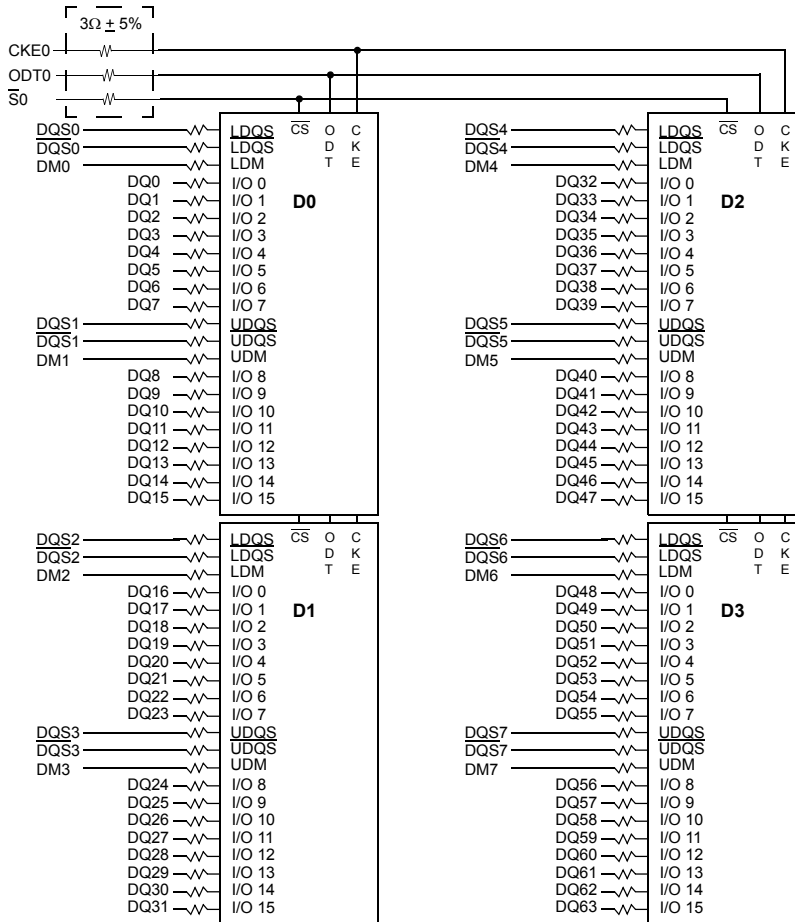

* Clock Wiring	
Clock Input	DDR2 SDRAMs
*CK0/ $\overline{\text{CK0}}$	2 DDR2 SDRAMs
*CK1/ $\overline{\text{CK1}}$	2 DDR2 SDRAMs

\* Wire per Clock Loading Table/Wiring Diagrams

Note :

1. DQ,DM,  $\overline{\text{DQS}}/\overline{\text{DQS}}$  resistors : 22 Ohms  $\pm 5\%$ .
2. BAx, Ax,  $\overline{\text{RAS}}$ ,  $\overline{\text{CAS}}$ ,  $\overline{\text{WE}}$  resistors : 3.0 Ohms  $\pm 5\%$ .



7.3 2GB, 256Mx64 Module - M470T5669AZ0

(Populated as 2 ranks of x8 DDR2 SDRAMs)

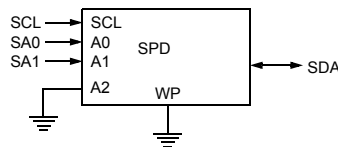
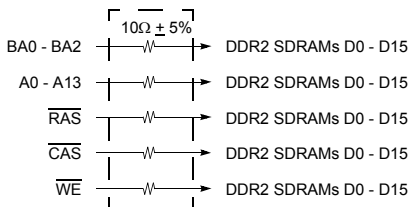
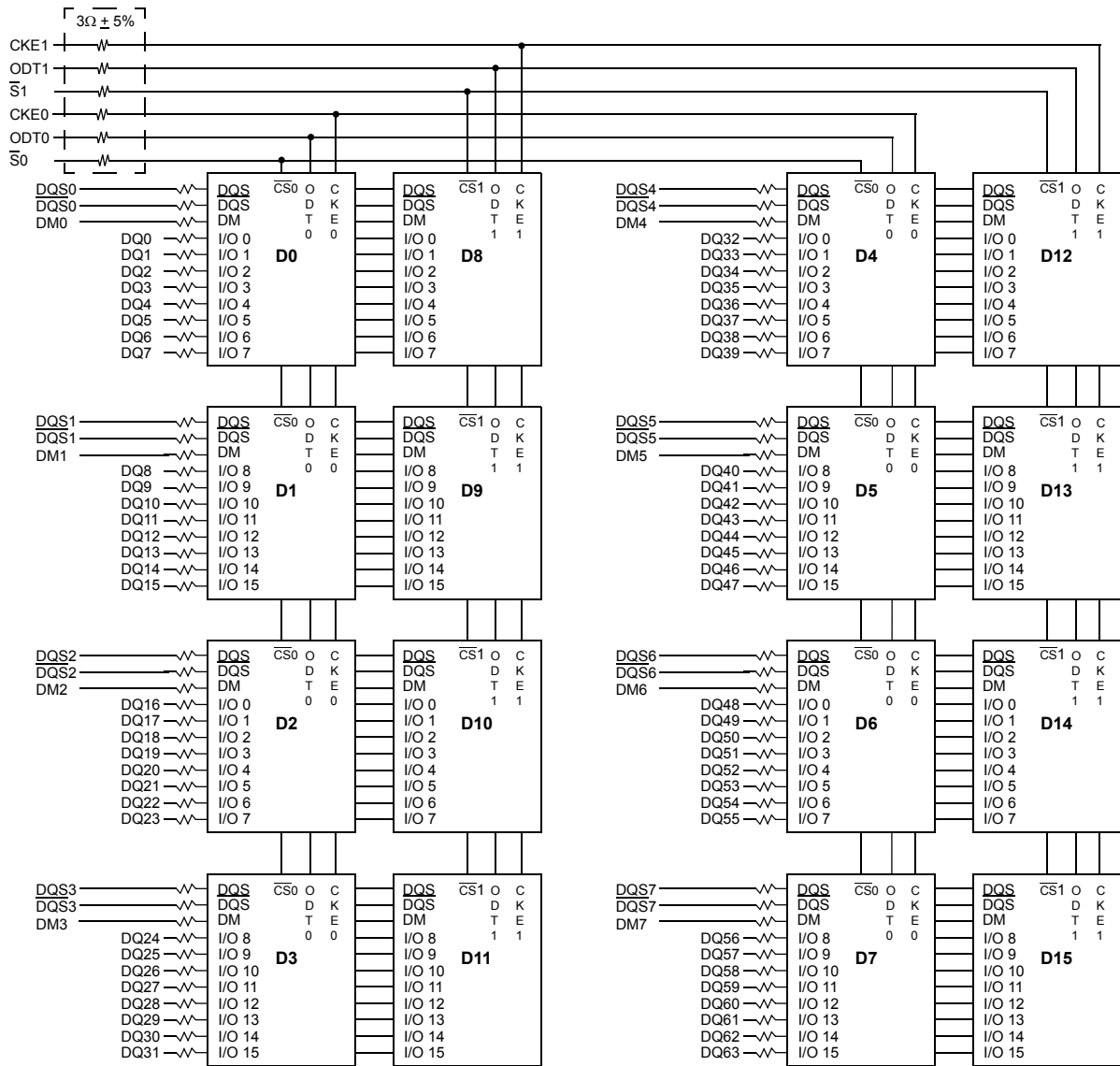

* Clock Wiring	
Clock Input	DDR2 SDRAMs
*CK0/CK0	8 DDR2 SDRAMs
*CK1/CK1	8 DDR2 SDRAMs

\* Wire per Clock Loading Table/Wiring Diagrams

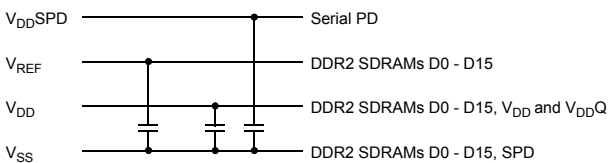

- Note :
1. DQ,DM,  $\overline{DQS}/\overline{DQS}$  resistors : 22 Ohms  $\pm$  5%.
  2. BAx, Ax, RAS, CAS, WE resistors : 10.0 Ohms  $\pm$  5%.

## 8.0 Absolute Maximum DC Ratings

Symbol	Parameter	Rating	Units	Notes
$V_{DD}$	Voltage on $V_{DD}$ pin relative to $V_{SS}$	- 1.0 V ~ 2.3 V	V	1
$V_{DDQ}$	Voltage on $V_{DDQ}$ pin relative to $V_{SS}$	- 0.5 V ~ 2.3 V	V	1
$V_{DDL}$	Voltage on $V_{DDL}$ pin relative to $V_{SS}$	- 0.5 V ~ 2.3 V	V	1
$V_{IN}, V_{OUT}$	Voltage on any pin relative to $V_{SS}$	- 0.5 V ~ 2.3 V	V	1
$T_{STG}$	Storage Temperature	-55 to +100	°C	1, 2

Note :

- Stresses greater than those listed under "Absolute Maximum Ratings" may cause permanent damage to the device. This is a stress rating only and functional operation of the device at these or any other conditions above those indicated in the operational sections of this specification is not implied. Exposure to absolute maximum rating conditions for extended periods may affect reliability.
- Storage Temperature is the case surface temperature on the center/top side of the DRAM. For the measurement conditions, please refer to JESD51-2 standard.

## 9.0 AC & DC Operating Conditions

### 9.1 Recommended DC Operating Conditions (SSTL - 1.8)

Symbol	Parameter	Rating			Units	Notes
		Min.	Typ.	Max.		
$V_{DD}$	Supply Voltage	1.7	1.8	1.9	V	
$V_{DDL}$	Supply Voltage for DLL	1.7	1.8	1.9	V	4
$V_{DDQ}$	Supply Voltage for Output	1.7	1.8	1.9	V	4
$V_{REF}$	Input Reference Voltage	$0.49 \cdot V_{DDQ}$	$0.50 \cdot V_{DDQ}$	$0.51 \cdot V_{DDQ}$	mV	1,2
$V_{TT}$	Termination Voltage	$V_{REF} - 0.04$	$V_{REF}$	$V_{REF} + 0.04$	V	3

Symbol	Parameter	Rating		Units	Notes
		Min.	Max.		
$V_{DDSPD}$	Core Supply Voltage	1.7	3.6	V	5

Note : There is no specific device  $V_{DD}$  supply voltage requirement for SSTL-1.8 compliance. However under all conditions  $V_{DDQ}$  must be less than or equal to  $V_{DD}$ .

- The value of  $V_{REF}$  may be selected by the user to provide optimum noise margin in the system. Typically the value of  $V_{REF}$  is expected to be about  $0.5 \times V_{DDQ}$  of the transmitting device and  $V_{REF}$  is expected to track variations in  $V_{DDQ}$ .
- Peak to peak AC noise on  $V_{REF}$  may not exceed  $\pm 2\% V_{REF(DC)}$ .
- $V_{TT}$  of transmitting device must track  $V_{REF}$  of receiving device.
- AC parameters are measured with  $V_{DD}$ ,  $V_{DDQ}$  and  $V_{DDL}$  tied together.
- SO-DIMMs that include an optional temperature sensor may require a restricted  $V_{DDSPD}$  operating voltage range for proper operation of the temperature sensor. Refer to the thermal sensor specification for details regarding the supported voltage range. All other functions of the SO-DIMM SPD are supported across the full  $V_{DDSPD}$  range.

9.2 Operating Temperature Condition

Symbol	Parameter	Rating	Units	Notes
TOPER	Operating Temperature	0 to 95	°C	1, 2, 3

Note :

1. Operating Temperature is the case surface temperature on the center/top side of the DRAM. For the measurement conditions, please refer to JESD51.2 standard.
2. At 85 - 95 °C operation temperature range, doubling refresh commands in frequency to a 32ms period ( tREFI=3.9 us ) is required, and to enter to self refresh mode at this temperature range, an EMRS command is required to change internal refresh rate.

9.3 Input DC Logic Level

Symbol	Parameter	Min.	Max.	Units	Notes
V <sub>IH</sub> (DC)	DC input logic high	V <sub>REF</sub> + 0.125	V <sub>DDQ</sub> + 0.3	V	
V <sub>IL</sub> (DC)	DC input logic low	- 0.3	V <sub>REF</sub> - 0.125	V	

9.4 Input AC Logic Level

Symbol	Parameter	DDR2-400, DDR2-533		DDR2-667		Units
		Min.	Max.	Min.	Max.	
V <sub>IH</sub> (AC)	AC input logic high	V <sub>REF</sub> + 0.250	-	V <sub>REF</sub> + 0.200		V
V <sub>IL</sub> (AC)	AC input logic low	-	V <sub>REF</sub> - 0.250		V <sub>REF</sub> - 0.200	V

9.5 AC Input Test Conditions

Symbol	Condition	Value	Units	Notes
V <sub>REF</sub>	Input reference voltage	0.5 * V <sub>DDQ</sub>	V	1
V <sub>SWING(MAX)</sub>	Input signal maximum peak to peak swing	1.0	V	1
SLEW	Input signal minimum slew rate	1.0	V/ns	2, 3

Note :

1. Input waveform timing is referenced to the input signal crossing through the V<sub>IH/IL</sub>(AC) level applied to the device under test.
2. The input signal minimum slew rate is to be maintained over the range from V<sub>REF</sub> to V<sub>IH</sub>(AC) min for rising edges and the range from V<sub>REF</sub> to V<sub>IL</sub>(AC) max for falling edges as shown in the below figure.
3. AC timings are referenced with input waveforms switching from V<sub>IL</sub>(AC) to V<sub>IH</sub>(AC) on the positive transitions and V<sub>IH</sub>(AC) to V<sub>IL</sub>(AC) on the negative transitions.

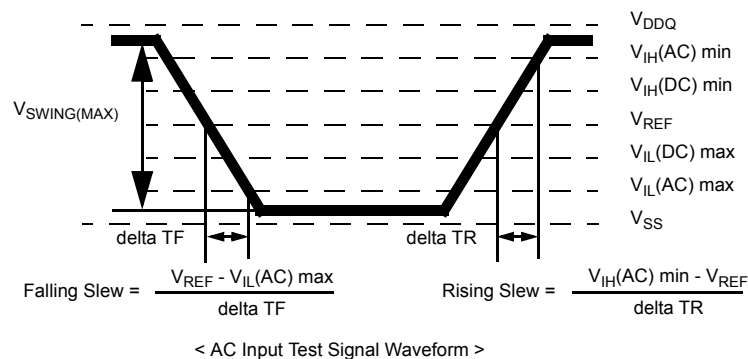

## 10.0 IDD Specification Parameters Definition

(IDD values are for full operating range of Voltage and Temperature)

Symbol	Proposed Conditions	Units	Note
IDD0	<b>Operating one bank active-precharge current;</b> $t_{CK} = t_{CK}(IDD)$ , $t_{RC} = t_{RC}(IDD)$ , $t_{RAS} = t_{RASmin}(IDD)$ ; CKE is HIGH, CS\ is HIGH between valid commands; Address bus inputs are SWITCHING; Data bus inputs are SWITCHING	mA	
IDD1	<b>Operating one bank active-read-precharge current;</b> $I_{OUT} = 0mA$ ; BL = 4, CL = CL(IDD), AL = 0; $t_{CK} = t_{CK}(IDD)$ , $t_{RC} = t_{RC}(IDD)$ , $t_{RAS} = t_{RASmin}(IDD)$ , $t_{RCD} = t_{RCD}(IDD)$ ; CKE is HIGH, CS\ is HIGH between valid commands; Address bus inputs are SWITCHING; Data pattern is same as IDD4W	mA	
IDD2P	<b>Precharge power-down current;</b> All banks idle; $t_{CK} = t_{CK}(IDD)$ ; CKE is LOW; Other control and address bus inputs are STABLE; Data bus inputs are FLOATING	mA	
IDD2Q	<b>Precharge quiet standby current;</b> All banks idle; $t_{CK} = t_{CK}(IDD)$ ; CKE is HIGH, CS\ is HIGH; Other control and address bus inputs are STABLE; Data bus inputs are FLOATING	mA	
IDD2N	<b>Precharge standby current;</b> All banks idle; $t_{CK} = t_{CK}(IDD)$ ; CKE is HIGH, CS\ is HIGH; Other control and address bus inputs are SWITCHING; Data bus inputs are SWITCHING	mA	
IDD3P	<b>Active power-down current;</b> All banks open; $t_{CK} = t_{CK}(IDD)$ ; CKE is LOW; Other control and address bus inputs are STABLE; Data bus inputs are FLOATING	Fast PDN Exit MRS(12) = 0mA	mA
		Slow PDN Exit MRS(12) = 1mA	mA
IDD3N	<b>Active standby current;</b> All banks open; $t_{CK} = t_{CK}(IDD)$ , $t_{RAS} = t_{RASmax}(IDD)$ , $t_{RP} = t_{RP}(IDD)$ ; CKE is HIGH, CS\ is HIGH between valid commands; Other control and address bus inputs are SWITCHING; Data bus inputs are SWITCHING	mA	
IDD4W	<b>Operating burst write current;</b> All banks open, Continuous burst writes; BL = 4, CL = CL(IDD), AL = 0; $t_{CK} = t_{CK}(IDD)$ , $t_{RAS} = t_{RASmax}(IDD)$ , $t_{RP} = t_{RP}(IDD)$ ; CKE is HIGH, CS\ is HIGH between valid commands; Address bus inputs are SWITCHING; Data bus inputs are SWITCHING	mA	
IDD4R	<b>Operating burst read current;</b> All banks open, Continuous burst reads, $I_{OUT} = 0mA$ ; BL = 4, CL = CL(IDD), AL = 0; $t_{CK} = t_{CK}(IDD)$ , $t_{RAS} = t_{RASmax}(IDD)$ , $t_{RP} = t_{RP}(IDD)$ ; CKE is HIGH, CS\ is HIGH between valid commands; Address bus inputs are SWITCHING; Data pattern is same as IDD4W	mA	
IDD5B	<b>Burst auto refresh current;</b> $t_{CK} = t_{CK}(IDD)$ ; Refresh command at every $t_{RFC}(IDD)$ interval; CKE is HIGH, CS\ is HIGH between valid commands; Other control and address bus inputs are SWITCHING; Data bus inputs are SWITCHING	mA	
IDD6	<b>Self refresh current;</b> CK and CK\ at 0V; CKE $\leq 0.2V$ ; Other control and address bus inputs are FLOATING; Data bus inputs are FLOATING	Normal	mA
		Low Power	mA
IDD7	<b>Operating bank interleave read current;</b> All bank interleaving reads, $I_{OUT} = 0mA$ ; BL = 4, CL = CL(IDD), AL = $t_{RCD}(IDD) - 1 * t_{CK}(IDD)$ ; $t_{CK} = t_{CK}(IDD)$ , $t_{RC} = t_{RC}(IDD)$ , $t_{RRD} = t_{RRD}(IDD)$ , $t_{FAW} = t_{FAW}(IDD)$ , $t_{RCD} = 1 * t_{CK}(IDD)$ ; CKE is HIGH, CS\ is HIGH between valid commands; Address bus inputs are STABLE during DESELECTs; Data pattern is same as IDD4R; Refer to the following page for detailed timing conditions	mA	

## 11.0 Operating Current Table :

## 11.1 M470T2864AZ3 : 128Mx64 1GB Module

(TA=0°C, VDD= 1.9V)

Symbol	667@CL=5		533@CL=4		400@CL=3		Unit	Notes
	CE6	LE6	CD5	LD5	CCC	LCC		
IDD0	660		620		580		mA	
IDD1	740		700		660		mA	
IDD2P	120	64	120	64	120	64	mA	
IDD2Q	360		360		320		mA	
IDD2N	360		360		320		mA	
IDD3P-F	320		280		280		mA	
IDD3P-S	144		144		144		mA	
IDD3N	440		440		400		mA	
IDD4W	960		860		740		mA	
IDD4R	980		860		720		mA	
IDD5	1,060		1,040		1,000		mA	
IDD6	120	48	120	48	120	48	mA	
IDD7	1,580		1,540		1,480		mA	

\* Module IDD was calculated on the basis of component IDD and can be differently measured according to DQ loading cap.

## 11.2 M470T6464AZ3: 64Mx64 512MB Module

(TA=0°C, VDD= 1.9V)

Symbol	667@CL=5		533@CL=4		400@CL=3		Unit	Notes
	CE6	LE6	CD5	LD5	CCC	LCC		
IDD0	480		440		420		mA	
IDD1	560		520		500		mA	
IDD2P	60	32	60	32	60	32	mA	
IDD2Q	180		180		160		mA	
IDD2N	180		180		160		mA	
IDD3P-F	160		140		140		mA	
IDD3P-S	72		72		72		mA	
IDD3N	260		260		240		mA	
IDD4W	780		680		580		mA	
IDD4R	800		680		560		mA	
IDD5	880		860		840		mA	
IDD6	60	24	60	24	60	24	mA	
IDD7	1,400		1,360		1,320		mA	

\* Module IDD was calculated on the basis of component IDD and can be differently measured according to DQ loading cap.

## 11.3 M470T5669AZ0: 256Mx64 1GB Module

(TA=0°C, VDD= 1.9V)

Symbol	667@CL=5		533@CL=4		400@CL=3		Unit	Notes
	CE6	LE6	CD5	LD5	CCC	LCC		
IDD0	1,080		1,040		1,000		mA	
IDD1	1,160		1,120		1,080		mA	
IDD2P	240	128	240	128	240	128	mA	
IDD2Q	720		720		640		mA	
IDD2N	720		720		640		mA	
IDD3P-F	640		560		560		mA	
IDD3P-S	288		288		288		mA	
IDD3N	840		840		760		mA	
IDD4W	1,600		1,400		1,240		mA	
IDD4R	1,600		1,400		1,240		mA	
IDD5	2,120		2,080		2,000		mA	
IDD6	240	96	240	96	240	96	mA	
IDD7	2,760		2,600		2,400		mA	

\* Module IDD was calculated on the basis of component IDD and can be differently measured according to DQ loading cap.

## 12.0 Input/Output Capacitance

(V<sub>DD</sub>=1.8V, V<sub>DDQ</sub>=1.8V, T<sub>A</sub>=25°C)

Parameter	Symbol	Min	Max	Min	Max	Min	Max	Units
		M470T2864AZ3		M470T6464AZ3		M470T5669AZ0		
Input capacitance, CK and $\overline{\text{CK}}$	CCK	-	32	-	24	-	48	pF
Input capacitance, CKE, $\overline{\text{CS}}$ , Addr, $\overline{\text{RAS}}$ , $\overline{\text{CAS}}$ , $\overline{\text{WE}}$	CI	-	34	-	34	-	42	
Input/output capacitance, DQ, DM, DQS, $\overline{\text{DQS}}$	CIO(400/533)	-	10	-	6	-	10	
	CIO(667)	-	9	-	5.5	-	9	

\* DM is internally loaded to match DQ and DQS identically.

## 13.0 Electrical Characteristics &amp; AC Timing for DDR2-667/533/400

(0 °C ≤ T<sub>OPER</sub> ≤ 95 °C; V<sub>DDQ</sub> = 1.8V ± 0.1V; V<sub>DD</sub> = 1.8V ± 0.1V)

## 13.1 Refresh Parameters by Device Density

Parameter	Symbol	256Mb	512Mb	1Gb	2Gb	4Gb	Units	
Refresh to active/Refresh command time	tRFC	75	105	127.5	195	327.5	ns	
Average periodic refresh interval	tREFI	0 °C ≤ T <sub>CASE</sub> ≤ 85°C	7.8	7.8	7.8	7.8	7.8	μs
		85 °C < T <sub>CASE</sub> ≤ 95°C	3.9	3.9	3.9	3.9	3.9	μs

## 13.2 Speed Bins and CL, tRCD, tRP, tRC and tRAS for Corresponding Bin

Speed	DDR2-667(E6)		DDR2-533(D5)		DDR2-400(CC)		Units
Bin(CL - tRCD - tRP)	5 - 5 - 5		4 - 4 - 4		3 - 3 - 3		
Parameter	min	max	min	max	min	max	
tCK, CL=3	5	8	5	8	5	8	ns
tCK, CL=4	3.75	8	3.75	8	5	8	ns
tCK, CL=5	3	8	3.75	8	-	-	ns
tRCD	15	-	15	-	15	-	ns
tRP	15	-	15	-	15	-	ns
tRC	54	-	55	-	55	-	ns
tRAS	39	70000	40	70000	40	70000	ns

## 13.3 Timing Parameters by Speed Grade

(Refer to notes for informations related to this table at the bottom)

Parameter	Symbol	DDR2-667		DDR2-533		DDR2-400		Units	Note
		min	max	min	max	min	max		
DQ output access time from $\overline{CK}/\overline{CK}$	tAC	-450	+450	-500	+500	-600	+600	ps	
DQS output access time from $\overline{CK}/\overline{CK}$	tDQSK	-400	+400	-450	+450	-500	+500	ps	
CK high-level width	tCH	0.45	0.55	0.45	0.55	0.45	0.55	tCK	
CK low-level width	tCL	0.45	0.55	0.45	0.55	0.45	0.55	tCK	
CK half period	tHP	min(tCL, tCH)	x	min(tCL, tCH)	x	min(tCL, tCH)	x	ps	
Clock cycle time, CL=x	tCK	3000	8000	3750	8000	5000	8000	ps	
DQ and DM input hold time	tDH(base)	175	x	225	x	275	x	ps	
DQ and DM input setup time	tDS(base)	100	x	100	x	150	x	ps	
Control & Address input pulse width for each input	tIPW	0.6	x	0.6	x	0.6	x	tCK	
DQ and DM input pulse width for each input	tDIPW	0.35	x	0.35	x	0.35	x	tCK	
Data-out high-impedance time from $\overline{CK}/\overline{CK}$	tHZ	x	tAC max	x	tAC max	x	tAC max	ps	
DQS low-impedance time from $\overline{CK}/\overline{CK}$	tLZ(DQS)	tAC min	tAC max	tAC min	tAC max	tAC min	tAC max	ps	
DQ low-impedance time from $\overline{CK}/\overline{CK}$	tLZ(DQ)	2*tACmin	tAC max	2* tACmin	tAC max	2* tACmin	tAC max	ps	
DQS-DQ skew for DQS and associated DQ signals	tDQSQ	x	240	x	300	x	350	ps	
DQ hold skew factor	tQHS	x	340	x	400	x	450	ps	
DQ/DQS output hold time from DQS	tQH	tHP - tQHS	x	tHP - tQHS	x	tHP - tQHS	x	ps	
First DQS latching transition to associated clock edge	tDQSS	-0.25	0.25	-0.25	0.25	-0.25	0.25	tCK	
DQS input high pulse width	tDQSH	0.35	x	0.35	x	0.35	x	tCK	
DQS input low pulse width	tDQSL	0.35	x	0.35	x	0.35	x	tCK	
DQS falling edge to CK setup time	tDSS	0.2	x	0.2	x	0.2	x	tCK	
DQS falling edge hold time from CK	tDSH	0.2	x	0.2	x	0.2	x	tCK	
Mode register set command cycle time	tMRD	2	x	2	x	2	x	tCK	
Write postamble	tWPST	0.4	0.6	0.4	0.6	0.4	0.6	tCK	
Write preamble	tWPRE	0.35	x	0.35	x	0.35	x	tCK	
Address and control input hold time	tIH(base)	275	x	375	x	475	x	ps	
Address and control input setup time	tIS(base)	200	x	250	x	350	x	ps	
Read preamble	tRPRE	0.9	1.1	0.9	1.1	0.9	1.1	tCK	
Read postamble	tRPST	0.4	0.6	0.4	0.6	0.4	0.6	tCK	
Active to active command period for 1KB page size products	tRRD	7.5	x	7.5	x	7.5	x	ns	
Active to active command period for 2KB page size products	tRRD	10	x	10	x	10	x	ns	
Four Activate Window for 1KB page size products	tFAW	37.5		37.5		37.5		ns	
Four Activate Window for 2KB page size products	tFAW	50		50		50		ns	
CAS to CAS command delay	tCCD	2		2		2		tCK	
Write recovery time	tWR	15	x	15	x	15	x	ns	
Auto precharge write recovery + precharge time	tDAL	WR+tRP	x	WR+tRP	x	WR+tRP	x	tCK	
Internal write to read command delay	tWTR	7.5	x	7.5	x	10	x	ns	
Internal read to precharge command delay	tRTP	7.5		7.5		7.5		ns	
Exit self refresh to a non-read command	tXSNR	tRFC + 10		tRFC + 10		tRFC + 10		ns	
Exit self refresh to a read command	tXSRD	200		200		200		tCK	
Exit precharge power down to any non-read command	tXP	2	x	2	x	2	x	tCK	



Parameter	Symbol	DDR2-667		DDR2-533		DDR2-400		Units	Note
		min	max	min	max	min	max		
Exit active power down to read command	tXARD	2	x	2	x	2	x	tCK	
Exit active power down to read command (slow exit, lower power)	tXARDS	7 - AL		6 - AL		6 - AL		tCK	
CKE minimum pulse width (high and low pulse width)	t <sub>CKE</sub>	3		3		3		tCK	
ODT turn-on delay	t <sub>AOND</sub>	2	2	2	2	2	2	tCK	
ODT turn-on	t <sub>AON</sub>	tAC(min)	tAC(max)+0.7	tAC(min)	tAC(max)+1	tAC(min)	tAC(max)+1	ns	
ODT turn-on(Power-Down mode)	t <sub>AONPD</sub>	tAC(min)+2	2tCK+tAC(max)+1	tAC(min)+2	2tCK+tAC(max)+1	tAC(min)+2	2tCK+tAC(max)+1	ns	
ODT turn-off delay	t <sub>AOFD</sub>	2.5	2.5	2.5	2.5	2.5	2.5	tCK	
ODT turn-off	t <sub>AOF</sub>	tAC(min)	tAC(max)+0.6	tAC(min)	tAC(max)+0.6	tAC(min)	tAC(max)+0.6	ns	
ODT turn-off (Power-Down mode)	t <sub>AOFPD</sub>	tAC(min)+2	2.5tCK+tAC(max)+1	tAC(min)+2	2.5tCK+tAC(max)+1	tAC(min)+2	2.5tCK+tAC(max)+1	ns	
ODT to power down entry latency	tANPD	3		3		3		tCK	
ODT power down exit latency	tAXPD	8		8		8		tCK	
OCD drive mode output delay	tOIT	0	12	0	12	0	12	ns	
Minimum time clocks remains ON after CKE asynchronously drops LOW	tDelay	tIS+tCK+tIH		tIS+tCK+tIH		tIS+tCK+tIH		ns	



14.2 64Mbx16 based 64Mx64 Module (1 Rank)

- M470T6464AZ3

Units : Millimeters

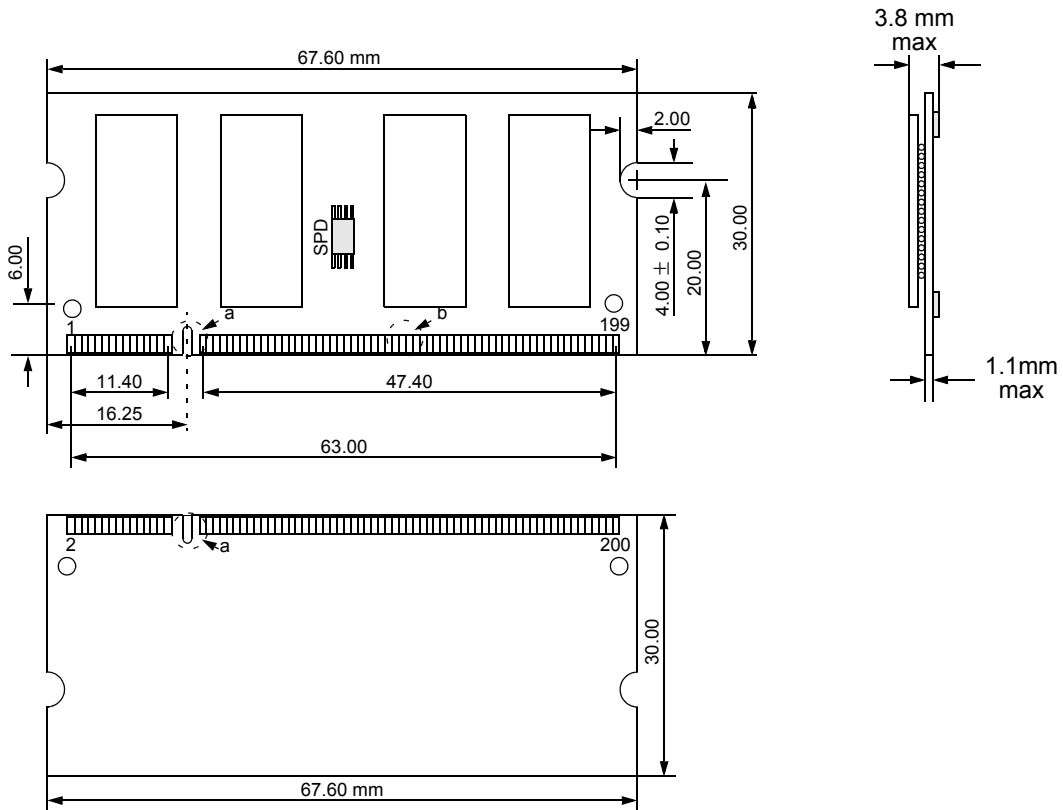

DETAIL a

DETAIL b

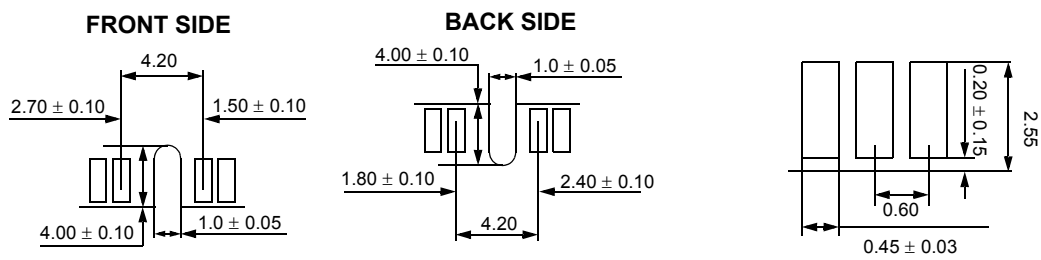

The used device is 64M x16 DDR2 SDRAM, FBGA.  
 DDR2 SDRAM Part NO : K4T1G164QA

14.3 st.256Mbx8 based 256Mx64 Module (2 Ranks)  
 - M470T5669AZ0

Units : Millimeters

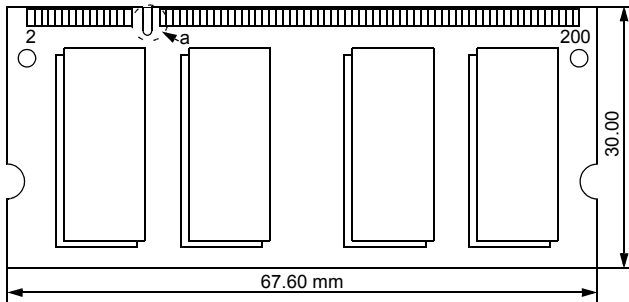
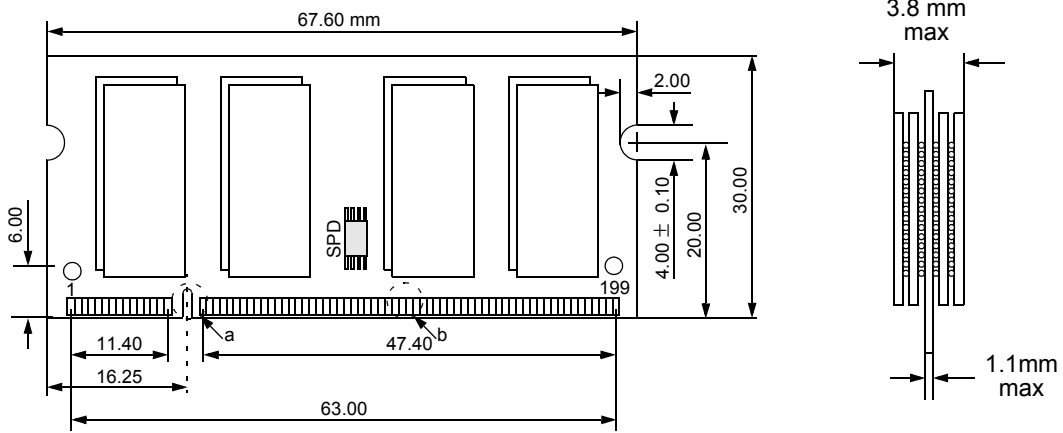

DETAIL a

DETAIL b

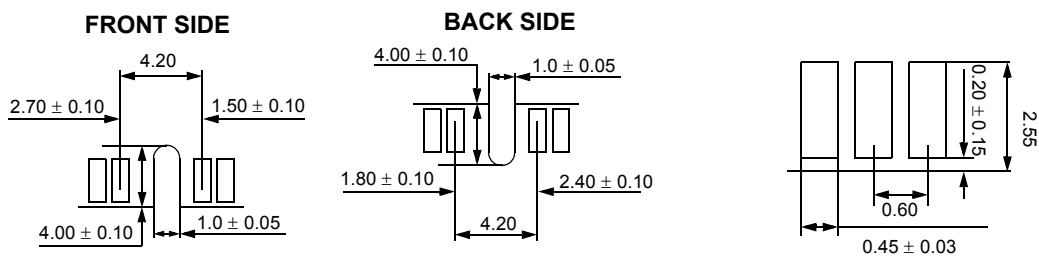

The used device is st.256M x8 DDR2 SDRAM, FBGA.  
 DDR2 SDRAM Part NO : K4T2G074QA



home > products > DRAM > DDR2 SDRAM > SODIMM

## DRAM

DDR3 SDRAM

DDR2 SDRAM

components

registered DIMM

unbuffered DIMM

SODIMM

FBDIMM

EOL products

DDR SDRAM

SDRAM

Mobile SDRAM

XDR™DRAM

RDRAM®

Graphics Memory

UtRAM(PSRAM)

consumer DRAM

## SODIMM

SODIMM > M470T5669AZ0

Technical File Download

PCB & Details

Component & Composition

production & availability

RoHS information

### product search

part no. search

 -   

parametric search

ordering information

### related document

- [DDR2 product guide](#)
- [part number decoder](#)
- [device operation & timing diagram](#)

### related link

- [DRAM application notes](#)
- [label & code information](#)
- [packing information](#)
- [package information](#)
- [memory brochures](#)

### PCB & Details

part number	M470T5669AZ0-CD5	M470T5669AZ0-CE6
Compliance with RoHs	Lead Free	Lead Free
PCB Rev & Type	None	None
PCB Height		
PCB Pins		
PCB Layers	0	0

### Component & Composition

part number	M470T5669AZ0-CD5	M470T5669AZ0-CE6	
Density of Comp.	1G	1G	
Organization of Comp.	x8 Stack(70-mono)	x8 Stack(70-mono)	
Number Of Comp.	K4T1GA84QA-ZCD5000	K4T1GA84QA-ZCE6000	
Part Number of Comp.	8	8	

#### Eco search



- Material data
  - RoHS declaration
  - China RoHS
- [more »](#)

#### production & availability

part number	M470T5669AZ0-CD5	M470T5669AZ0-CE6
life cycle	PRODUCTION	PRODUCTION
die revision	MASS PRODUCTION	MASS PRODUCTION
MOQ (small box)	150	150
MOQ (large box)	450	450
qual sample	Q1/2006	Q1/2006
mass production	Q1/2006	Q1/2006
last time buy	N/A	N/A
last time ship	N/A	N/A
replacement part number		

#### Technical File Download

##### - specification data

file	rev #	size	updated date
 SPD (CE6,CD5,CCC)		21KB	2007/08/13
 Data Sheet	1.4	396KB	2007/08/13
 SPD (LE6,LD5,LCC)		19KB	2007/08/13

##### - simulation models

--	--	--	--

file	rev #	size	updated date
 Electrical Board Description		214KB	2007/08/13

### RoHS information

For more information, please click the button next to the product name.

 material declaration sheet

 does not contain hazardous materials defined in China RoHS

 declaration letter

 contains hazardous materials defined in China RoHS

M470T5669AZ0-CD5 is Lead-free and RoHS-compliant.



M470T5669AZ0-CE6 is Lead-free and RoHS-compliant.



back >