

DO NOT SCALE FROM THIS PRINT

ALL BODIES DIFFERENT AS SHOWN OTHERWISE SAME AS FIGURE 1.

PART NO.	"A"	"B"
XSAX-08	.80 [20.3]	07
XSAX-09	.90 [22.9]	08
XSAX-10	1.00 [25.4]	09
XSAX-11	1.10 [27.9]	10
XSAX-12	1.20 [30.5]	11
XSAX-13	1.30 [33.0]	12
XSAX-14	1.40 [35.6]	13
XSAX-15	1.50 [38.1]	14
XSAX-16	1.60 [40.6]	15
XSAX-17	1.70 [43.2]	16
XSAX-18	1.80 [45.7]	17
XSAX-19	1.90 [48.3]	18
XSAX-20	2.00 [50.8]	19
XSAX-21	2.10 [53.3]	20
XSAX-22	2.20 [55.9]	21
XSAX-23	2.30 [58.4]	22
XSAX-24	2.40 [61.0]	23

PART NO.	COMPONENT
CSAX-08	HPGA-08-64
CSAX-09	HPGA-09-81
CSAX-10	HPGA-10-100
CSAX-11	HPGA-11-121
CSAX-12	HPGA-12-144
CSAX-13	HPGA-13-169
CSAX-14	HPGA-14-196
CSAX-15	HPGA-15-225
CSAX-16	HPGA-16-256
CSAX-17	HPGA-17-289
CSAX-18	HPGA-18-324
CSAX-19	HPGA-19-361
CSAX-20	HPGA-20-400
CSAX-21	HPGA-21-441
CSAX-22	HPGA-22-484
CSAX-23	HPGA-23-529
CSAX-24	HPGA-24-576

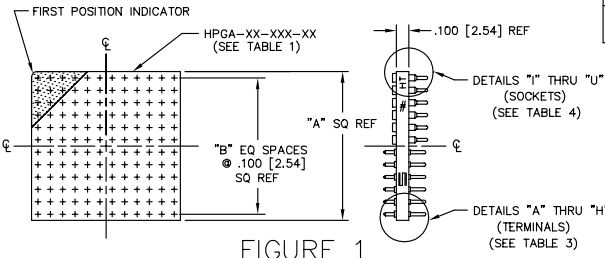

FIGURE 1

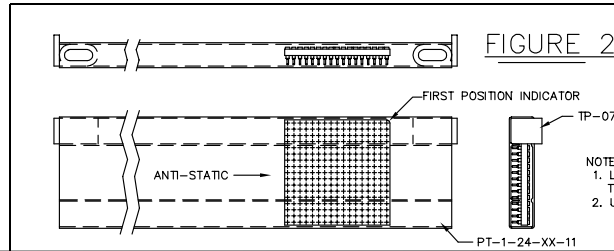

FIGURE 2

- NOTE:
1. LEAD STYLES -ZS AND -ZL TO BE PACKAGED IN TUBES. SEE TABLE 5 FOR TUBE & PLUG USED.
 2. USE 2 PLUGS PER TUBE.

DIMENSIONS ARE IN INCHES		UNLESS OTHERWISE NOTED		TOLERANCES ARE:	TITLE:	DWG NO.:
ONE PLACE DECIMALS ± .1	[3]	THREE PLACE DECIMALS ± .005	[.13]	ANGLES ± 1°	HPGA ASSEMBLY WITH SOCKETS OR TERMINALS	XSAX-XXX-XX-X(X)-XXXX-XX
TWO PLACE DECIMALS ± .01	[.3]	FOUR PLACE DECIMALS ± .0020	[.05]			SHEET 1 OF 2

XSAX-XXX-XX-X(X)-XXXX-X

BODY STYLE:
 M: VENTILATED (SEE TABLE 5)
 ON SHEET 2 FOR AVAILABLE STYLES
 C: CUSTOM (SEE TABLE 2)

CONTACT TYPE:
 S: SOCKET
 T: TERMINAL

LEAD QUANTITY SPECIFICATION (SEE TABLE 3 FOR TERMINALS) (SEE TABLE 4 FOR SOCKETS)

LEAD SPECIFICATION (SEE TABLE 3 FOR TERMINALS) (SEE TABLE 4 FOR SOCKETS)

OPTION:
 -2: .360 [9.14] WIRE WRAP (-ZW ONLY)
 -3: .260 [6.60] WIRE WRAP (-ZW ONLY)
 -L: LOCKING SOCKET (-ZS ONLY) (USE SC-1L1-XX IN 4 CORNERS OF GRID)

GRID SIZE SPECIFICATION: XX x XX (08 x 08 THRU 24 x 24 AVAILABLE)

PLATING SPECIFICATION: (SEE TABLE 3)

SOCKETS:
 -GG: GOLD CONTACT, GOLD SHELL (SPECIFY -GG IN SOCKET SUFFIX -XX)
 -GT: GOLD CONTACT, TIN SHELL (SPECIFY -GT IN SOCKET SUFFIX -XX)
 -TT: TIN CONTACT, TIN SHELL (SPECIFY -TT IN SOCKET SUFFIX -XX)
 -ST: LOW GOLD CONTACT, TIN SHELL (SPECIFY -ST IN SOCKET SUFFIX -XX) (ON -L OPTION USE SC-1L1-GT)

TERMINALS:
 -G: GOLD TERMINAL (SPECIFY -G IN TERMINAL SUFFIX -X)
 -T: TIN TERMINAL (SPECIFY -T IN TERMINAL SUFFIX -X)

OTHER SPECIFICATIONS:
 -EE: EXTRA HEAVY GOLD CONTACT/EXTRA HEAVY GOLD SHELL (STYLE -ZS ONLY) (SPECIFY -EE IN SOCKET SUFFIX -XX)
 -EG: EXTRA HEAVY GOLD CONTACT/GOLD SHELL (STYLE -ZS ONLY) (SPECIFY -EG IN SOCKET SUFFIX -XX)
 -ET: EXTRA HEAVY GOLD CONTACT/TIN SHELL (STYLE -ZS ONLY) (SPECIFY -ET IN SOCKET SUFFIX -XX)
 -GE: GOLD CONTACT/EXTRA HEAVY GOLD SHELL (STYLE -ZS ONLY) (SPECIFY -GE IN SOCKET SUFFIX -XX)
 -TE: TIN CONTACT/EXTRA HEAVY GOLD SHELL (STYLE -ZS ONLY) (SPECIFY -TE IN SOCKET SUFFIX -XX)

LEAD STYLE	GRID	TUBE	PLUG
-ZS	11 THRU 17	PT-1-24-01-11	TP-07
-ZS	18 THRU 20	PT-1-24-02-11	TP-07
-ZL	13	PT-1-24-05-13	TP-25
-ZL	15	PT-1-24-05-28	TP-07

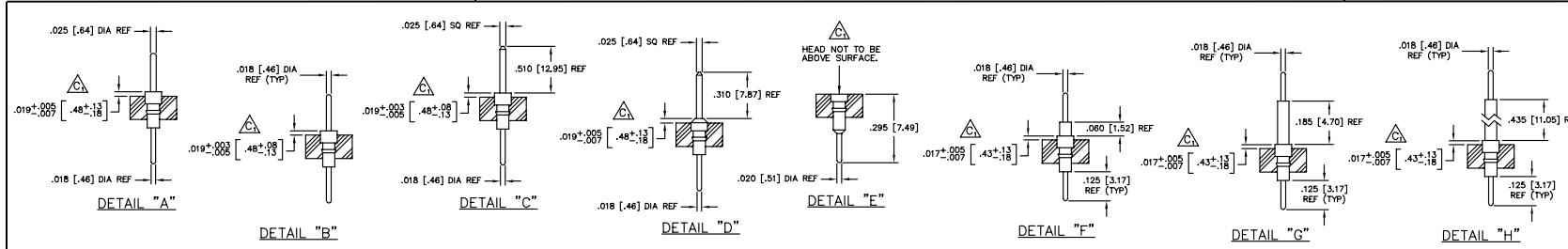

LEAD STYLE	TERMINAL	DETAIL
-A	T-1R0-X	"A"
-A1	T-1R5-X	"B"
-D	T-1S4-1-1-X	"C"
-D1	T-1S4-1-2-X	"D"
-J	S-1P1-X	"E"
-M	T-1R14-1-X	"F"
-N	T-1R14-2-X	"G"
-P	T-1R14-3-G	"H"
-P	T-1R14-3-T	"H"

* = NOT APPROVED BY ENGINEERING
 USE FOR QUOTING, PRELIMINARY DESIGN, PROTOTYPING AND INFORMATIONAL PURPOSES ONLY

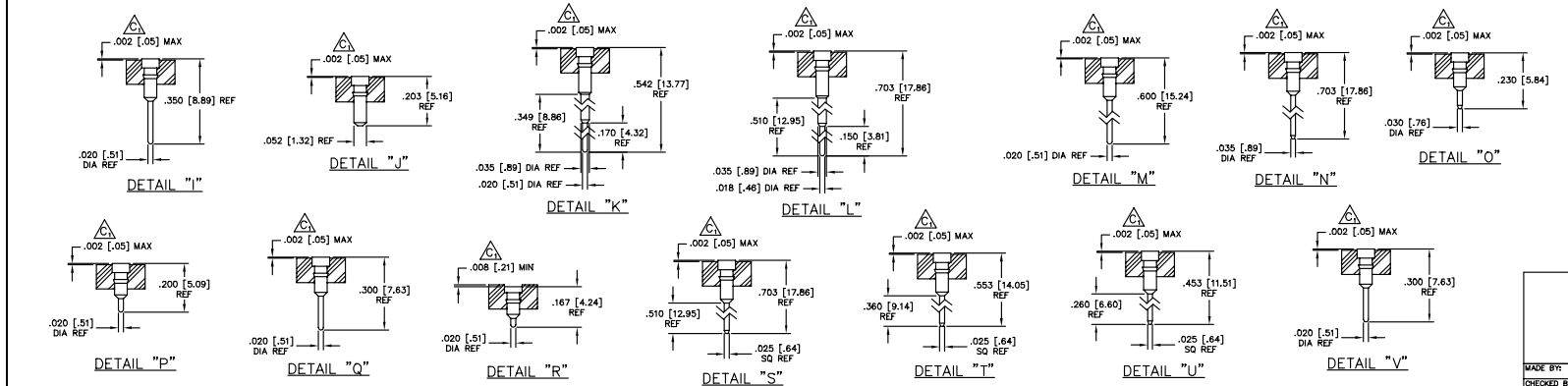

LEAD STYLE	SOCKET	DETAIL
-ZA	EZ-6P1-XX	"I"
-ZB	EZ-1S1-XX	"J"
-ZC	EZ-2P3-XX	"K"
-ZH	EZ-2P2-XX	"L"
-J	SC-1P3-XX	"M"
-K	SC-2P1-XX	"N"
-ZL	EZ-3P1-XX	"O"
-ZP	EZ-1M1-XX	"P"
-ZS	EZ-1P1-XX	"Q"
-ZT	EZ-1M2-XX	"R"
-ZW	EZ-1W1-XX-1	"S"
-ZW-2	EZ-1W1-XX-2	"T"
-ZW-3	EZ-1W1-XX-3	"U"
-ZU	UZ-1P1-XX-HH	"V"

PROPRIETARY NOTE
 THIS DOCUMENT CONTAINS INFORMATION OF A CONFIDENTIAL AND PROPRIETARY NATURE. IT IS THE PROPERTY OF SAMTEC AND IS TO BE USED ONLY FOR THE PURPOSES SPECIFIED. IT IS NOT TO BE REPRODUCED, COPIED, OR TRANSMITTED IN ANY FORM OR BY ANY MEANS, ELECTRONIC OR MECHANICAL, INCLUDING PHOTOCOPYING, RECORDING, OR BY ANY INFORMATION STORAGE AND RETRIEVAL SYSTEM, WITHOUT THE WRITTEN CONSENT OF SAMTEC INC.

REV. M

DO NOT SCALE FROM THIS PRINT ALL BODIES DIFFERENT AS SHOWN. OTHERWISE SAME AS FIG. 1

DIMENSIONS ARE IN INCHES UNLESS OTHERWISE NOTED		TOLERANCES ARE:	TITLE:	DWG NO.:
ONE PLACE DECIMALS ± .1 [3]	THREE PLACE DECIMALS ± .005 [13]	ANGLES ± 1°	HPGA ASSEMBLY WITH SOCKETS OR TERMINALS	XSAX-XX-XX-X(X)-XXXX-XX
TWO PLACE DECIMALS ± .01 [3]	FOUR PLACE DECIMALS ± .0020 [101]			SHEET 2 OF 2

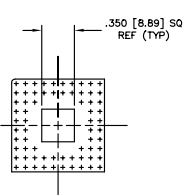

MSAX-068-XX-XX-10

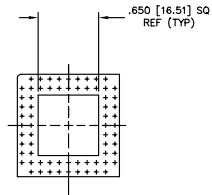

MSAX-068-XX-XX-11

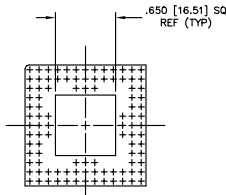

MSAX-101-XX-XX-13

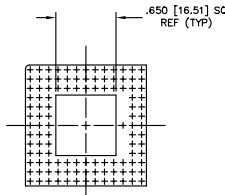

MSAX-114-XX-XX-13

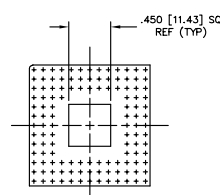

MSAX-121-XX-XX-13A

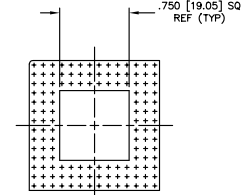

MSAX-132-XX-XX-14

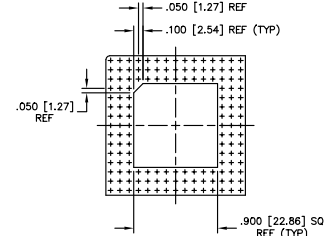

MSAX-144-XX-XX-15

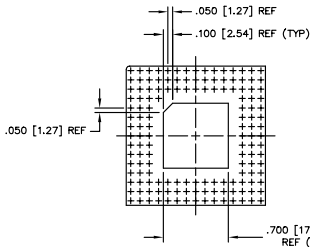

MSAX-145-XX-XX-15

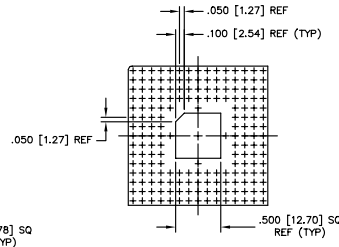

MSAX-181-XX-XX-15

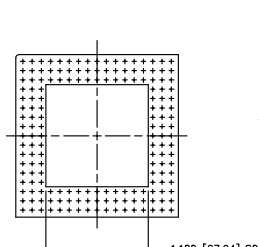

MSAX-168-XX-XX-17

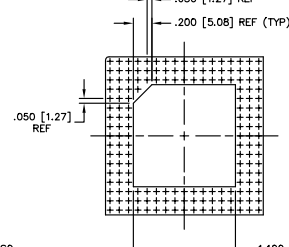

MSAX-169-XX-XX-17

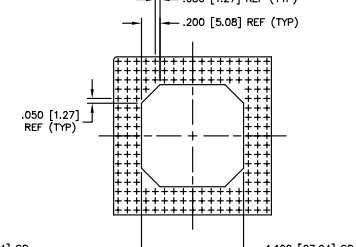

MSAX-169-XX-XX-17A

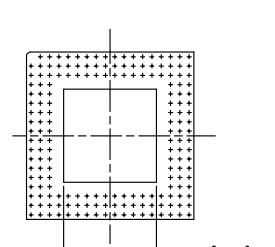

MSAX-179-XX-XX-18

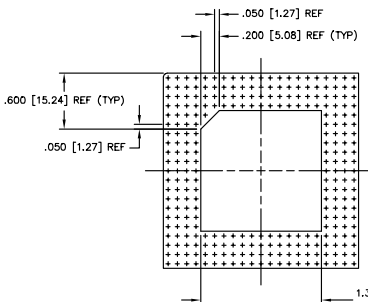

MSAX-273-XX-XX-21

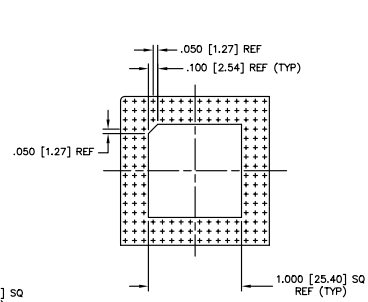

MSAX-156-XX-XX-16

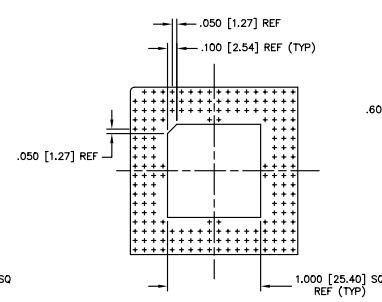

MSAX-191-XX-XX-18

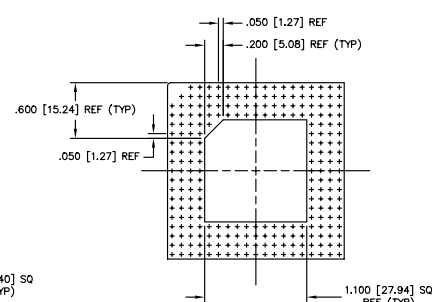

MSAX-238-XX-XX-19

PART NO.	COMPONENT
MSAX-068-XX-XX-10	HPGA-10-68-O
MSAX-068-XX-XX-11	HPGA-11-68-O
MSAX-101-XX-XX-13	HPGA-13-101-O
MSAX-114-XX-XX-13	HPGA-13-114-O
MSAX-121-XX-XX-13A	HPGA-13-121-OA
MSAX-132-XX-XX-14	HPGA-14-132-O
MSAX-144-XX-XX-15	HPGA-15-144-O
MSAX-145-XX-XX-15	HPGA-15-145-O
MSAX-181-XX-XX-15	HPGA-15-181-O
MSAX-156-XX-XX-16	HPGA-16-156-O
MSAX-168-XX-XX-17	HPGA-17-168-O
MSAX-169-XX-XX-17	HPGA-17-169-O
MSAX-169-XX-XX-17A	HPGA-17-169-OA
MSAX-179-XX-XX-18	HPGA-18-179-O
MSAX-191-XX-XX-18	HPGA-18-191-O
MSAX-238-XX-XX-19	HPGA-19-238-O
MSAX-273-XX-XX-21	HPGA-21-273-O

PROPRIETARY NOTE
THIS DOCUMENT CONTAINS PROPRIETARY INFORMATION AND IS THE PROPERTY OF SAMTEC INC. AND SHALL NOT BE REPRODUCED OR TRANSMITTED IN ANY FORM OR BY ANY MEANS, ELECTRONIC OR MECHANICAL, INCLUDING PHOTOCOPYING, RECORDING, OR BY ANY INFORMATION STORAGE AND RETRIEVAL SYSTEM, WITHOUT THE WRITTEN CONSENT OF SAMTEC INC.

MSC/MKTG,
XSAXMKT2

samtec

520 PARK EAST BLVD., NEW ALBANY, INDIANA 47150
PHONE (812) 344-6733 P.O. BOX 1147
CODE 55322

MADE BY: BRYANT 5-20-91 APPROV: XSAX-XX-XX-X(X)-XXXX-X
CHECKED BY: SHEET 2 OF 2