



Features

- 9A Peak Source/Sink Drive Current
- Wide Operating Voltage Range: 4.5V to 35V
- -40°C to +125°C Extended Operating Temperature Range
- Logic Input Withstands Negative Swing of up to 5V
- Matched Rise and Fall Times
- Low Propagation Delay Time
- Low, 10µA Supply Current
- Low Output Impedance

Applications

- Efficient Power MOSFET and IGBT Switching
- Switch Mode Power Supplies
- Motor Controls
- DC to DC Converters
- Class-D Switching Amplifiers
- Pulse Transformer Driver



Description

The IXDD609/IXDI609/IXDN609 high-speed gate drivers are especially well suited for driving the latest IXYS MOSFETs and IGBTs. The IXD_609 high-current output can source and sink 9A of peak current while producing voltage rise and fall times of less than 25ns. The input is CMOS compatible, and is virtually immune to latch up. Proprietary circuitry eliminates cross-conduction and current “shoot-through.” Low propagation delay and fast, matched rise and fall times make the IXD_609 family ideal for high-frequency and high-power applications.

The IXDD609 is configured as a non-inverting driver with an enable, the IXDN609 is configured as a non-inverting driver, and the IXDI609 is configured as an inverting driver.

The IXD_609 family is available in a standard 8-pin DIP (PI); 8-lead SOIC (SIA); 8-lead SOIC with an exposed, grounded metal back (SI); an 8-lead DFN (D2) package; and a 5-pin TO-263 package.

Ordering Information

Part Number	Logic Configuration	Package Type	Packing Method	Quantity
IXDD609D2TR		8-Lead DFN	Tape & Reel	2000
IXDD609SI		8-Lead SOIC with Exposed Grounded Metal Back	Tube	100
IXDD609SITR		8-Lead SOIC with Exposed Grounded Metal Back	Tape & Reel	2000
IXDD609SIA		8-Lead SOIC	Tube	100
IXDD609SIATR		8-Lead SOIC	Tape & Reel	2000
IXDD609PI		8-Pin DIP	Tube	50
IXDD609YI		5-Pin TO-263	Tube	50
IXDI609SI		8-Lead SOIC with Exposed Grounded Metal Back	Tube	100
IXDI609SITR		8-Lead SOIC with Exposed Grounded Metal Back	Tape & Reel	2000
IXDI609SIA		8-Lead SOIC	Tube	100
IXDI609SIATR		8-Lead SOIC	Tape & Reel	2000
IXDI609PI		8-Pin DIP	Tube	50
IXDI609YI		5-Pin TO-263	Tube	50
IXDN609SI		8-Lead SOIC with Exposed Grounded Metal Back	Tube	100
IXDN609SITR		8-Lead SOIC with Exposed Grounded Metal Back	Tape & Reel	2000
IXDN609SIA		8-Lead SOIC	Tube	100
IXDN609SIATR		8-Lead SOIC	Tape & Reel	2000
IXDN609PI		8-Pin DIP	Tube	50
IXDN609YI		5-Pin TO-263	Tube	50

1. Specifications	3
1.1 Pin Configurations	3
1.2 Pin Definitions	3
1.3 Absolute Maximum Ratings	3
1.4 Recommended Operating Conditions	4
1.5 Electrical Characteristics	4
1.6 Electrical Characteristics	5
1.7 Thermal Characteristics	5
2. Functional Description	6
2.1 IXDD609 Functional Block Diagram	6
2.2 IXDI609 Functional Block Diagram	6
2.3 IXDN609 Functional Block Diagram	6
2.4 Timing Diagrams	7
2.5 Characteristics Test Diagram	7
3. Performance Data	8
4. Manufacturing Information	11
4.1 Mechanical Dimensions	11

1 Specifications

1.1 Pin Configurations

IXDD609 D2 / PI / SI / SIA

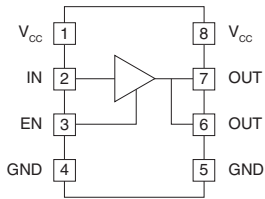

IXDD609 Y1

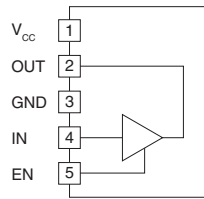

IXDI609 PI / SI / SIA

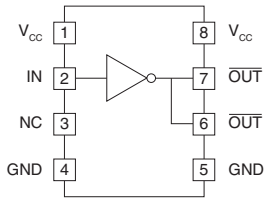

IXDI609 Y1

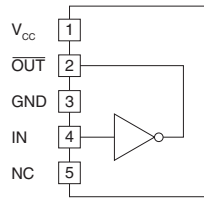

IXDN609 PI / SI / SIA

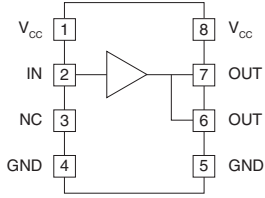

IXDN609 Y1

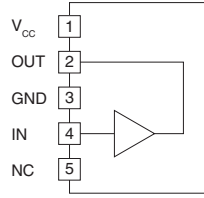

1.2 Pin Definitions

Pin Name	Description
IN	Logic Input
EN	Output Enable - Drive pin low to disable output, and force output to a high impedance state
OUT	Output - Sources or sinks current to turn-on or turn-off a discrete MOSFET or IGBT
$\overline{\text{OUT}}$	Inverted Output - Sources or sinks current to turn-on or turn-off a discrete MOSFET or IGBT
V_{CC}	Supply Voltage - Provides power to the device
GND	Ground - Common ground reference for the device
NC	Not connected

1.3 Absolute Maximum Ratings

Parameter	Symbol	Minimum	Maximum	Units
Supply Voltage	V_{CC}	-	40	V
All Other Pins	-	-0.3	$V_{CC}+0.3$	V
Output Current	I_{OUT}	-	± 9	A
Junction Temperature	T_J	-55	+150	$^{\circ}\text{C}$
Storage Temperature	T_{STG}	-65	+150	$^{\circ}\text{C}$

Unless stated otherwise, absolute maximum electrical ratings are at 25°C

Absolute maximum ratings are stress ratings. Stresses in excess of these ratings can cause permanent damage to the device. Functional operation of the device at conditions beyond those indicated in the operational sections of this data sheet is not implied.

1.4 Recommended Operating Conditions

Parameter	Symbol	Minimum	Maximum	Units
Supply Voltage	V_{CC}	4.5	35	V
Operating Temperature Range	T_A	-40	+125	°C

1.5 Electrical Characteristics

Test Conditions: $T_A=25^{\circ}\text{C}$, $4.5\text{V} \leq V_{CC} \leq 35\text{V}$.

Parameter	Conditions	Symbol	Minimum	Typical	Maximum	Units
Input Voltage, High	$4.5\text{V} \leq V_{CC} \leq 18\text{V}$	V_{IH}	3.0	-	-	V
Input Voltage, Low	$4.5\text{V} \leq V_{CC} \leq 18\text{V}$	V_{IL}	-	-	0.8	
Input Voltage Range	-	V_{IN}	-5	-	$V_{CC}+0.3$	
Input Current	$0\text{V} \leq V_{IN} \leq V_{CC}$	I_{IN}	-10	-	10	μA
EN Input Voltage, High	IXDD609 only	V_{ENH}	$2/3V_{CC}$	-	-	V
EN Input Voltage, Low	IXDD609 only	V_{ENL}	-	-	$1/3V_{CC}$	
Output Voltage, High	-	V_{OH}	$V_{CC}-0.025$	-	-	V
Output Voltage, Low	-	V_{OL}	-	-	0.025	
Output Resistance, High State	$V_{CC}=18\text{V}$, $I_{OUT}=-10\text{mA}$	R_{OH}	-	0.6	1	Ω
Output Resistance, Low State	$V_{CC}=18\text{V}$, $I_{OUT}=10\text{mA}$	R_{OL}	-	0.4	0.8	
Output Current, Continuous	Limited by package power dissipation	I_{DC}	-	-	± 2	A
Rise Time	$C_{LOAD}=10\text{nF}$, $V_{CC}=18\text{V}$	t_R	-	22	45	ns
Fall Time	$C_{LOAD}=10\text{nF}$, $V_{CC}=18\text{V}$	t_F	-	15	40	
On-Time Propagation Delay	$C_{LOAD}=10\text{nF}$, $V_{CC}=18\text{V}$	t_{ONDLY}	-	37	50	
Off-Time Propagation Delay	$C_{LOAD}=10\text{nF}$, $V_{CC}=18\text{V}$	t_{OFFDLY}	-	38	50	
Enable to Output-High Delay Time	IXDD609 only	t_{ENOH}	-	35	50	
Disable to High Impedance State Delay Time	IXDD609 only	t_{DOLD}	-	70	80	
Enable Pull-Up Resistor	-	R_{EN}	-	200	-	
Power Supply Current	$V_{CC}=18\text{V}$, $V_{IN}=3.5\text{V}$	I_{CC}	-	1	3	mA
	$V_{CC}=18\text{V}$, $V_{IN}=0\text{V}$		-	-	10	
	$V_{CC}=18\text{V}$, $V_{IN}=V_{CC}$		-	-	10	μA

1.6 Electrical Characteristics

Test Conditions: $T_A = -40^{\circ}\text{C}$ to $+125^{\circ}\text{C}$, $4.5\text{V} \leq V_{CC} \leq 35\text{V}$, $T_J < 150^{\circ}\text{C}$.

Parameter	Conditions	Symbol	Minimum	Typical	Maximum	Units
Input Voltage, High	$4.5\text{V} \leq V_{CC} \leq 18\text{V}$	V_{IH}	3.0	-	-	V
Input Voltage, Low	$4.5\text{V} \leq V_{CC} \leq 18\text{V}$	V_{IL}	-	-	0.8	
Input Voltage Range	-	V_{IN}	-5	-	$V_{CC} + 0.3$	
Input Current	$0\text{V} \leq V_{IN} \leq V_{CC}$	I_{IN}	-10	-	10	μA
Output Voltage, High	-	V_{OH}	$V_{CC} - 0.025$	-	-	V
Output Voltage, Low	-	V_{OL}	-	-	0.025	
Output Resistance, High State	$V_{CC} = 18\text{V}$, $I_{OUT} = -10\text{mA}$	R_{OH}	-	-	2	Ω
Output Resistance, Low State	$V_{CC} = 18\text{V}$, $I_{OUT} = 10\text{mA}$	R_{OL}	-	-	1.5	
Output Current, Continuous	Limited by package power dissipation	I_{DC}	-	-	± 1	A
Rise Time	$C_{LOAD} = 10\text{nF}$, $V_{CC} = 18\text{V}$	t_R	-	-	60	ns
Fall Time	$C_{LOAD} = 10\text{nF}$, $V_{CC} = 18\text{V}$	t_F	-	-	60	
On-Time Propagation Delay	$C_{LOAD} = 10\text{nF}$, $V_{CC} = 18\text{V}$	t_{ONDLY}	-	-	55	
Off-Time Propagation Delay	$C_{LOAD} = 10\text{nF}$, $V_{CC} = 18\text{V}$	t_{OFFDLY}	-	-	40	
Enable to Output-High Delay Time	IXDD609 only	t_{ENOH}	-	-	60	
Disable to High Impedance State Delay Time	IXDD609 only	t_{DOLD}	-	-	100	
Power Supply Current	$V_{CC} = 18\text{V}$, $V_{IN} = 3.5\text{V}$	I_{CC}	-	1	3	mA
	$V_{CC} = 18\text{V}$, $V_{IN} = 0\text{V}$		-	-	10	μA
	$V_{CC} = 18\text{V}$, $V_{IN} = V_{CC}$		-	-	10	

1.7 Thermal Characteristics

Package	Parameter	Rating	Units
D2 (8-Lead DFN)	θ_{JA}	35	$^{\circ}\text{C/W}$
PI (8-Lead DIP)		125	
SI (8-Lead SOIC with Exposed Metal Back)		85	
SIA (8-Lead SOIC)		120	
YI (5-Lead TO-263)		46	

2 Functional Description

2.1 IXDD609 Functional Block Diagram

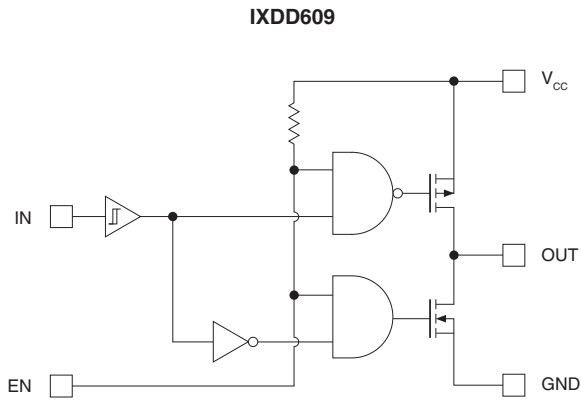

IN	EN	OUT
0	1 or open	0
1	1 or open	1
0	0	Z
1	0	Z

2.3 IXDN609 Functional Block Diagram

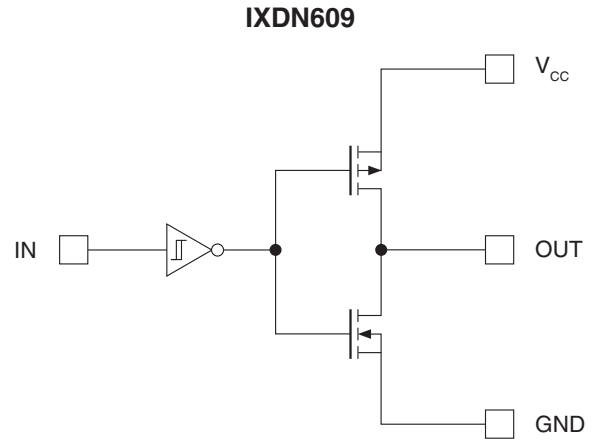

IN	OUT
0	0
1	1

2.2 IXDI609 Functional Block Diagram

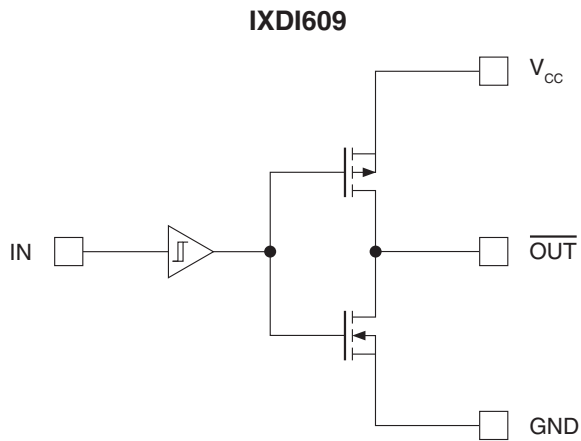

IN	$\overline{\text{OUT}}$
0	1
1	0

2.4 Timing Diagrams

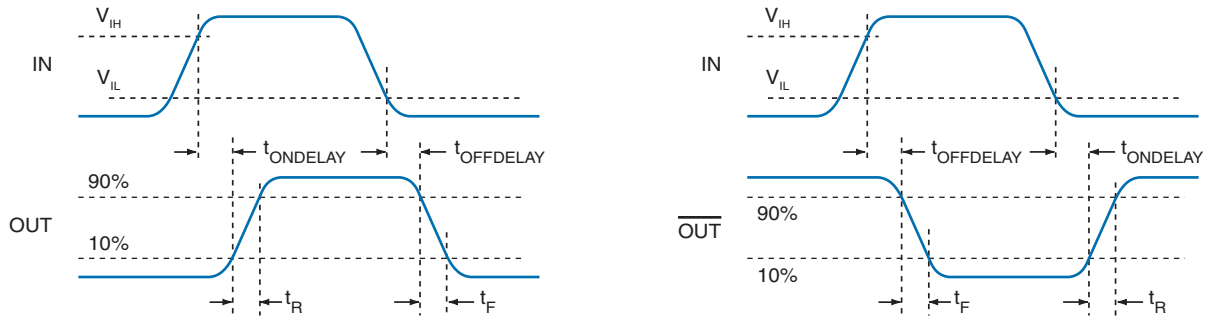

2.5 Characteristics Test Diagram

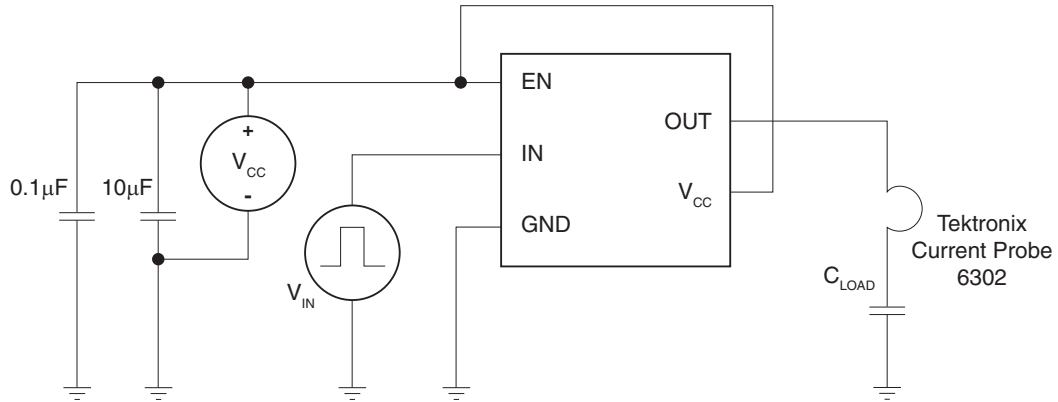

3 Performance Data

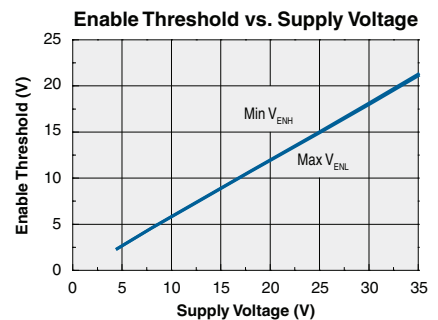
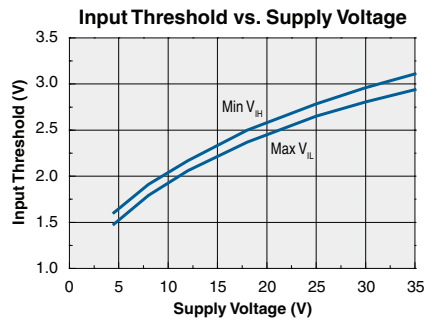
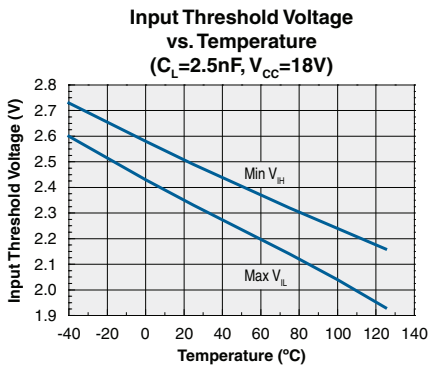
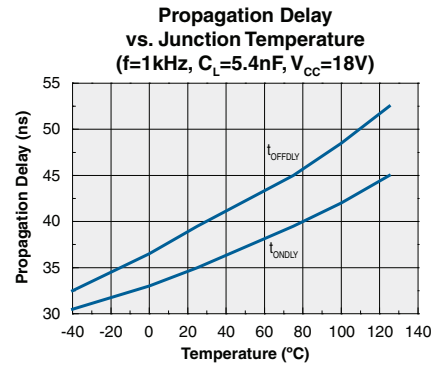
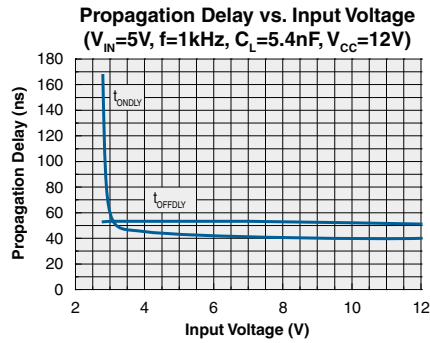
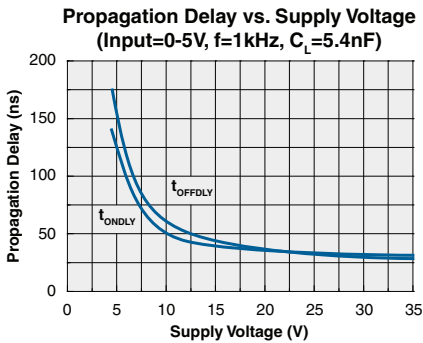
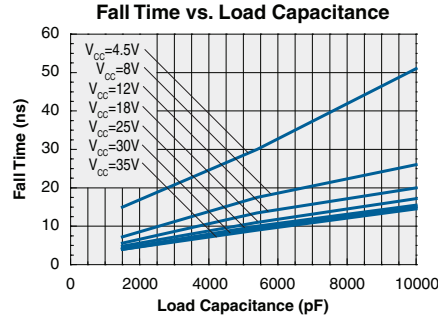
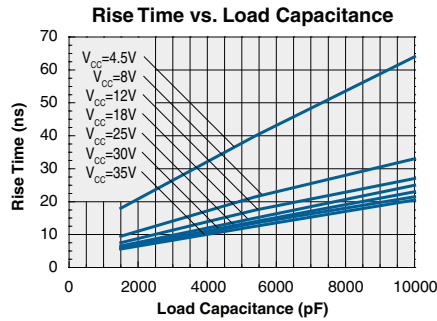
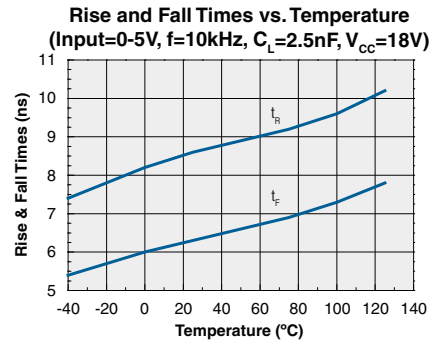
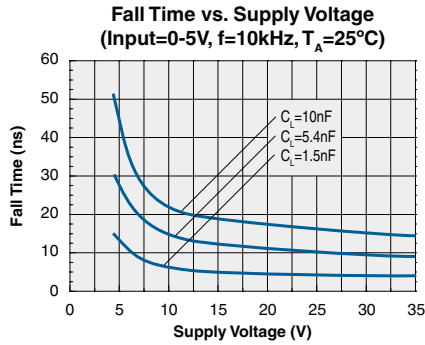
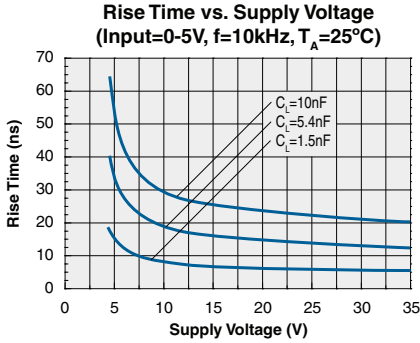

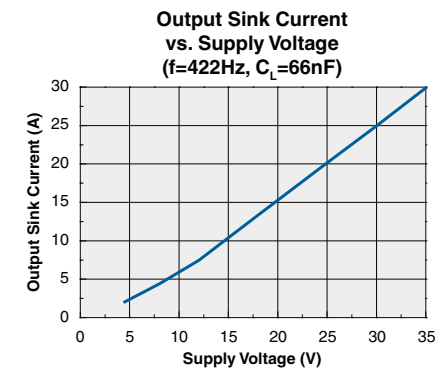
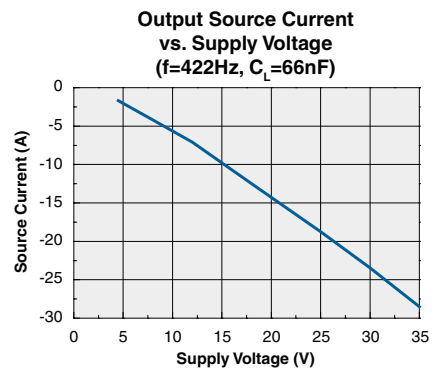
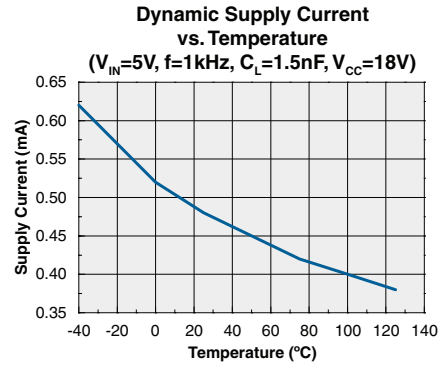
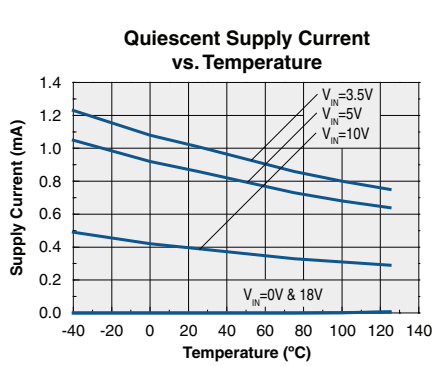
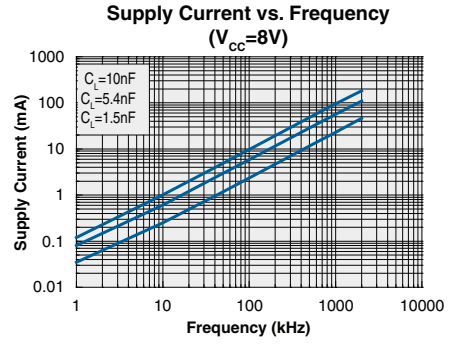
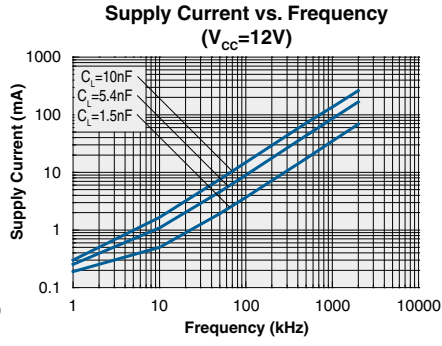
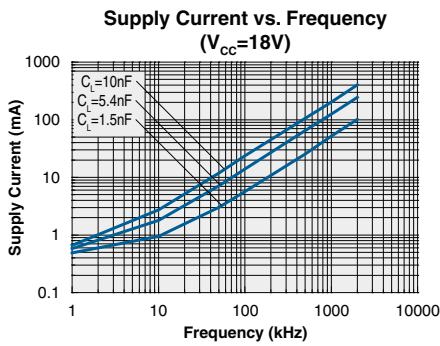
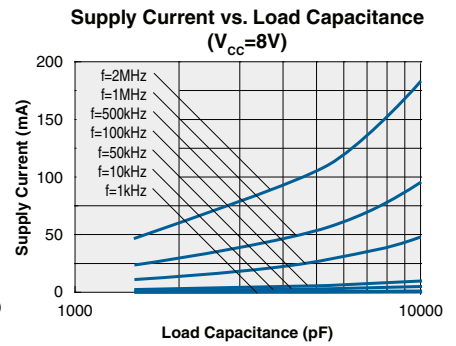
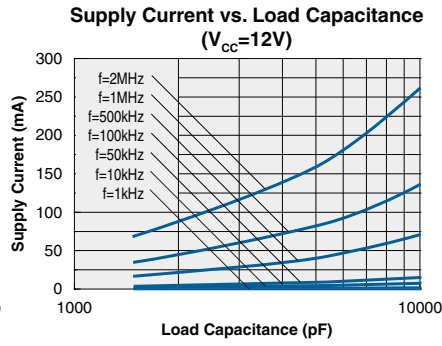
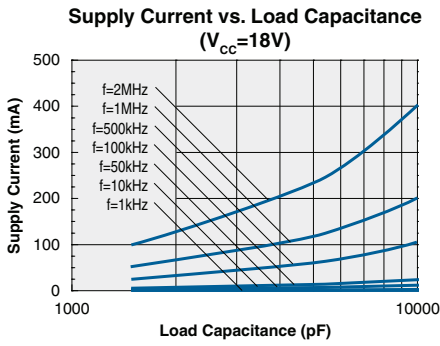

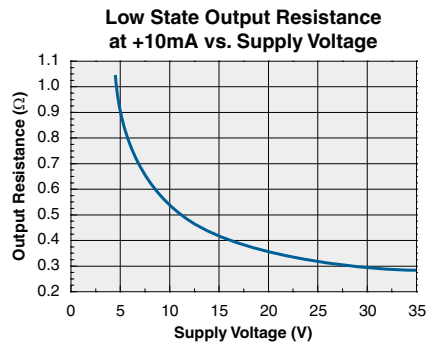
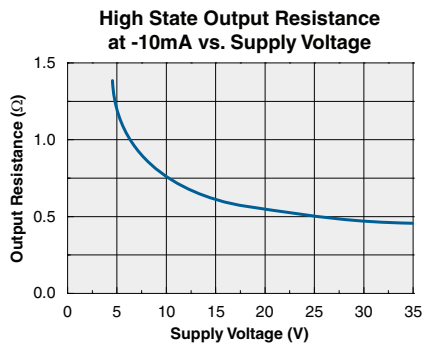
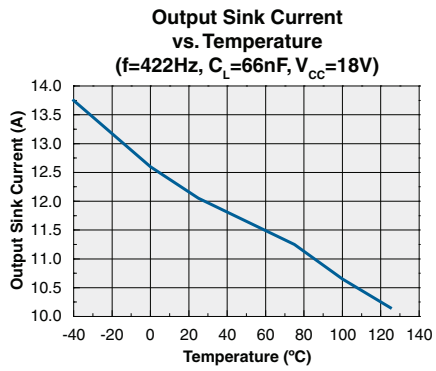
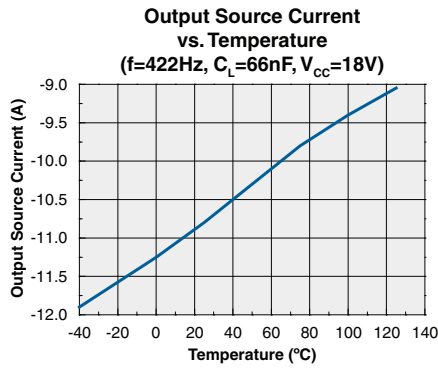

4 Manufacturing Information

4.1 Mechanical Dimensions

4.1.1 8-Pin SOIC - IXD_609SIA

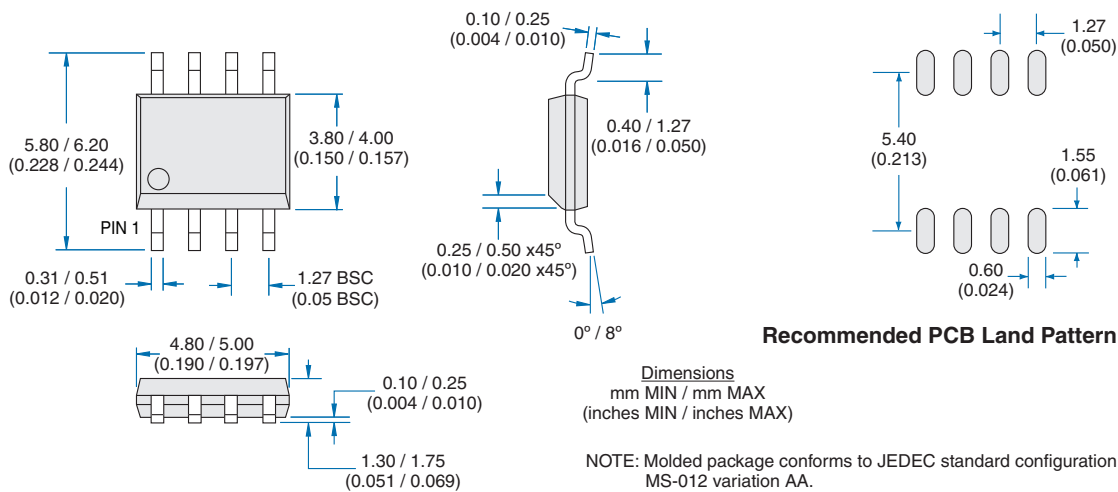

4.1.2 8-Pin SOIC - IXD_609SI

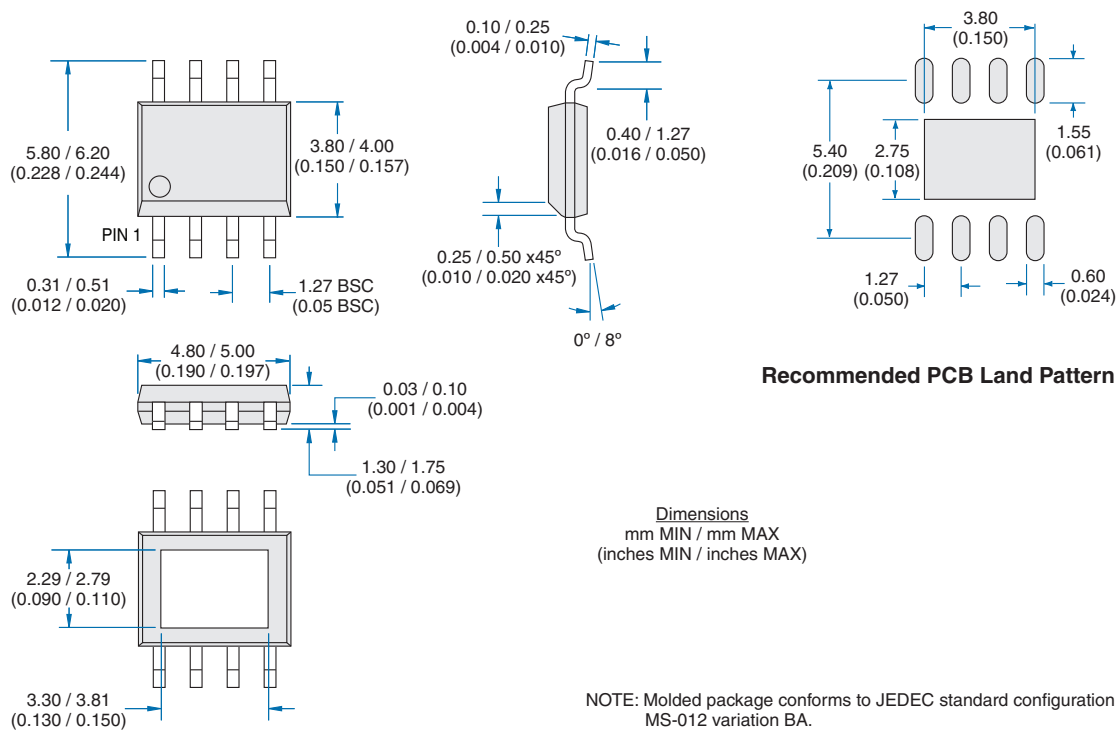

4.1.3 8-Pin DFN - IXD_609D2

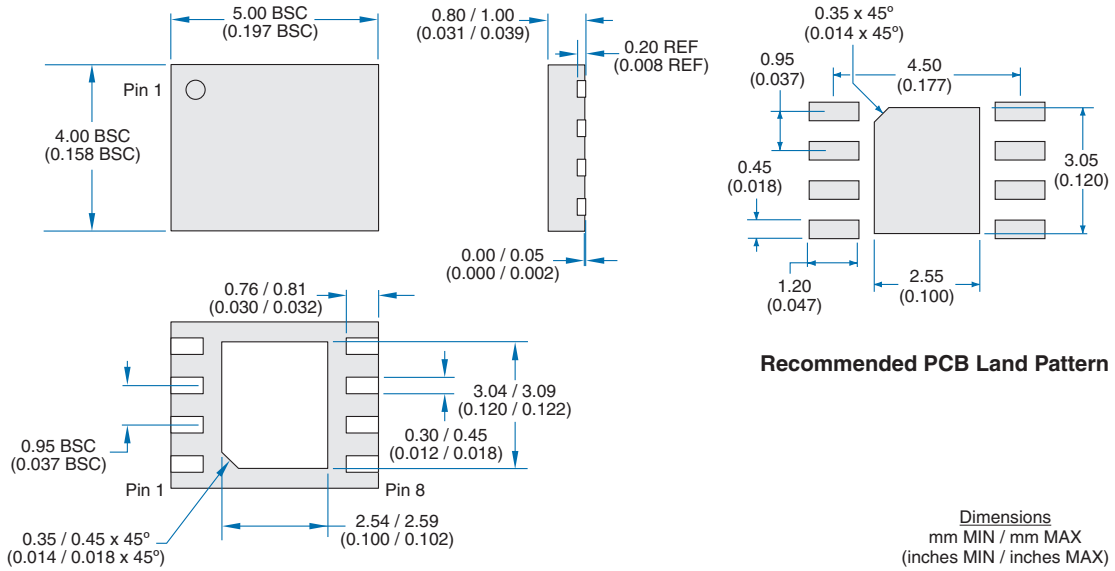

4.1.4 8-Pin DIP - IXD_609PI

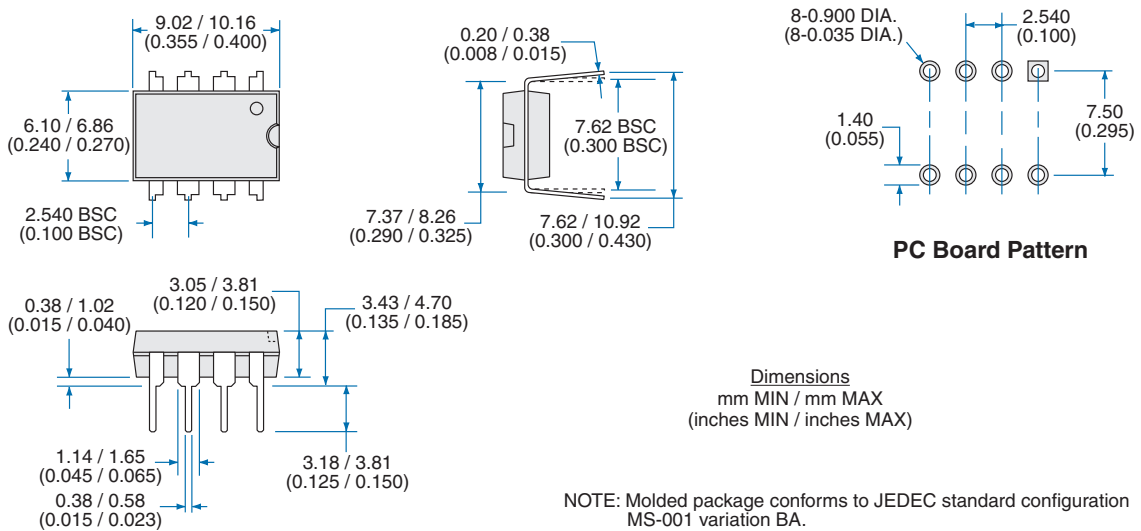

4.1.5 5-Pin TO-263 - IXD_609Y1

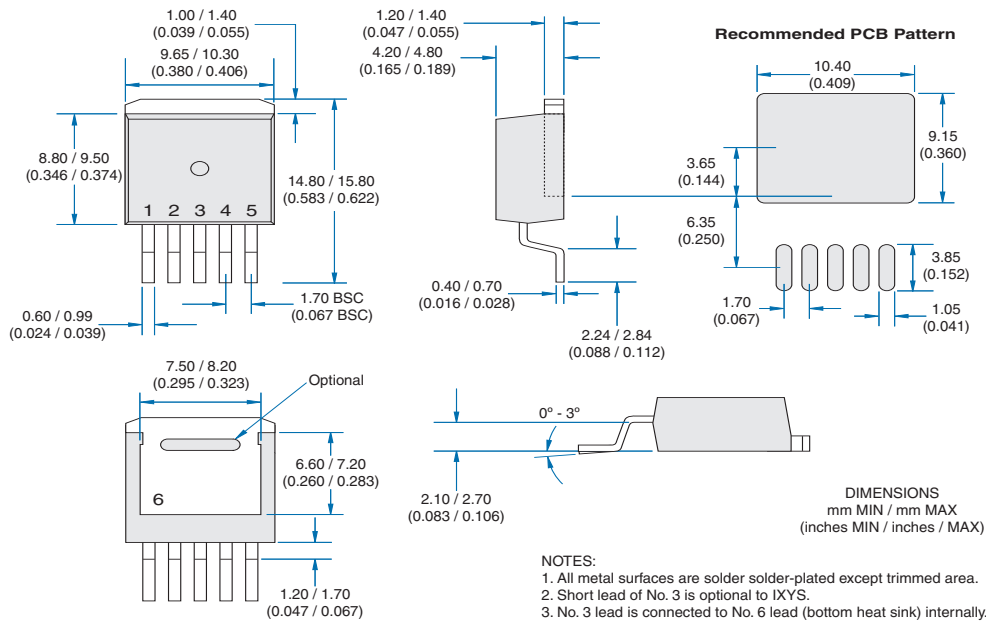

For additional information please visit our website at: www.clare.com

Clare, Inc. makes no representations or warranties with respect to the accuracy or completeness of the contents of this publication and reserves the right to make changes to specifications and product descriptions at any time without notice. Neither circuit patent licenses nor indemnity are expressed or implied. Except as set forth in Clare's Standard Terms and Conditions of Sale, Clare, Inc. assumes no liability whatsoever, and disclaims any express or implied warranty, relating to its products including, but not limited to, the implied warranty of merchantability, fitness for a particular purpose, or infringement of any intellectual property right.

The products described in this document are not designed, intended, authorized or warranted for use as components in systems intended for surgical implant into the body, or in other applications intended to support or sustain life, or where malfunction of Clare's product may result in direct physical harm, injury, or death to a person or severe property or environmental damage. Clare, Inc. reserves the right to discontinue or make changes to its products at any time without notice.

Specification: DS-IXD_609-R00D
©Copyright 2010, Clare, Inc.
All rights reserved. Printed in USA.
7/7/2010