



## IRC CHP Series Handbook



TT electronics  
IRC - Wirewound & Film Technologies Division  
736 Greenway Road  
PO Box 1860  
Boone, NC 28607 USA  
1-828-264-8861

March 2003

# CONTENTS

---

## **1.0 INTRODUCTION**

- 1.1 Product History
- 1.2 Product Description

## **2.0 PRODUCT MANUFACTURE, STRUCTURE, AND QUALITY CONTROL**

- 2.1 Manufacture and Structure
- 2.2 Product Quality Control

## **3.0 PRODUCT ELECTRICAL, ENVIRONMENTAL, AND MECHANICAL CHARACTERISTICS**

- 3.1 Product Specifications
- 3.2 CHP Part Number Description
- 3.3 Power Derating
- 3.4 Surge Rating
- 3.5 Performance Characteristics
- 3.6 Product Dimensions
- 3.7 Recommended Solder Pad Dimensions
- 3.8 Soldering Methods
- 3.9 High Frequency Characteristics
- 3.10 Flammability
- 3.11 Thermal Performance

## **4.0 PRODUCT RELIABILITY ASSURANCE PROGRAM**

- 4.1 Conformance Test Program Summary
- 4.2 Standard Test Conditions and Acceptance Criteria

## **5.0 PACKAGING**

## **Appendix A. Control Plan**

## 1.0 INTRODUCTION

---

### 1.1 PRODUCT HISTORY

IRC's CHP family of surface mount resistors provides **unsurpassed power density**. From the 1206 ¼-watt product (CHP1/8) to the current development of a 2010 1-watt offering (CHP1X), global CHP customers capitalize on the inherent advantages of the CHP's proprietary materials system and construction.

The CHP surface mount resistor is a member of IRC's precision Metal Glaze™ resistor product family that has supplied billions of high-quality electronic components to the automotive, military, computer, instrumentation, telecommunications, and industrial electronics markets for over 35 years. IRC's proprietary Metal Glaze™ technology provides an inherent and unsurpassed combination of ruggedness, performance and low cost. The reliability of the Metal Glaze™ family is supported by well **over 1 billion unit hours of life testing with no failures**.

The CHP uses the same resistive element as its established-reliability, military-qualified leaded counterpart. IRC has supplied demanding customers with tens of millions of CHP resistors since introducing the product in 1980, and has experienced **no field failures**. The CHP series, as all of the Metal Glaze™ family, is manufactured in the United States at IRC's Boone, North Carolina facility, a QS-9000 registered facility.

### 1.2 PRODUCT DESCRIPTION

The CHP is a monolithic precision surface mount resistor with cylindrical geometry. The basis of the component is a Metal Glaze™ resistive element, with a capless solder termination. The component is available in several package sizes, allowing power rating between 1/8 and 2 Watts.

This unique construction not only provides a cost effective solution to common applications where reliability is a major concern, but also offers some unique features to surface mount technology. Some important characteristics of the CHP are listed below:

- ✓ The inherent ruggedness of the Metal Glaze™ element can absorb **higher voltage surges and overloads** than its thin film metal oxide/metal film and thick film flat counterparts. The CHP can withstand extreme temperatures resulting from power overloads or circuit ambient heating.
- ✓ The CHP family offers **high power density** packages, including a 1/4-watt 1206 footprint.
- ✓ The CHP1X, currently under development, is expected to offer **1-watt, 70 °C performance in a 2010** package.
- ✓ Compared to surface-mount wirewound products, the CHP is extremely **cost competitive**. IRC's CHP series is often used by designers as an

## 1.0 INTRODUCTION

---

alternative to surface-mount wirewound components, allowing IRC customers to enjoy a **30% - 60% cost savings**.

- ✓ The relatively simple design and construction of the CHP provides benefits in **long-term reliability**. The product provides solder-dipped nickel terminals, providing electrical continuity from the solder pad to the resistive element without the need for end-caps or weld-joints. The Metal Glaze™ technology provides a resistive element that is **impervious to environmental conditions** without the need for an airtight encapsulation. The cylindrical high alumina ceramic substrate provides **excellent thermal conductivity** for maximum heat dissipation and provides **superb mechanical strength** to withstand the stresses present during board assembly, mounting, and operation.
- ✓ The solder termination provides **superb solderability**. Unlike the typical MELF components that use end-cap termination there is no dog-bone shape to interfere with pick and place accuracy.
- ✓ The CHP series offers resistance values as low as  $0.050\Omega$ , providing customers with a cost-efficient, **low-inductance current sense resistor**.
- ✓ The CHP offers a **broad resistance range ( $0.050\Omega - 2.2M\Omega$ )** in a limited number of package sizes, simplifying IRC's customers manufacturing processes by reducing the number of packages required.
- ✓ Several special products are available based on this product, including **Zero ohm jumpers** (ZCHP), negative TCR components, and fully-certified military products with DSCC drawings.
- ✓ The CHP is offered with **tolerance as low as  $\pm 0.25\%$**  and **TCR as low as  $\pm 50$  PPM/°C**. These characteristics are provided without the tremendous cost premiums required of flat thick-film competitors.

IRC is committed to **quick delivery** of the CHP. Non-standard resistance values are available with a normal lead-time of 4 to 6 weeks. Expedited delivery for customer demands exceeding the normal lead-time is available.

## 2.0 PRODUCT MANUFACTURE, STRUCTURE, AND QUALITY CONTROL

---

### 2.1 MANUFACTURE AND STRUCTURE

#### 2.1.1 FIRING

The Metal Glaze™ process starts with a high-grade alumina rod. After a metal-to-glass ratio has been determined (to achieve desired resistance value), milled glaze is applied by dipping the rod and withdrawing it at a controlled rate for uniform film-thickness control

The dipped rods are then fired at approximately 1000°C. As the glass in the glaze melts and flows during firing, it creates a form of microencapsulation of the metal particles in this process, the glass also forms a strong bond with the vitreous phase in the alumina substrate

#### 2.1.2 TERMINATING

After firing, the glazed rods are masked in preparation for diamond sawing to the desired length and in preparation for several stages of chemical processing.

Following the application of a selectively plated electroless nickel termination and other treatments, the elements are robotically solder dipped. The standard termination for the CHP is 60% Sn / 40% Pb solder.

#### 2.1.3 BINNING

The elements in a firing batch are automatically sorted into lots with narrow resistance bands ("bins"). Resistors are manufactured from a sample of the batch and evaluated using a standard series of tests before acceptance of the batch. These tests cover mechanical characteristics, DC resistance, TCR, solderability and STOL. Accepted elements are then stored until needed. This lot acceptance testing allows IRC continuous monitoring of its manufacturing system.

#### 2.1.4 ADJUSTING TO FINAL RESISTANCE VALUE

When an order is placed, IRC's production staff select an appropriate "bin" to meet the customer's required resistance and TCR. The resistance value is determined by using a laser to cut a helical path, increasing resistance, while a precision resistance bridge monitors resistance. When the resistance value is reached, the equipment controller shuts off the laser and verifies that the helical conductor path covers an acceptable fraction of the element length. IRC accepts only those elements that meet resistance and helixing requirements.

#### 2.1.5 APPLYING THE DIELECTRIC COATING

A dielectric coating is applied to the resistor to seal the surface of the component from debris that could affect performance and provide a dielectric layer to the customer.

## 2.0 PRODUCT MANUFACTURE, STRUCTURE, AND QUALITY CONTROL

### 2.1.6 FINAL ELECTRICAL TEST AND PREPARATION FOR SHIPMENT

For the final stages of the process, the coated and spiraled element is tested to ensure electrical tolerance requirements are met. Depending upon the resistance value, a high voltage overload is applied to the element before the electrical test to enhance product stability

After the test operation, the finished resistors are subjected to a Quality Audit using a "Zero" defect sampling plan to ensure conformance to visual, mechanical, and electrical requirements. Accepted product then advances to the packaging operation.

Note: The processes described above include the use of many proprietary materials and techniques and are protected by IRC patents.

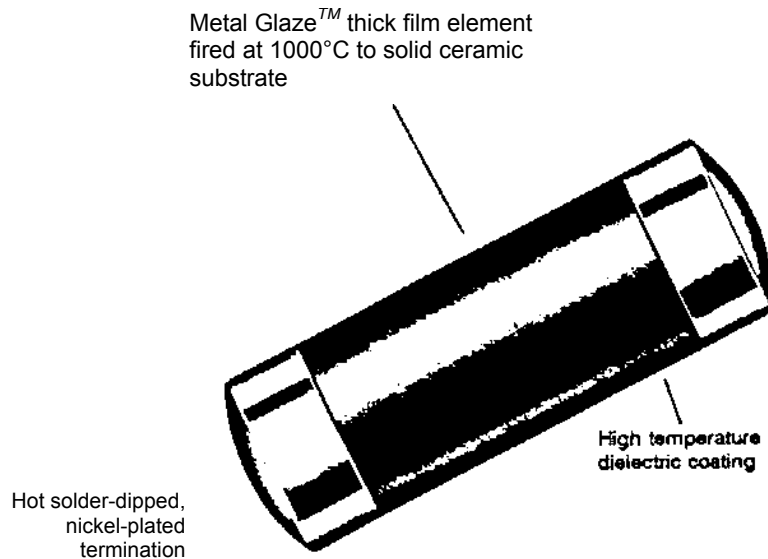

## 2.2 PRODUCT QUALITY CONTROL

It is the policy of IRC to be the industry leader in product quality. The company creates an atmosphere and cultivates an attitude to motivate its employees to their highest potential of excellence. We have a long-term goal of producing product with zero defects and pursue a strategy of continual improvement of our products and services to achieve that goal.

This policy and related goals are incorporated in the CHP process to ensure the customer receives the quality product it needs, when it needs it, and at a competitive price.

IRC adopts and practices the latest and most advanced control techniques available. These include all the various applications of statistical process control (SPC). The company expresses the results of its efforts in parts per million (PPM), anticipating a period when it will report its results in parts per billion (PPB).

## 2.0 PRODUCT MANUFACTURE, STRUCTURE, AND QUALITY CONTROL

---

IRC has attained leading facility and process quality certifications, including a MIL-qualified environmental test lab, QS-9000 registration, and Ford's Q1 qualification.

The CHP product is manufactured in accordance with documented Process Control Plans. The plan provides for control of the entire process from raw material inspection to packing and shipping. Special attention is paid to providing complete and accurate paperwork.

In-process control of quality is maintained by technicians, operators and maintenance personnel and is monitored at checkpoints in the process by the quality control department. IRC has developed a unique inline process average test (PAT) program that electrically stresses 100% of the components and screens out components that underperform expected statistical results.

Appendix A presents the complete Process Control Plan for the CHP family.

### 3.0 PRODUCT ELECTRICAL, ENVIRONMENTAL, AND MECHANICAL CHARACTERISTICS

#### 3.1 PRODUCT SPECIFICATIONS

Industry Footprint	IRC type	Maximum Power Rating	Working Voltage <sup>1</sup>	Max. Voltage	Resistance Range <sup>2, 3</sup>	Tolerance <sup>2</sup> (±%)	TCR (PPM/°C)	Product Category
1206	CHP1/8	1/4W @ 70°C	200	400	0.1Ω - 0.99Ω	1, 2, 5	100	Low Range
					1.0Ω - 1 MΩ	1, 2, 5	50, 100	Standard
					20Ω - 348KΩ	0.25, 0.5	50, 100	Tight Tolerance
2010	CHP1/2	1/2W @ 70°C	300	600	0.1Ω - 0.99Ω	1, 2, 5	100	Low Range
					1.0Ω - 348KΩ	1, 2, 5	50, 100	Standard
2512	CHP1	1W @ 70°C	350	700	0.1Ω - 0.99Ω	1, 2, 5	100	Low Range
					1.0Ω - 2.21 M	1, 2, 5	50, 100	Standard
					20Ω - 350KΩ	0.25, 0.5	50, 100	Tight Tolerance
3610	CHP2	2W @ 70°C, 1.33W @ 70°C	500	1000	0.2Ω - 0.99Ω	1, 2, 5	100	Low Range
					1.0Ω - 2.21MΩ	1, 2, 5	50, 100	Standard

<sup>1</sup>Not to exceed SQRT(PXR)

<sup>2</sup>Consult factory for tighter TCR, tolerance, or resistance values not listed

<sup>3</sup>Zerohm CHPs available for each product type

#### 3.2 CHP PART NUMBER DESCRIPTION

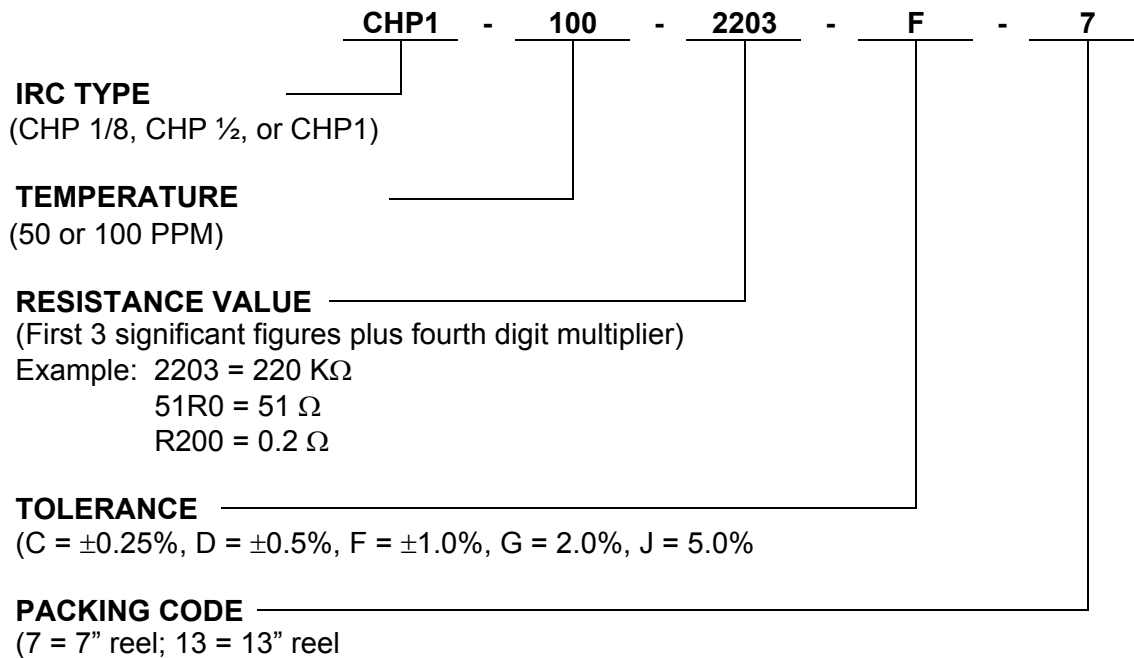



### 3.0 PRODUCT ELECTRICAL, ENVIRONMENTAL, AND MECHANICAL CHARACTERISTICS

#### 3.3 POWER DERATING

CHP POWER DERATING CURVE

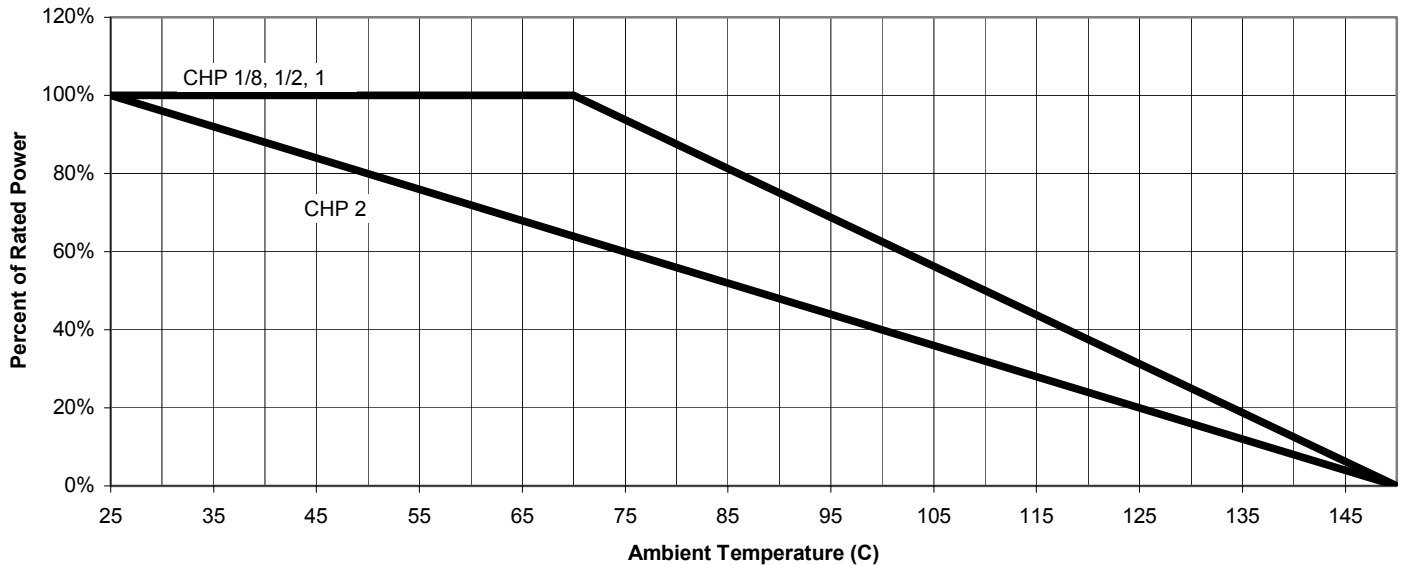

#### 3.4 SURGE RATING

The CHP demonstrates far superior surge performance to competing surface mount film products. The reason for this performance stems from the mass of the deposited film. In short duration (microseconds to milliseconds) overvoltage events typical of transient voltage spikes, the heat from the power dissipation must be borne by the resistive film. In these situations, the mass of the film is the critical feature for survival.

Metal film or metal oxide components are sputtered or evaporated, resulting in a “thin film” of resistance material. The CHP resistance material is applied in a dipping process, leaving a much thicker (typically 5 – 10 times thicker) film. The mass, therefore surge capacity, of the CHP is accordingly higher.

The cylindrical geometry of the CHP provides an inherent surge advantage to flat “thick film” surface mount components. Film mass, proportional to deposited area, is predictably greater on a cylindrical CHP product component than on a flat product. Flat components are manufactured by depositing material on only one side of the substrate. The area of the printed film is approximately  $W \times L$ , where  $W$  represents the element width, and  $L$  represents the element length. For a cylindrical component, where the film coats the entire surface of the component, the area of the film is approximately  $\pi \times W \times L$ . Comparison shows the CHP to have roughly 3 times the material as a flat thick film product, explaining the CHP’s performance advantage over flat thick film chip resistors.

IRC has developed two surge charts presenting the surge capacity of the CHP. The charts vary based on the repetitive nature of the surge events. If the component is subject to a continuous string

### 3.0 PRODUCT ELECTRICAL, ENVIRONMENTAL, AND MECHANICAL CHARACTERISTICS

of repetitive surges but the time-weighted average power does not exceed the rated power of the component, the user should refer to the repetitive surge chart. If the surges are more isolated, the user should refer to the non-repetitive surge chart. In cases where the component will see a repeated pattern of multiple surges but each cluster of surges is relatively isolated, the user should consult IRC's application engineering department for assistance.

In addition to limits on the component based on power dissipation, it is also important to note that the component may reach voltage or current limits. CHP maximum voltage and current values are shown below:

Size	Range	Max Peak Voltage (V) <sup>1</sup>	Max Peak Current (Amps) <sup>2</sup>
CHP1/8	≤ 3 KΩ	1200	75
	> 3 KΩ	400	N/A
CHP1/2	≤ 3 KΩ	1800	150
	> 3 KΩ	600	N/A
CHP1	≤ 3 KΩ	2100	300
	> 3 KΩ	700	N/A
CHP2	≤ 3 KΩ	3000	500
	> 3 KΩ	1000	N/A

<sup>1</sup>The maximum peak current only becomes a limitation for resistor values below approximately 16Ω. For example: an 0.5Ω CHP1 would draw 4200A at 2100V. As the maximum peak current is 300A, the maximum peak voltage is determined by the equation:  $V_{peak} = I_{peak} \times R$ . In this case  $V_{peak} = 300 \times 0.5 = 150$  Volts

<sup>2</sup>For mid to high resistor values (above 3 KΩ) the peak voltage applied becomes a more important consideration than power or current (which are limited by the high resistance value). Unlike the effect of power and current which causes a positive and potentially destructive change in resistance, the effect of excess voltage on mid- to high-range resistors is a negative change in resistance. While this is not harmful to any of the properties of the resistor, the shift in resistance value may affect circuit performance. By staying below the peak voltage indicated for values above 3 KΩ, the expected change in resistance will be less than 0.25%.

### 3.0 PRODUCT ELECTRICAL, ENVIRONMENTAL, AND MECHANICAL CHARACTERISTICS

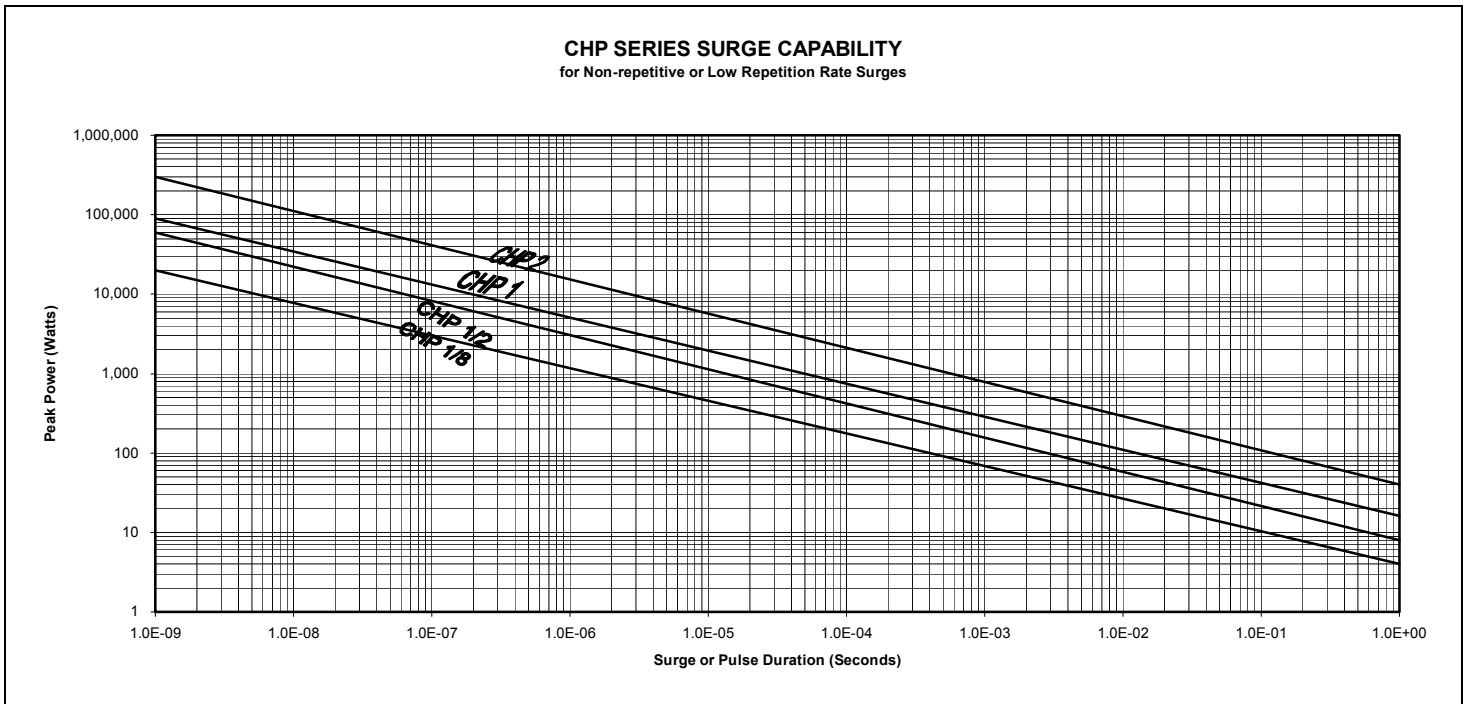
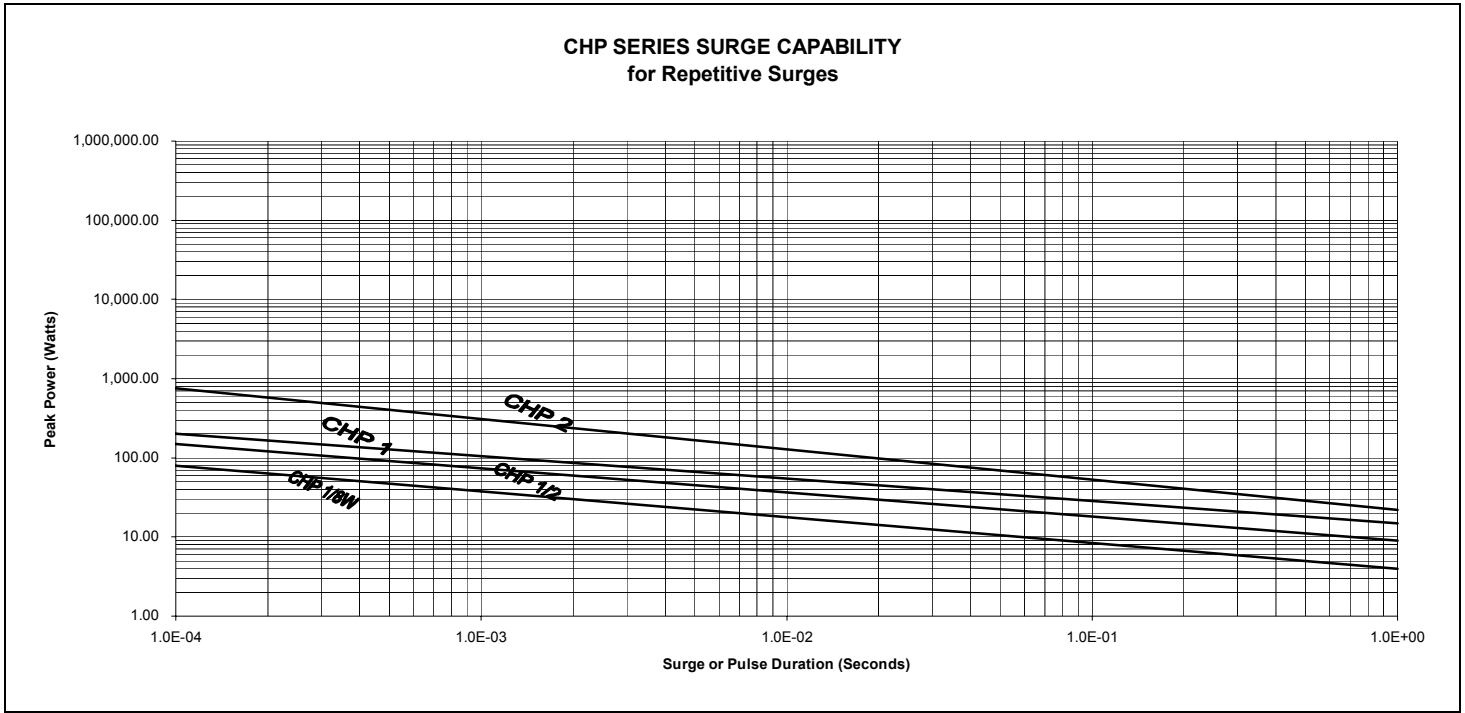

### 3.0 PRODUCT ELECTRICAL, ENVIRONMENTAL, AND MECHANICAL CHARACTERISTICS

#### 3.5 PERFORMANCE CHARACTERISTICS

CHARACTERISTICS	MAXIMUM CHANGE	TEST METHOD
Temperature Coefficient	As specified	MIL-PRF-55342E Par 4.7.9 -55°C to +125°C
Thermal Shock	$\pm 0.5\% + 0.01 \Omega$	MIL-PRF-55342E Par 4.7.3 -65°C to +150°C, 5 cycles
Low Temperature Operation	$\pm 0.25\% + 0.01 \Omega$	MIL-PRF-55342E Par 4.7.4 -65°C @ working voltage
Short Time Overload	$\pm 0.25\% + 0.01 \Omega (R \leq 100K\Omega)$ $\pm 1\% + 0.01 \Omega (R > 100K\Omega)$	MIL-PRF-55342E Par 4.7.5 2.5 x SQRT(PxR) for 5 seconds
High Temperature Exposure	$\pm 0.5\% + 0.01 \Omega$	MIL-PRF-55342E Par 4.7.6 +150°C for 100 Hours
Resistance to Bonding Exposure	$\pm 0.25\% + 0.01 \Omega$	MIL-PRF-55342E Par 4.7.7 Reflow soldered to board at 260°C for 10 seconds
Solderability	95% Minimum Coverage	MIL-STD-202, Method 208 245°C for 5 seconds
Moisture Resistance	$\pm 0.5\% + 0.01 \Omega$	MIL-PRF-55342E Par 4.7.8 10 cycles, total 240 hours
Life Test	$\pm 0.5\% + 0.01 \Omega$	MIL-PRF-55342E Par 4.7.10 2000 hours at 70°C intermittent
Terminal Adhesion Strength	$\pm 1\% + 0.01 \Omega$ No Mechanical Damage	1200 gram push from underside of mounted chip for 60 seconds
Resistance to Board Bending	$\pm 1\% + 0.01 \Omega$ No Mechanical Damage	Chip mounted in center of 90mm long board, deflected 5mm so as to exert pull on chip contacts for 10 seconds

### 3.0 PRODUCT ELECTRICAL, ENVIRONMENTAL, AND MECHANICAL CHARACTERISTICS

#### 3.6 PRODUCT DIMENSIONS

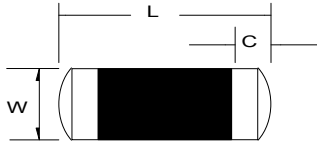
INDUSTRY FOOTPRINT	IRC TYPE			
		L	W	C
1206	CHP 1/8	0.126 +0.010 -0.005 (3.2 + 0.25 - 0.15)	0.057 ± 0.006 (1.45 ± 0.15)	0.020 ± 0.010 (0.51 ± 0.25)
2010	CHP 1/2	0.200 ± 0.010 (5.08 ± 0.25)	0.079 ± 0.006 (2.01 ± 0.15)	0.030 ± 0.010 (0.76 ± 0.25)
2010	CHP 1X <sup>1</sup>	0.200 ± 0.010 (5.08 ± 0.25)	0.079 ± 0.006 (2.01 ± 0.15)	0.030 ± 0.010 (0.76 ± 0.25)
2512	CHP 1	0.251 ± 0.010 (6.38 ± 0.25)	0.057 ± 0.006 (1.45 ± 0.15)	0.040 ± 0.010 (1.02 ± 0.25)
3610	CHP 2	0.367 ± 0.010 (9.32 ± 0.25)	0.105 ± 0.006 (2.67 ± 0.15)	0.050 ± 0.010 (1.27 ± 0.25)

<sup>1</sup>The CHP 1X is a product under development.

#### 3.7 RECOMMENDED SOLDER PAD DIMENSIONS

The proper solder pad size and geometry is dependent upon the type of soldering process used, the size and type solder fillet expected to form on the CHP terminal and the power handling capability expected of the CHP resistor.

The recommended solder pad design (shown below) will provide a large repeatable solder fillet to the CHP resistor on IR and vapor phase reflow processes and will provide maximum heat transfer to the PC board in high power applications.

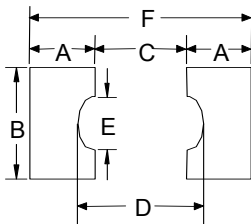

Industry Footprint	IRC Type	Dimensions – Inches and (mm)					
		A	B	C	D	E	F
1206	CHP 1/8	0.076 (1.93)	0.093 (2.36)	0.058 (1.47)	0.098 (2.49)	0.032 (0.81)	0.211 (5.36)
2010	CHP ½	0.111 (2.82)	0.126 (3.20)	0.096 (2.44)	0.152 (3.86)	0.040 (1.02)	0.318 (8.08)
2010	CHP 1X <sup>1</sup>	0.111 (2.82)	0.126 (3.20)	0.096 (2.44)	0.152 (3.86)	0.040 (1.02)	0.318 (8.08)
2512	CHP 1	0.121 (3.07)	0.126 (3.20)	0.127 (3.23)	0.183 (4.65)	0.040 (1.02)	0.369 (9.37)
3610	CHP 2	0.170 (4.32)	0.200 (5.08)	0.213 (5.41)	0.273 (6.93)	0.044 (1.12)	0.553 (14.05)

<sup>1</sup>The CHP 1X is a product under development.

## 3.0 PRODUCT ELECTRICAL, ENVIRONMENTAL, AND MECHANICAL CHARACTERISTICS

---

### 3.8 SOLDERING METHODS

***The Rolling Myth:*** Despite the excellent production results enjoyed by the consumers of hundreds of millions of CHPs, some customers are hesitant to accept a cylindrical component. By placing the CHP on the solder paste while the paste is in the tacky state, the CHP will be held in position until solder reflow begins. The pad design then uses the surface tension of the molten solder to pull the component to the center of the solder pad. The excessive vibration that would be required to initiate rolling from a CHP would also be associated with a number of soldering problems for today's fine-pitched surface mount components. IRC application engineers are available upon request to assist customers in issues from circuit layout through component placement and soldering.

***Recommended Soldering Practices:*** IRC's customers have enjoyed success at a number of soldering methods, including reflow, wave, and hand soldering. However, it is IRC's experience that infrared (IR) reflow soldering yields the most consistent high-quality solder fillets. Soldering practices for several styles of soldering are presented below:

#### 3.8.1 General Design and Assembly

General statement of best practices: Use IRC's solder pad, avoid mechanical shock and flexure, and avoid use of high-CTE substrates.

*Solder Pads:* IRC strongly encourages use of the recommended solder pad. The C-shaped cutout or notch assists in self-centering the component and in forming an optimum solder fillet.

*Mechanical shock:* Mechanical stress can be imparted to the component through mechanical shock in a number of ways. If board assembly is performed in a "multi-up" format, prior to circuit board singulation, care must be taken not to flex the circuit during singulation. Additionally, board flexure can take place while assembling a large connector or other component to the board, or while inserting the circuit board into an edge connector or other mounting fixture.

*PCB:* IRC's customers typically enjoy good success in soldering the CHP series to high-quality board substrates like FR-4. Lower-quality substrates with high coefficients of thermal expansion (CTEs) can lead to difficulties with all ceramic components.

#### 3.8.2 Reflow

General statement of best practices: Infrared reflow is the most successful soldering method for the CHP series. The customer should ensure that sufficient solder is available. Care should be taken to ensure that adequate heat is applied to the component.

*Stencil Thickness:* IRC's recommended solder stencil thickness is 0.007" (0.18 mm). The minimum stencil thickness is 0.005" (0.13 mm). Less solder can lead to insufficient solder fillet volume.

### 3.0 PRODUCT ELECTRICAL, ENVIRONMENTAL, AND MECHANICAL CHARACTERISTICS

*Placement Location:* If the component is placed on the edge of the circuit board, ensure that the temperature profile across the board is consistent. Insufficient heating can lead to a substandard solder joint.

*Shadowing:* If the customer is using infrared (IR) reflow, large components can shield the CHP from heating radiation. This shielding can cause insufficient heating and reflow of the solder joint.

*Reflow temperature profile:* Customers are advised to follow IRC's reflow temperature curve (provided below)

*Reflow Method:* Infrared reflow is the recommended assembly method. Other types of reflow may be used, but IR reflow is the most commonly used method among IRC's customers.

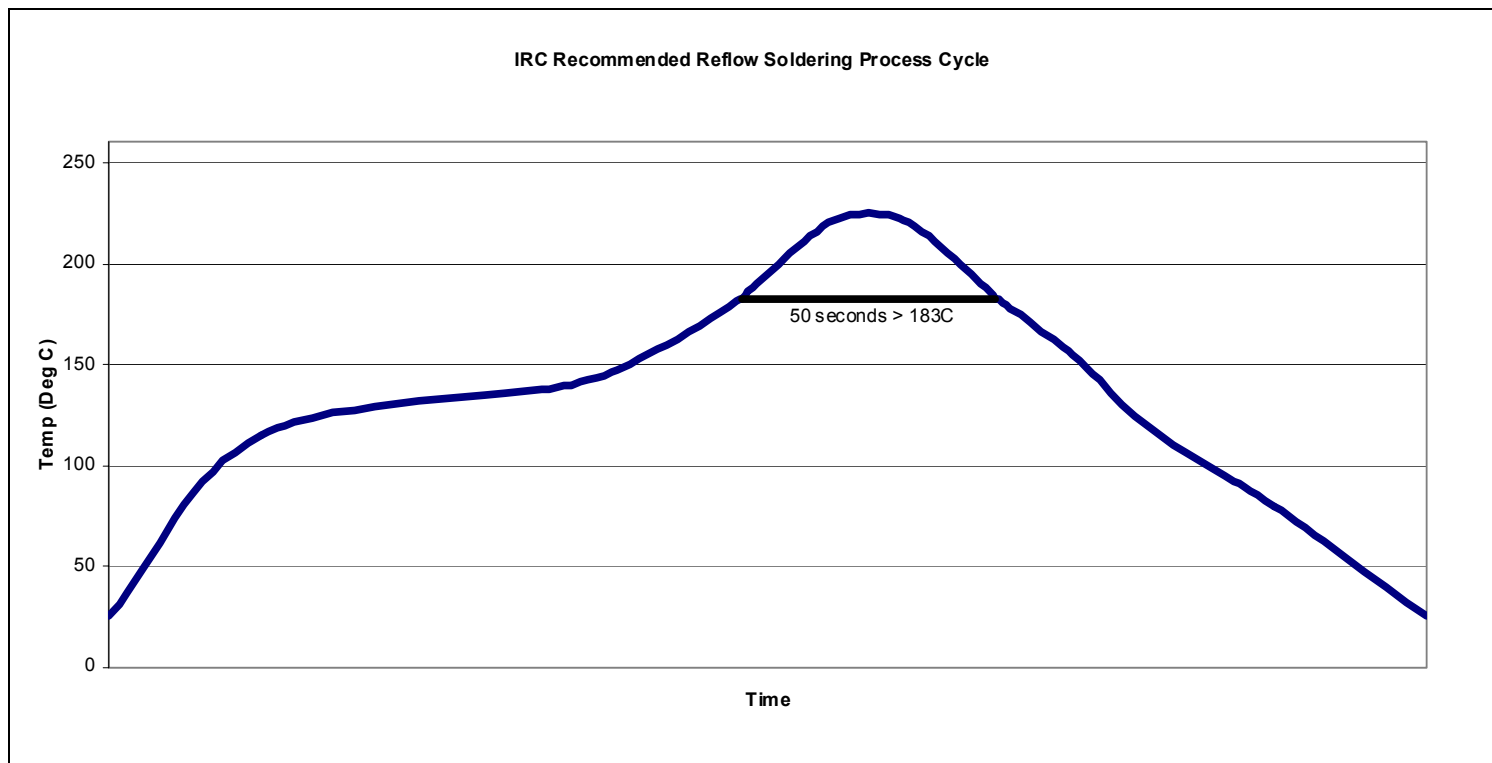

#### 3.8.3 Wave Solder

General statement of best practices: IRC has noted a significant decrease in the use of wave soldering over the past several years, as many customers have switched to reflow soldering as a more reliable system. Minimize the size of adhesive dots to avoid mechanical stresses from TCE mismatch between adhesives and the component.

*Glue dots:* The TCE mismatch between adhesives used for wave soldered components leads to mechanical stress in the Z-axis, perpendicular to the circuit board. Minimizing the quantity of adhesive applied will minimize this stress.

## 3.0 PRODUCT ELECTRICAL, ENVIRONMENTAL, AND MECHANICAL CHARACTERISTICS

---

### 3.8.4 Hand solder/Rework

General statement of best practices: Hand-soldering is the most difficult to control method of assembly and should be avoided if possible. If hand soldering is unavoidable, a temperature-controlled soldering iron should be used (tweezer type if available), and operators should be trained to avoid imparting excessive mechanical stress to the part. Alternatively, pneumatic dispensers are useful to dispense a controlled amount of solder. In these cases, the solder is usually reflowed by forced air.

*Mechanical damage:* A manual soldering iron provides a substantial (although undesired) lever, and can easily damage the component or circuit board. This may be avoided by properly training the operator in appropriate soldering technique.

*Excessive heat / exposure:* Tweezer-style soldering irons may be used to heat both terminals simultaneously, avoiding some types of overheating. When possible, use a soldering iron with digitally controlled temperature control.

*Solder paste dispense/reflow:* As an alternative to hand soldering, rework can be completed by using a pneumatic dispenser to deposit a controlled amount of solder paste on the PCB. Reflow is performed usually by directed hot air flow or by IR reflow

## 3.9 HIGH FREQUENCY CHARACTERISTICS

For IRC CHP products below  $150\Omega$ , the high frequency model looks like a resistor with a small amount of effective series inductance. The inductance varies with the helix path required in value adjustment manufacturing step (see Section 2.1.4) and material selection. However, some generalizations are appropriate, and are provided below.

For resistance values below  $30\Omega$ , the series inductance has a value of 3-10 nanohenries (nH) for the CHP1/2 and CHP1/8 and 6-15 nH for the CHP1 and CHP2.

For values between  $30\Omega$  -  $80\Omega$ , the amount of inductance reaches its maximum value at a level of 10-15 nH for the CHP1/8 and CHP1/2 and 15-20 nH for the CHP1 and CHP2. These maximum values may be lowered to the levels below  $30\Omega$  by using special spiraling method for the customers requiring optimum high frequency performance.

From  $80\Omega$ - $150\Omega$ , the series inductance falls off to zero as the capacitive effects of the film dominates.

For IRC CHP products above  $150\Omega$ , the HF model becomes a resistor shunted by a very small capacitance. The effective value is 0.1 picofarad (pF) for the CHP1/8 and CHP1/2, and 0.15 pF for the CHP1 and CHP2.

## 3.10 FLAMMABILITY

Because the dielectric coating of the CHP is very thin, the CHP is nearly 100% inorganic; hence, the flammability of the product is very low. The CHP qualifies as a UL-V0 component.



### 3.0 PRODUCT ELECTRICAL, ENVIRONMENTAL, AND MECHANICAL CHARACTERISTICS

#### 3.11 THERMAL PERFORMANCE

The CHP's high-grade alumina core provides excellent thermal transfer, resulting in even temperature across the component. The CHP thermal impedance ( $^{\circ}\text{C}/\text{watt}$ ) is lower than or equal to competing technologies, as shown in the figure below.

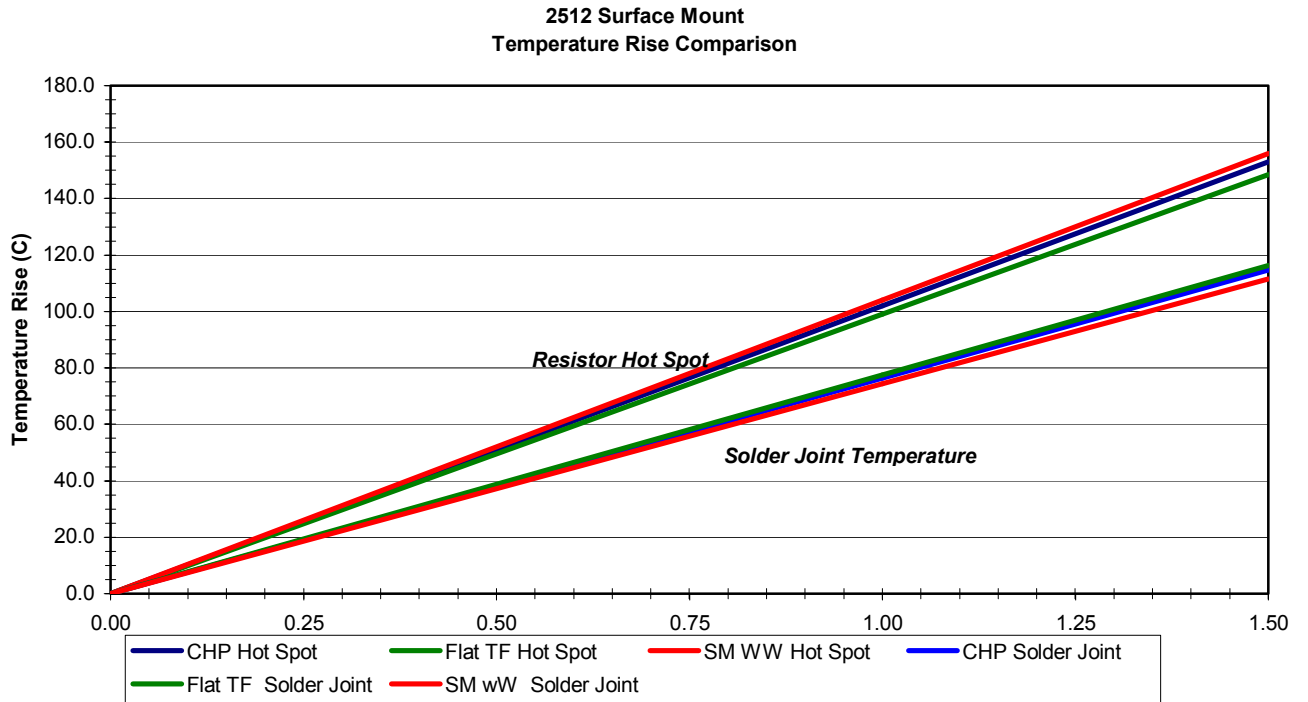

## 4.0 PRODUCT RELIABILITY ASSURANCE PROGRAM

### 4.1 CONFORMANCE TEST PROGRAM SUMMARY

In addition to various controls built into the CHP process to ensure product reliability, a test program has been set-up to randomly monitor the performance of the CHP product. IRC maintains the data from the conformance test program and will provide these data to customers upon request. The following summary describes the performed tests. The following Chart summarizes this monitoring system:

Characteristics	Maximum Change	Test Method	Test Frequency
Temperature Coefficient	By TCR requirements	MIL-PRF-55342E Par. 4.7.9 -55°C to +125°C	Weekly
Thermal Shock	$\pm 0.5\% + 0.01\Omega$	MIL-PRF-55342E Par. 4.7.3 -65°C to +150°C, 5 cycles	Monthly
Low Temperature Operation	$\pm 0.25\% + 0.01\Omega$	MIL-PRF-55342E Par. 4.7.4 -65°C at working voltage	Weekly
Short Time Overload	$\pm 0.25\% + 0.01\Omega$ (R $\leq$ 100 K $\Omega$ ) $\pm 1.0\% + 0.01\Omega$ (R $>$ 100 K $\Omega$ )	MIL-PRF-55342E Par. 4.7.5 2.5 x SQRT(PxR) for 5 sec	Weekly
High Temperature Exposure	$\pm 0.5\% + 0.01\Omega$	MIL-PRF-55342E Par. 4.7.6 +150°C for 100 hours	Quarterly
Resistance to Bonding Exposure	$\pm 0.25\% + 0.01\Omega$	MIL-PRF-55342E Par. 4.7.7 Reflow soldered to board at 260°C for 10 seconds	Weekly
Solderability	95% minimum coverage	MIL-STD-202, Method 208 245°C for 5 seconds	Monthly
Moisture Resistance	$\pm 0.5\% + 0.01\Omega$	MIL-PRF-55342E Par. 4.7.8 10 cycles, total 240 hours	Quarterly
Life Test	$\pm 0.5\% + 0.01\Omega$	MIL-PRF-55342E Par. 4.7.10 2000 hours at 70°C intermittent	Quarterly

### 4.2 STANDARD TEST CONDITIONS AND ACCEPTANCE CRITERIA

#### 4.2.1 RESISTANCE VALUE

Procedure: Measurements to be made at 25°C  $\pm$ 2°C (MIL-PRF-55342 para. 4.7.2)

Acceptance criteria: Reading must be within the specified tolerance at the nominal value.

#### 4.2.2 TEMPERATURE COEFFICIENT

Procedure: Readings to be taken at 25°C -55°C, 25°C, 125°C MIL-PRF-55342 para. 4.7.3)

Acceptance criteria: Reading must not exceed criteria as specified in the applicable plan drawing

#### 4.2.3 THERMAL SHOCK

Procedure: 5 cycles from -65°C to 150°C. MIL-PRF-55342 para. 4.7.3)

Acceptance criteria: Change in resistance from the initial reading not to exceed  $\pm 0.5\% \pm 0.01\Omega$ .

#### 4.2.4 LOW-TEMPERATURE OPERATION

Procedure: Expose to -85°C for one hour Load at full rated continuous working voltage for 45 min. Power off for 15 min. (MIL-PRF-55342 para. 4.74)

## 4.0 PRODUCT RELIABILITY ASSURANCE PROGRAM

---

Acceptance criteria: Change in resistance from the initial reading not to exceed  $\pm 0.25\%$   $+0.01\Omega$

### 4.2.5 SHORT-TIME OVERLOAD

Procedure: Apply 2.5 times the rated continuous working voltage for 5 seconds. (MIL-PRF-55342 para. 4.7.5)

Acceptance criteria: Change in resistance not to exceed  $\pm 0.25\%$   $+0.01\Omega$  for values less than  $100K\Omega$  and not to exceed  $\pm 1.0\%$  for values above  $100K\Omega$ .

### 4.2.6 HIGH-TEMPERATURE EXPOSURE

Procedure: Expose to  $+150^{\circ}\text{C}$  for 100 hours (MIL-PRF-55342 para. 4.7.6)

Acceptance Criteria: Change in resistance not to exceed  $\pm 0.5\%$   $+0.01\Omega$

### 4.2.7 RESISTANCE TO BONDING EXPOSURE

Procedure: Reflow solder to board at  $260^{\circ}\text{C}$  for 10 seconds (MIL-PRF-55342 para. 4.7.7)

Acceptance Criteria: Change in resistance not to exceed  $\pm 0.25\%$   $+0.01\Omega$

### 4.2.8 SOLDERABILITY

Procedure: Immerse resistor in flux for 5 seconds, immerse in  $245^{\circ}$  solder for 5 seconds. (MIL-PRF-55342 para. 4.7.11)

Acceptance Criteria: Solderable area to be 95% covered by new solder

### 4.2.9 MOISTURE RESISTANCE

Procedure: Apply 10 cycles for a total of 240 hours (MIL-PRF-55342 para. 4.7.8)

Acceptance Criteria: Change in resistance not to exceed  $\pm 0.5\%$   $+0.01\Omega$

### 4.2.10 LIFE TEST

Procedure: Intermittent load for 2000 hours at  $70^{\circ}\text{C}$ . (MIL-PRF-55342 para. 4.7.10)

Acceptance Criteria: Change in resistance not to exceed  $\pm 0.5\%$   $+0.01\Omega$

### 4.2.11 TERMINAL ADHESION STRENGTH

Procedure: Apply 1200 gram push from underside of mounted CHP for 60 seconds.

Acceptance Criteria: Change in resistance not to exceed  $\pm 1.0\%$   $+0.01\Omega$  and no mechanical damage.

### 4.2.12 RESISTANCE TO BOARD BENDING

Procedure: CHP mounted in center of 90 mm long board and deflected 5 mm so as to exert pull on CHP contacts for 10 seconds.

Acceptance Criteria: Change in resistance not to exceed  $\pm 1.0\%$   $+0.01\Omega$  and no mechanical damage.

## 5.0 PACKAGING

---

CHP resistors are reel taped on standard 4mm pitch anti-static plastic embossed tape in accordance with the requirements of EIA 481 to support high speed automated component feeding processes. The chart below summarizes the reel sizes, number of components per reel and carrier tape width for the CHP product family.

<b>INDUSTRY FOOTPRINT</b>	<b>IRC TYPE</b>	<b>REEL DIAMETER</b>	<b>QUANTITY PER REEL</b>	<b>CARRIER TAPE WIDTH</b>
1206	CHP1/8	7"	2,500 max.	7 Mm
		13"	10,000 max.	8 mm
2010	CHP1/2	7"	1,500 max.	12 mm
		13"	5,000 max.	12 mm
2512	CHP 1	7"	1,500 max.	12 mm
		13"	5,000 max.	12 mm
3610	CHP 2	13"	1,500 max.	24 mm

# Appendix A. Quality Control Plan

## CONTROL PLAN

IRC, INC.  
BOONE, NC

Control Plan Category			Key Contact Name/Phone <b>Jerry Garland</b> <b>828-264-8861</b>				Date (Orig) <b>12/18/90</b>		Date (Rev) <b>2-26-02</b>		Page	
Control Plan Number <b>N/A</b>			Core Team <b>QC/Eng./Mfg.</b>				Customer Engineering Approval (If Req'd) <b>N/A</b>				Date (If Req'd)	
Part Number <b>CHP 1/8, 1 &amp; 2 Watt</b>		ECL	Supplier / Plant Approval / Date <b>12/18/90</b>				Customer Quality Approval (If Req'd) <b>N/A</b>				Date (If Req'd)	
Part Name / Description <b>CHP Resistor Series (Generic)</b>			Other supplier approval by (If Req'd) <b>N/A</b>				Other Approval (If Req'd) <b>N/A</b>				Date (If Req'd)	
Supplier / Plant <b>Boone, NC</b>		Supplier Code		Other Approval Date (If Req'd) <b>N/A</b>								
Part / Proc #	Process Name / Operation description	Machine, Device, Jig, Tools For Mfg.	Characteristics				Methods					Reaction Plan
			No.	Product	Process	Special Char. Class.	Product / Process Specification / Tolerance	Evaluation / Measurement Technique	Sample Size	Sample Freq.	Control Method	
1	Receiving Inspection	N/A	A	Visual/Mechanical		N/A	Print Dimension/ Specification	Calipers/Comp Lab Evaluation	C=0	Each Lot	Inspection Data/Lab Results	Reject lot, return to vendor for corrective action.
2	Glaze Preparation	N/A	B	Glaze Viscosity		N/A	Nominal ± 15	Viscometer	1	Twice per shift	X&R Control Chart	Adjust Viscosity per MP-3610-12-0100 (Eng. Assistance).
3	Glaze Application (Rod Dip)	Glaze Dip Station	C		Dip Rate	N/A	Specified Tolerance Per Size	Stop Watch	4	Once Per Shift	X&R Control Chart	Adjust machine speed per MP-3610-12-0300
4	Glaze Firing	Kiln	D	Glaze Thickness		N/A	0.0004 - 0.0016	Micrometer	5	Hour	X&R Control Chart	Adjust kiln temperature/glaze viscosity per MP-3610-12-0400 and QC-3610-12-0400 (Eng. Assistance).
4	Glaze Firing	Kiln	E	Rod Resistance		N/A	Specified Tolerance Per Glaze Type	Resistance Bridge	10	Hour	Control Log Histogram	Adjust kiln temperature/glaze viscosity per MP-3610-12-0400 and QC-3610-12-0400 (Eng. Assistance).

## Appendix A. Quality Control Plan

5	Rod Potting	Potting Molds/P-9 Gun	F		P-9 Temperature/ Percent Shrinkage	N/A	72 - 84° F/ 0.20 - 0.90%	Thermometer/ Calipers	1	Once Per Shift	Control Log	Adjust temperature/mixture per MP-3610-13-0400 (Eng. Assistance).
6	Rod Sawing	Saw	G	Wafer Thickness		N/A	Specified Tolerance Per Size	Digital Indicator	10 Each Head	Set-Up/ Blade Chnge	X&S Control Chart	Change gears/saw blade per MP-3610-14-0100
6	Rod Sawing	Saw	H		Saw Cut Speed	N/A	Specified Tolerance Per Size	Stop Watch	1	Once Per Shift	Control Log	Adjust machine speed per MP-3610-14-0100.
7	Etch Back	Etch Back Tanks	I	Etch Back Thickness		N/A	Specified Tolerance Per Size	Calipers	5	Once Per Shift	X&R Control Chart	Adjust etch back time per MP-3610-15-0200 (Eng. Assistance).
8	Slug Tinning	Solder Dip Machines	J		Solder Temperature	N/A	285 ± 10° C 60/40 Solder	Computer Readout	1	Once Per Shift	Control Log	Adjust process per MP-3610-16-0100 and QC-3610-16-0100
8	Slug Tinning	Solder Dip Machines	K		Flux Specific Gravity	N/A	N/A	Computer Readout	1	Once Per Shift	Control Log	Adjust process per MP-3610-16-0100 and QC-3610-16-0100
8	Slug Tinning	Solder Dip Machines	L		Dwell Time	N/A	Specified Value Per Size	Stop Watch	1	Once Per Shift	Control Log	Adjust process per MP-3610-16-0100 and QC-3610-16-0100
9	Slug Culling	Cullers	M	Slug Diameter		N/A	Specified Tolerance Per Size	Mechanical Screening	100%	100%	Follow MP-3610-17-0200	Review/correct process (Eng. Assistance).
10	Slug Binning	Biners	N	Slug Length		N/A	Specified Tolerance Per Size	Electronic Measurement System	100%	100%	Follow MP-3610-18-0100	Review/correct process (Eng. Assistance), 100% re-bin lot.
11	Department 20 Spotcheck	N/A	O	Visual/Electrical/ Mechanical/GLA		N/A	Zero Defects	Visual/Res. Bridge/Lab Evaluation	Per Proce dures	Each Lot	Follow QCP-3610-18-0X00	Review inspection data/correct process (Eng./QC).
12	Spiraling	Spiraler	P	DC Resistance		N/A	Specified Tolerance	ESI Resistance Bridge	5	Three Per Shift	X&R Control Chart	Adjust spiraler per MP-3610-19-0402
13	Coating	Coater	Q	Dielectric Strength		N/A	125 VAC Minimum	Dielectric Tester	10	Each Order	Review Inspection Data	Adjust coater per MP-3610-24-0220, 100% re-coat lot.

## Appendix A. Quality Control Plan

14	Visual Inspection	N/A	R	Visual/ Mechanical	N/A	Zero Defects	Calipers/ Microscope	C=0	Each Order	Follow QC- 3610-34- 0100C	Review inspection data/correct process (Eng./QC).
15	Packaging	Test/Tape	S	Tape Peel Strength	N/A	10 - 63 Gr.	Peel Strength Tester	1	Set- Up/ Tape Chnge	X&R Control Chart	Adjust taping machine per MP-3610-37-0500
15	Packaging	Test/Tape	T	Short Time Overload	N/A	Zero Defects	STOL Equipment	100%	100%	Follow MP- 3610-24-0230	Review process/correct deficiency (Eng.)
15	Packaging	Test/Tape	U	DC Resistance	N/A	Specified Tolerance	Resistance Tester	100%	100%	Follow MP- 3610-24-0230	Review process/correct deficiency (Eng.)
16	Electrical Inspection	N/A	V	DC Resistance	N/A	Zero Defects	ESI Resistance Bridge	C=0	Each Order	Follow QC- 3610-34- 0100C	Review inspection data/correct deficiency (Eng./QC).
17	Dock Audit	N/A	W	Visual/Packaging/Clerical	N/A	Zero Defects	Visual	100%	Each Order	Follow QC- 3610-40-0100	Review process/correct deficiency.

**TT electronics**  
**IRC - Wirewound & Film Technologies Division**  
**736 Greenway Road**  
**PO Box 1860**  
**Boone, NC 28607 USA**