

TA-I	Thick Film Chip Resistors (Lead – Free for RM series standard)	No	TRM-XX0S001J
		page	1/13

1. Scope :

This specification applies for the RM series of thick film chip resistors made by TA-I.

2. Construction:

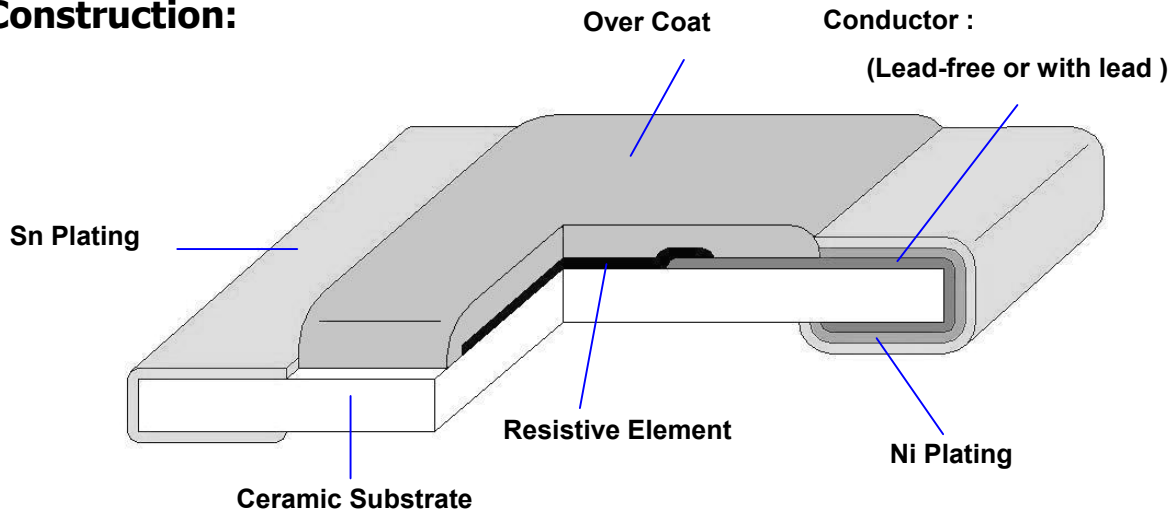

3. Type Designation:

RM **10** **J** **TN** **103**
Product Code **Size** **Tolerance** **Packaging** **Nominal Resistance**
RM : Chip Resistor **Power Rating** **Resistance**

02-0201(0603) 1/20W	J-±5%	T-Paper Tape	3 digits, e.g.,: (E-24) 103 = 10 ³ Ω = 10kΩ 0 = 0Ω
04-0402(1005) 1/16W	G-±2%	E-Embossed Tape	
06-0603(1608) 1/10W	F-±1%	B-Bulk Cassette	4 digits, e.g., : (E-96) 1540 = 154Ω 43R2 = 43.2Ω
10-0805(2012) 1/8W	D-±0.5%	+N: Lead-Free	
12-1206(3216) 1/4W	B-±0.1%	Special	
13-1210(3226) 1/3w		L : 06 – 2mm pitch	
20-2010(5025) 1/2W		paper Tape	
25-2512(6432) 1 W			

4. Dimensions:

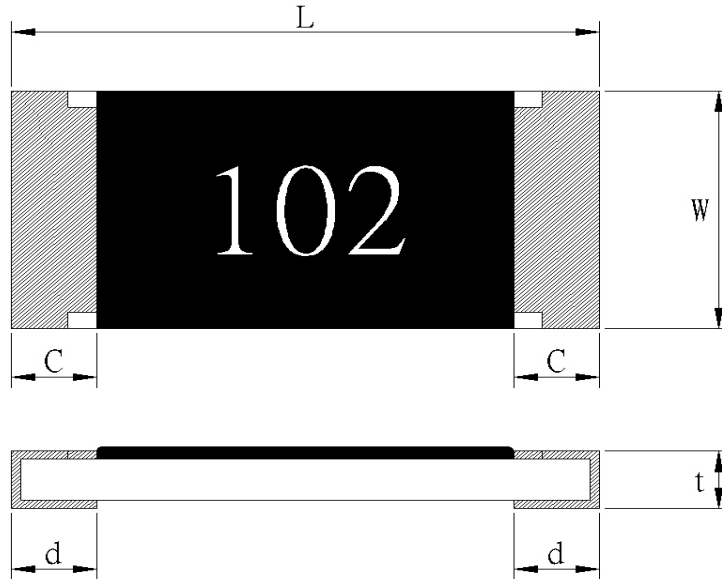

UNIT: mm

Type	L	W	C	d	t
RM02	0.60±0.03	0.30±0.03	0.1±0.05	0.15±0.05	0.25±0.05
RM04	1.00 ^{+0.1} _{-0.05}	0.50±0.05	0.20±0.10	0.25±0.10	0.35±0.05
RM06	1.60±0.10	0.80±0.10	0.30±0.20	0.30 ^{+0.2} _{-0.1}	0.45±0.10
RM10	2.00±0.10	1.25±0.10	0.40±0.20	0.40±0.20	0.50±0.10
RM12	3.10±0.10	1.55±0.10	0.50±0.30	0.40±0.20	0.60±0.10
RM13	3.10±0.10	2.55±0.10	0.50±0.30	0.40±0.20	0.60±0.10
RM20	5.00±0.15	2.50±0.15	0.60±0.30	0.50±0.25	0.60±0.10
RM25	6.30±0.20	3.20±0.20	0.60±0.30	0.50±0.25	0.60±0.10

5. Ratings & Characteristics :

Type	Power Rating at 70°C	Rating Voltage	Max. Working Voltage	Max. Over- Load Voltage	T.C.R (PPM/°C)	Resistance Range(Ω)				
						B(±0.1%) E-96	D(±0.5%) E-96	F(±1%) E-96	G(±2%) E-24	J(±5%) E-24
RM02	1/20W	Refer 5.2	25V	50V	±200			10Ω-1MΩ	10Ω-1MΩ	10Ω-10MΩ
RM04	1/16W	Refer 5.2	50V	100V	±200	10Ω-200kΩ	10Ω-1MΩ	10Ω-10MΩ	10Ω-10MΩ	10Ω-10MΩ
					+500 -200			1Ω-9.1Ω	1Ω-9.1Ω	1-9.1Ω
RM06	1/10W	Refer 5.2	50V	100V	±100	10Ω-560kΩ	10Ω-1MΩ	10Ω-1MΩ		
					±200			1M<R≤10MΩ	10Ω-10MΩ	10Ω-10MΩ
					±400			1Ω-9.1Ω	1Ω-9.1Ω	10Ω-10MΩ 1-9.1Ω 10M<R≤20MΩ
RM10	1/8W	Refer 5.2	150V	300V	±100	10Ω-560kΩ	10Ω-1MΩ	10Ω-1MΩ		
					±200			1M<R≤10MΩ	10Ω-10MΩ	10Ω-10MΩ
					±400			1Ω-9.1Ω	1Ω-9.1Ω	1-9.1Ω 10M<R≤20MΩ
RM12	1/4W	Refer 5.2	200V	400V	±100	10Ω-560kΩ	10Ω-1MΩ	10Ω-1MΩ		
					±200			1M<R≤10MΩ	10Ω-10MΩ	10Ω-10MΩ
					±400			1Ω-9.1Ω	1Ω-9.1Ω	1-9.1Ω 10M<R≤20MΩ
RM13	1/3W	Refer 5.2	200V	400V	±100	10Ω-560kΩ	10Ω-1MΩ	10Ω-1MΩ		
					±200			1M<R≤10MΩ	10Ω-10MΩ	10Ω-10MΩ
					±400			1Ω-9.1Ω	1Ω-9.1Ω	1-9.1Ω 10M<R≤20MΩ
RM20	1/2W	Refer 5.2	200V	400V	±100	10Ω-560kΩ	10Ω-1MΩ	10Ω-1MΩ		
					±200			1M<R≤10MΩ	10Ω-10MΩ	10Ω-10MΩ
					±400			1Ω-9.1Ω	1Ω-9.1Ω	1-9.1Ω 10M<R≤20MΩ
RM25	1W	Refer 5.2	200V	400V	±100	10Ω-560kΩ	10Ω-1MΩ	10Ω-1MΩ		
					±200			1M<R≤10MΩ	10Ω-10MΩ	10Ω-10MΩ
					±400			1Ω-9.1Ω	1Ω-9.1Ω	1-9.1Ω 10M<R≤20MΩ

O Ω THICK FILM CHIP RESISTORS

Type	Rated Current	Max Overload Current	Resistance Range
RM02	0.5A	1A	50mΩ MAX
RM04	1A	2.5A	50mΩ MAX
RM06	1A	2.5A	50mΩ MAX
RM10	2A	5A	50mΩ MAX
RM12	2A	5A	50mΩ MAX
RM13	2A	5A	50mΩ MAX
RM20	2A	5A	50mΩ MAX
RM25	2A	5A	50mΩ MAX

2. Operating Temp(°C) : -55°C ~ +125°C

Note : Except for the above standardized products, we also provide the customized products.

5.1 Derating Curve :

For resistors operated at ambient temperature over 70°C , power rating shall be derated in accordance with figure 1.

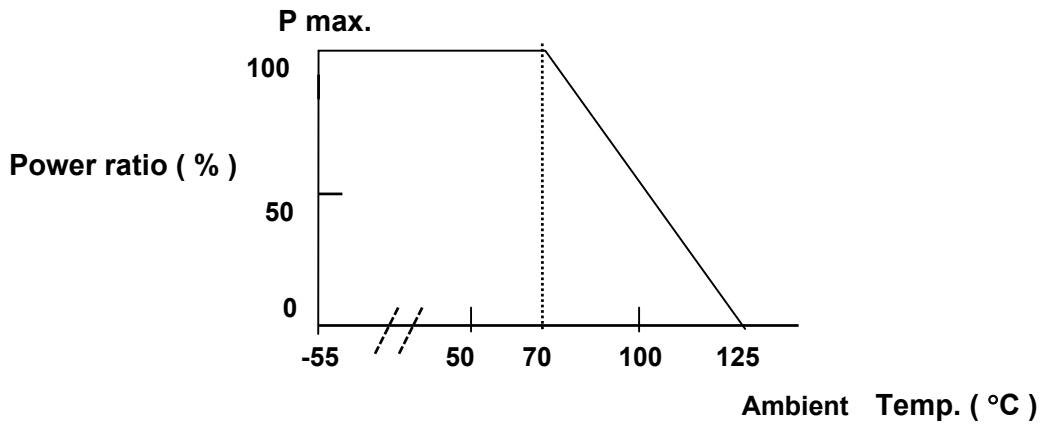

Figure 1

5.2 Rated Voltage:

The rated voltage is calculated by the following formula:

$$E = \sqrt{P * R}$$

E=Rated Voltage(V)

P=Rated Power(W)

R=Resistance Value(Ω)

E.G. : What is RM06JTN102 the rated voltage ?

RM06JTN102 P:1/10W ; R:102 = 1K Ω = 1000 Ω

$$E = \sqrt{0.1(W) * 1000(\Omega)} = 10 (V)$$

TA-I	Thick Film Chip Resistors	No	TRM-XX0S001J
	(Lead – Free for RM series standard)	page	5/13

6. Reliability Tests: (As specified in JIS C 5202)

Test Items	Reference standard	Condition of Test	Test Limits
Temperature Coefficient of Resistance	JIS-C5202-5.2	+25~ +125 °C	Refer 5.0
Short Time Overload	JIS-C5202-5.5	2.5 X rated voltage for 5 sec	±(1% + 0.05 Ω) Remarks : 0201 : ±(3% + 0.1 Ω) 0402 : ±(2% + 0.1 Ω) 0 Ω : 50mΩ or less
Intermittent Overload	JIS-C5202-5.8	3.0 X rated voltage or Max Overloading voltage , 1sec "ON" , 25sec "OFF" , 10000 cycles (Remarks : 0201 / 0402 2.5 X RCWV *)	± (5.0% + 0.1 Ω) 0 Ω : 50mΩ or less
Load Life	JIS-C5202-7.10	1000 hours at rated voltage , 70°C , 1.5hours "ON" , 0.5hour "OFF"	0.5%, 1%: ±(1.0%+0.05 Ω) 2%, 5%: ±(3.0%+0.1 Ω) Remarks : 0201 : ±(5.0%+0.1 Ω) 0402 : ±(3.0%+0.1 Ω) 0 Ω : 100mΩ or less
Load Life with Humidity	JIS-C5202-7.9	1000 hours at rated voltage , 40±2°C , 90~95% RH 1.5hours "ON" , 0.5hour "OFF"	0.5%, 1%: ±(1.0%+0.05 Ω) 2%, 5%: ±(3.0%+0.1 Ω) Remarks : 0201: ±(5.0%+0.1 Ω) 0402: ±(3.0%+0.1 Ω) 0 Ω : 100mΩ or less Without mechanical damage
Rapid Change of Temperature	JIS-C5202-7.4	-55°C (30 min.) / +155 °C (30 min.) 5 cycles	0.5%, 1%: ±(0.5%+0.05 Ω) 2%, 5%: ±(1.0%+0.05 Ω) Remarks : 0201: ±(3.0%+0.1 Ω) 0 Ω : 50mΩ or less
Solderability	JIS-C5202-6.11	245±5°C solder, 2±0.5 sec dwell. Solder : Sn96.5 / Ag3.0 / Cu0.5	At least 95% of surface area of electrode shall be covered with new solder.
Robustness of Termination (Bending)	JIS-C5202—6.1	3mm deflection	0.5%, 1%: ±(0.5%+0.05 Ω) 2%, 5%: ±(1.0%+0.05 Ω) Remarks : 0201 ±(1.0%+0.1 Ω) 0 Ω : 50mΩ or less
Dielectric Withstanding Voltage (Voltage Proof)	JIS-C5202-5.7	Applying voltage : 0201 : 50V , 0402 & 0603 : 300V The other 500V for a minute .	No abnormalities such as flashover, burning dielectric breakdown shall appear.
Insulation Resistance	JIS-C5202-5.6	Applying voltage 100V for 1 minute. Remark : 0201 50V	≥ 1GΩ
Resistance to Dry Heat	JIS-C5202-7.2	125±5°C for 96±4Hrs	0.5%, 1%: ±(1.0%+0.05 Ω) 2%, 5%: ±(2.0%+0.1 Ω) Remark 0201 : ±(2.0%+0.1 Ω) 0 Ω : 50mΩ or less
Resistance to Solder Heat	JIS-C5202-6.10	270 ±5°C solder , 10 ±1 sec dwell .	0.5%, 1%: ±(0.5%+0.05 Ω) 2%, 5%: ±(1.0%+0.05 Ω) Remarks : 0201 ±(3.0%+0.1 Ω) 0 Ω : 50mΩ or less

TA-I	Thick Film Chip Resistors	No	TRM-XX0S001J
	(Lead – Free for RM series standard)	page	6/13

Whisker	SONY SS-00254-8	<p>Component , Lead-Free Soldering part 8 : Solder Heat Resistance Test for SMD. Lead-Free Soldering “</p> <p>Temp. Cycles : -35 ± 5°C / 125 ± 5°C , Keep 7 min Testing duration : 500±4 hours</p> <p>Temp. Humidity Chambers: Temperature : 85°C Humidity : 85% RH Testing duration : 500±4 hours .</p>	Whisker formation : 50 um or less .
Resistance to Solder Heat	SONY SS-00254-5	<p>Component , Lead-Free Soldering part 5 : Solder Heat Resistance Test for SMD. Lead-Free Soldering “</p> <p>Flow Solder : Pre – heat : 100 to 105 °C 30±5 sec Temperature : 260±3°C 10 +1/- 0 sec The entire sample shall be dipped in solder. The specimen shall be stored at standard atmospheric conditions for 1 hour .</p> <p>Iron Solder : Bit temperature : 350 ±10°C Application time of soldering iron : 3 +1/- 0sec Apply the soldering iron to the electrode . The specimen shall be stored at standard atmospheric conditions for 1 hour , after which the measurements shall be made</p>	Electrical characteristics shall be Satisfied . Without distinct deformation in appearance

Note* : RCWV : Rated continuous working voltage .

7. Marking

7.1 ±2% & ±5%(E24)

Resistance value is expressed by 3 digits, the first two digits represent the significant figures of nominal resistance value in Ω , and the third digit represents exponent for base of 10.

E.G. :, 472 = $47 \times 10^2 = 4700 \Omega = 4.7K \Omega$

7.2 ±1% (E96)

Resistance value is expressed by 4 digits or 3digits , the first three digits represent the significant figures of nominal resistance value in Ω , and the fourth digit represents exponent for base of 10.

E.G. : 4701 = $470 \times 10^1 = 4700 \Omega = 4.7K$

7.3 ±1%(RM06/E96)

When the marking space is too small in such small-sized resistors as RM06, the marking can not be made by 4 digits and may be made by two digits combined with one English capital.

Symbol for E96 series nominal resistance value

Symbol	E96	Symbol	E96	Symbol	E96	Symbol	E96
01	100	25	178	49	316	73	562
02	102	26	182	50	324	74	576
03	105	27	187	51	332	75	590
04	107	28	191	52	340	76	604
05	110	29	196	53	348	77	619
06	113	30	200	54	357	78	634
07	115	31	205	55	365	79	649
08	118	32	210	56	374	80	665
09	121	33	215	57	383	81	681
10	124	34	221	58	392	82	698
11	127	35	226	59	402	83	715
12	130	36	232	60	412	84	732
13	133	37	237	61	422	85	750
14	137	38	243	62	432	86	768
15	140	39	249	63	442	87	787
16	143	40	255	64	453	88	806
17	147	41	261	65	464	89	825
18	150	42	267	66	475	90	845
19	154	43	274	67	487	91	866
20	158	44	280	68	499	92	887
21	162	45	287	69	511	93	909
22	165	46	294	70	523	94	931
23	169	47	301	71	536	95	953
24	174	48	309	72	549	96	976

Symbol for multipliers

Symbol	A	B	C	D	E	F	G	H	X	Y	Z
multipliers	10 ⁰	10 ¹	10 ²	10 ³	10 ⁴	10 ⁵	10 ⁶	10 ⁷	10 ⁻¹	10 ⁻²	10 ⁻³

E.G : 02C = 102×10² = 10.2kΩ

Notes :

When the resistance value is not in the list of E96 , 3 digitals with underline in E-24 series is used as mark .

E.G.: 0603 , 120Ω , 1% Marking is 121

7.4 ±1%(E96/3digitals)

The resistance value by 3 digits is requirement for customer.

7.5 No Marking for RM04

8. Taping & Reel :

8.1 Taping Dimensions

8.1.1 4 mm pitch paper:

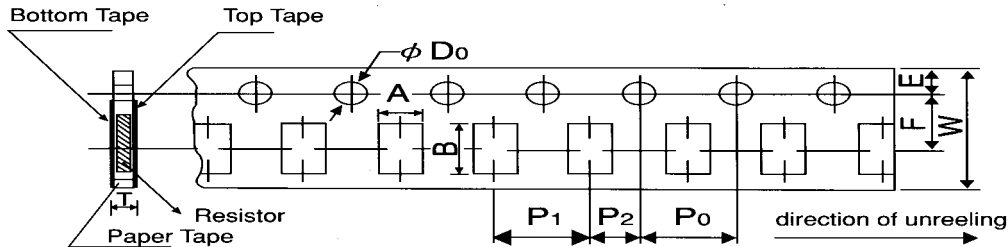

Packing	Type	A	B	W	F	E	P ₁	P ₂	P ₀	D ₀	T
Paper	RM06	1.1±0.1	1.9±0.1	8.0±0.2	3.5±0.05	1.75±0.1	4.0±0.1	2.0±0.05	4.0±0.1	φ 1.5 +0.1 -0	0.64±0.1
	RM10	1.6±0.15	2.4±0.2								0.84±0.1
	RM12	2.0±0.15	3.6±0.2								
	RM13	2.8±0.2	3.6±0.2								

8.1.2 2 mm pitch paper :

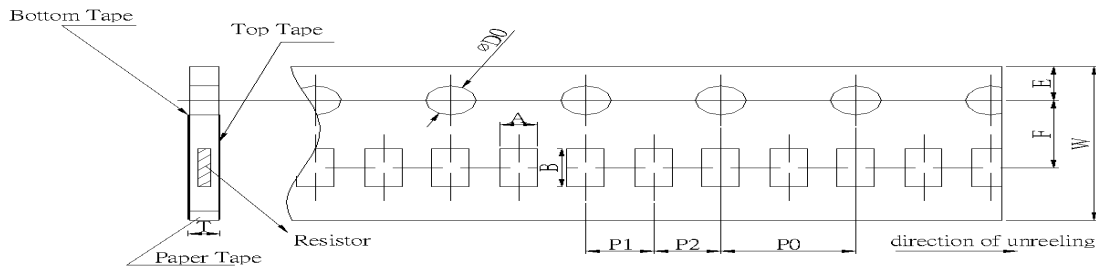

Packing	Type	A	B	W	F	E	P ₁	P ₂	P ₀	D ₀	T
Paper	RM02	0.37±0.05	0.67±0.1	8.0±0.2	3.5±0.05	1.75±0.1	2.0±0.1	2.0±0.05	4.0±0.1	φ 1.5 +0.1 -0	0.37±0.1
	RM04	0.7±0.05	1.2±0.05				2.0±0.1	2.0±0.1			0.45±0.1
	RM06	1.1±0.1	1.9±0.1				2.0±0.1	2.0±0.1			0.64±0.1

8.1.3 4 mm pitch Emboss :

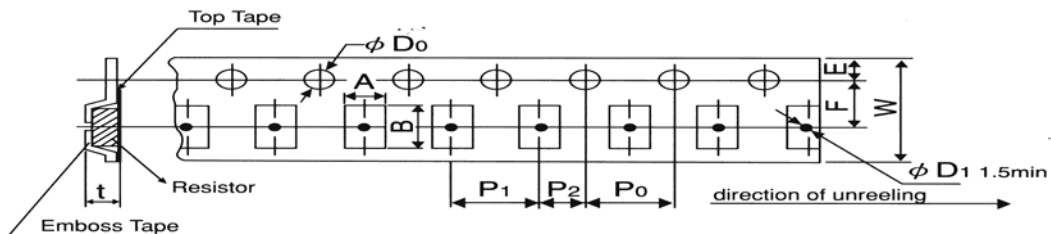

Packing	Type	A	B	W	F	E	P ₁	P ₂	P ₀	D ₀	T
Emboss	RM20	2.8±0.2	5.3±0.2	12.0±0.2	5.5±0.05	1.75±0.1	4.0±0.1	2.0±0.05	4.0±0.05	φ 1.5 +0.1 -0	0.85±0.15
	RM25	3.6±0.2	6.9±0.2								

8.14. Bulk Case Specifications:

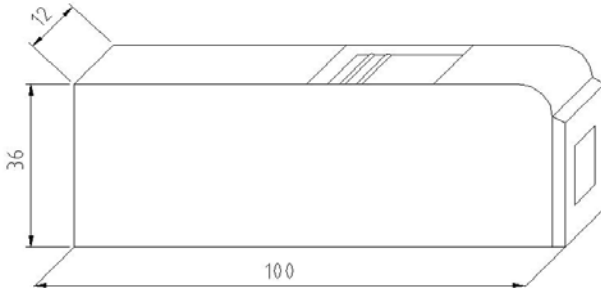

UNIT: mm

Package		Paper Tape				Emboss Plastic Tape 4 mm pitch	Bulk
		4 mm pitch		2 mm pitch			
		180mm/R	250mm/R	180mm/R	250mm/R		
Type	Size						
RM	02			10000			
RM	04			10000	20000		50000
RM	06	5000	10000	10000	20000		20000
RM	10	5000	10000				10000
RM	12	5000	10000				5000
RM	13	5000					
RM	20					4000	
RM	25					4000	

8.2 Reel Specifications:

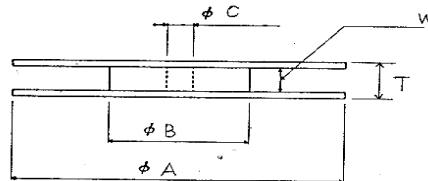
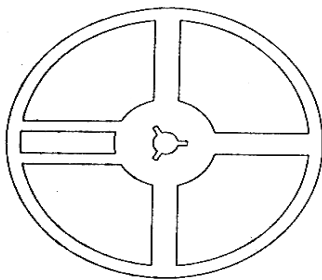

UNIT: mm

Type	ϕA	ϕB	ϕC	W	T
RM02 / 04 / 06 RM10 / 12 / 13	178.0 ± 1.0	60.0 ± 1.0	13.0 ± 1.0	9.0 ± 1.0	11.5 ± 1.0
RM20 / 25				13.0 ± 1.0	15.5 ± 1.0

8.3. Peel –off force :

Peel –off force of paper and blister tape is in accordance with “JIS-C5202 ” that is , 0.1 to 0.7 N at a peel-off speed of 300 mm / minute.

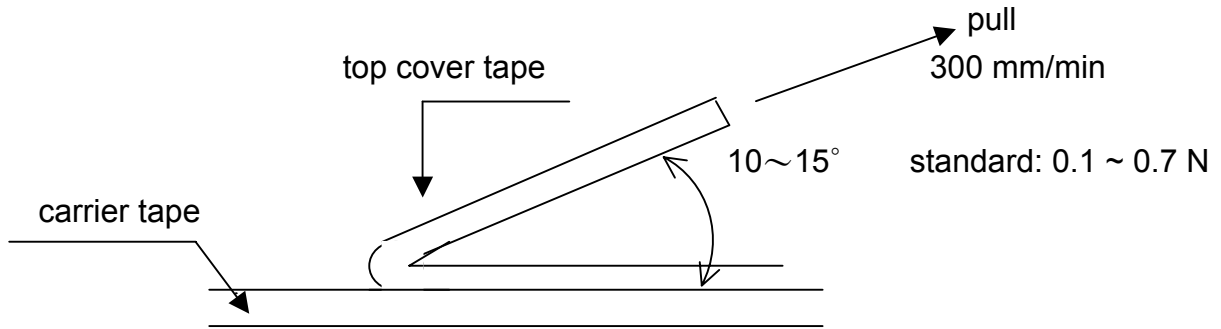

9. Label :

9.1 Manufacture Label :

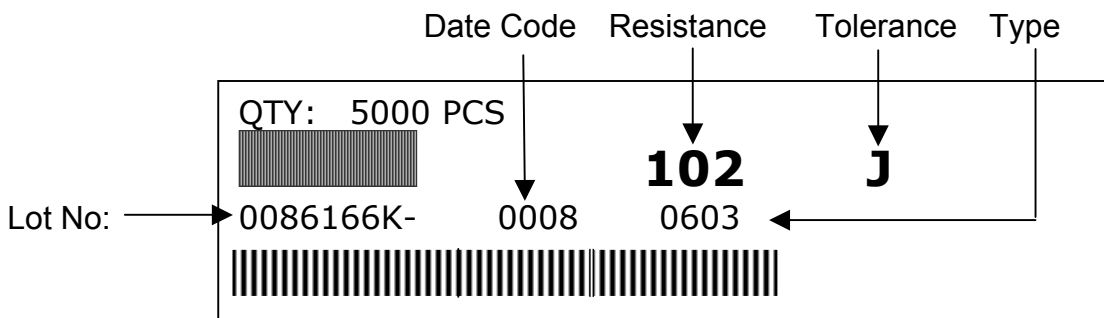

9.2 Customer Label:

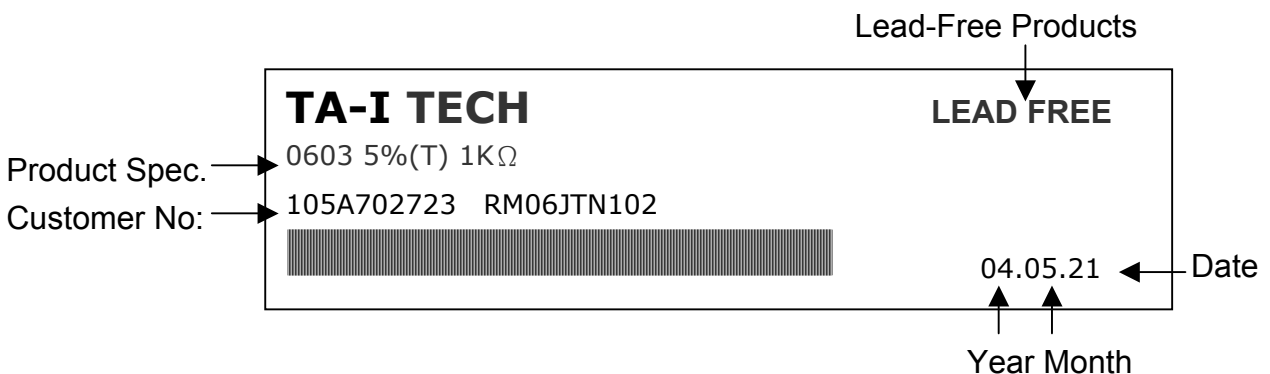

10. Recommended land patterns :

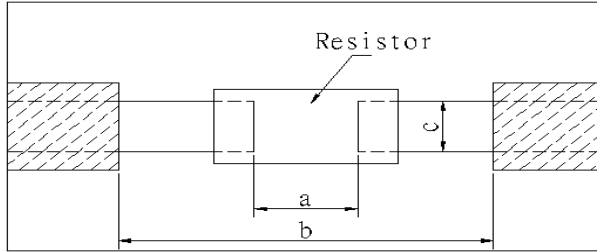

Type	Size	Land pattern			Dimension (mm)		
		a	b	c	a	b	c
RM	02 (0201)	0.25~0.3	0.7~0.9	0.3~0.4			
RM	04 (0402)	0.50~0.6	1.4~1.6	0.4~0.6			
RM	06 (0603)	0.7~0.9	2.0~2.2	0.8~1.0			
RM	10 (0805)	1.0~1.4	3.2~3.8	0.9~1.4			
RM	12 (1206)	2.0~2.4	4.4~5.0	1.2~1.8			
RM	13 (1210)	2.0~2.4	4.4~5.0	2.3~3.5			
RM	20 (2010)	3.3~3.7	5.7~6.5	2.3~3.5			
RM	25 (2512)	3.6~4.0	7.6~8.6	2.3~3.5			

11. Recommend IR – Reflow profile : (solder : Sn96.5 / Ag3 / Cu0.5)

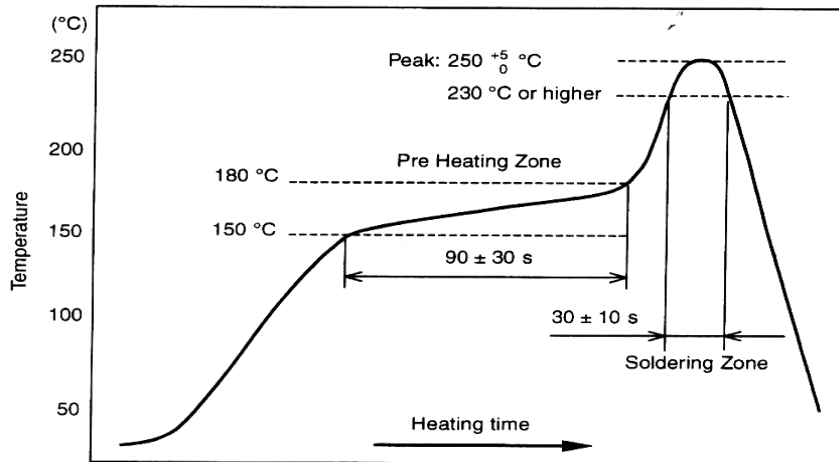

Peak : $250 \begin{matrix} +5 \\ -0 \end{matrix} \text{ } ^\circ\text{C}$, 5 sec

Pre – heat Zone : 150 to 180 °C, 90±30 sec

Soldering Zone : 230°C or higher , 30±10 sec

TA-I	Thick Film Chip Resistors (Lead – Free for RM series standard)	No	TRM-XX0S001J
		page	12/13

12. Storage Conditions:

Temperature: 5°C~35°C, Humidity:40%~75%

13. Shelf Life:

2 years from manufacturing date.

14. ECN :

Engineering Change Notice: The customer will be informed with ECN if there is significant modification on the characteristics and materials described in Approval Sheet.

15. Manufacturing Country & City :

TA-I TECHNOLOGY CO., LTD. (Taiwan– Tao Yuan)

Tel: 886-3-3246169 Fax : 886-3-3246167

Associated companies :

(1) FORTUNE TASK RESISTOR FACTORY (China – Dongguan)

Tel : 86-769-8339-4790~3 Fax : 86-769-8339-4794

(2) TA-I TECHNOLOGY (DONGGUAN) CO., LTD. (China –Dongguan)

Tel : 86-769-8339-4790~3 Fax : 86-769-8339-4794

(3) TA-I TECHNOLOGY (SU ZHOU) CO., LTD. (China – Su Zhou)

Tel :86- 512-63457879 Fax : 86-512-63457869

(4) TAI OHM ELECTRONICS (M) SDN. BHD. (Malaysia – Pulaupinang)

Tel :604- 3900480 Fax : 604-3901481

(5) P.T.TAI ELECTRONICS Indonesia (Indonesia – Jakarta)

Tel :002-62-21-44820254 Fax : 002-62-21-44820256

TA-I	Thick Film Chip Resistors	No	TRM-XX0S001J
	(Lead – Free for RM series standard)	page	13/13

Revise record

Date	Content	Owner
2005/11/25	4. Ratings & Characteristics : Adding Rating Voltage	Hank Liu
2005/12/12	6. Reliability Tests Short Time Overload : add 0402 & 0201 Intermittent Overload : add 0402 & 0201 Load Life : add 0402 & 0201 Load Life with Humidity : add 0402 & 0201 Rapid Change of Temperature: add 0402 & 0201 Robustness of Termination : add 0402 & 0201 Dielectric Withstanding Voltage (Voltage Proof) : add 0402 & 0201 Insulation Resistance : add 0402 & 0201 Resistance to Dry Heat : add 0402 & 0201 Resistance to Solder Heat : add 0402 & 0201	Hank Liu
2006/03/15	1. Adding resistance range for 1% 0603~2512 size from 1M Ω to 10 M Ω .	Vincent
2006/05/11	2. Adding resistance range for 1%,2% 0402 size from 1M Ω to 10 M Ω .	Vincent
2006/05/22	1. Adding metric system for product size. 2. Construction: Conductor: New add : Lead-free material (Original :With lead material)	Vincent
2006/06/09	2. Adding resistance range : 0402 size : Adding 0.1% : from 10 Ω to 200 K Ω . Adding 0.5% : from 10 Ω to 1 M Ω . 0603-2512 size : 0.1% , 0.5% : before :from 56 Ω to 560k Ω . after : from 10 Ω to 1 M Ω . Adding 5% :10M Ω to 20M Ω .	Vincent