

C-13-002-XX-SXXXX/XXX-X-XX

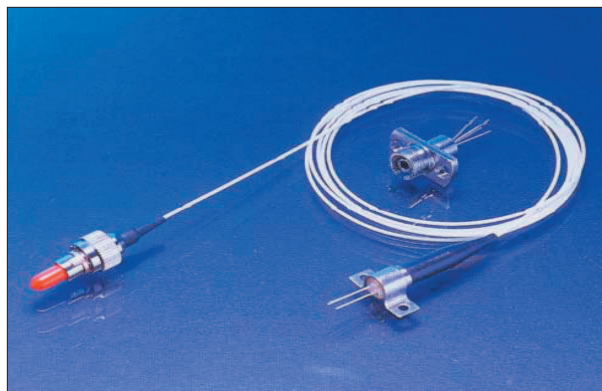

Features

- Laser diode with multi-quantum-well structure
- Un-cooled operation at -40~+85°C
- High temperature operation without active cooling
- Built-in InGaAs monitor photodiode
- Hermetically sealed active component
- Complies with Telcordia Technologies GR-468-CORE
- TOSA
- FC/ST/SC receptacle package with 2-hole flange
- Fiber pigtailed with optional FC/ST/SC/MU/LC connector
- Design for 2.5G high speed optic networks
- RoHS Compliant available

Absolute Maximum Ratings (Tc=25°C)

Parameter	Symbol	Rating	Unit
Fiber Output Power L/M/H/2	P_f	1(L) / 1.5(M) / 2.5(H) / 3(2)	mW
Reverse Voltage	V_{RLD}	2	V
PD Reverse Voltage	V_{RPD}	10	V
PD Forward Current	I_{FPD}	2.0	mA
Operating Temperature	T_{opr}	-40 ~ +85	°C
Storage Temperature	T_{stg}	-40 ~ +85	°C
Soldering Temperature (<10sec)	Stamp	260	°C

(All optical data refer to a coupled 9/125µm SM fiber)

Optical and Electrical Characteristics (Tc=25°C)

Parameter	Symbol	Min	Typ	Max	Unit	Test Conditions
Threshold Current	I_{th}	-	10	15	mA	CW
Fiber Output Power	P_f	0.2 0.5 1 2	- - 1.6 2.5	0.5 1.0 - -	mW	CW, $I_{th}+20mA$, kink free
Peak Wavelength	λ	1290	1310	1330	nm	CW, $P_f = P_f$ (Min)
Spectrum Width (RMS)	$\Delta \lambda$	-	2	5	nm	CW, $P_f = P_f$ (Min)
Forward Voltage	V_f	-	1.2	1.5	V	CW, $P_f = P_f$ (Min)
Rise Time/Fall Time	t_r / t_f	-	-	150	ps	$I_{bias} = I_{th}$, 10~90%
Tracking Error	$\Delta P / P_f$	-1.5	-	1.5	dB	APC, -40~+85°C
PD Monitor Current	I_m	100	-	-	µA	CW, $P_f = P_f$ (Min), $V_{RPD}=2V$
PD Dark Current	I_{dark}	-	-	0.1	µA	$V_{RPD}=5V$
PD Capacitance	C_t	-	6	15	pF	$V_{RPD}=5V$, $f=1MHz$

- Note:**
- 1.Pin assignment can be customized.
 - 2.Specifications subject to change without notice.

C-13-002-XX-SXXXX/XXX-X-XX

LD Pin Assignment

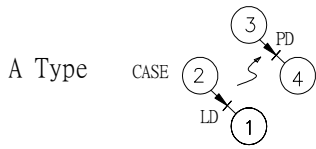

A Type
 Pin 1 : Laser Cathode
 Pin 2 : Laser Anode and Case Gnd
 Pin 3 : Monitor Diode Anode
 Pin 4 : Monitor Diode Cathode

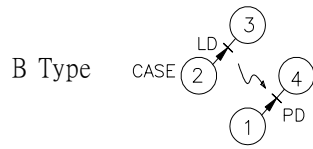

B Type
 Pin 1 : Monitor Diode Anode
 Pin 2 : Laser Anode and Case Gnd
 Pin 3 : Laser Cathode
 Pin 4 : Monitor Diode Cathode

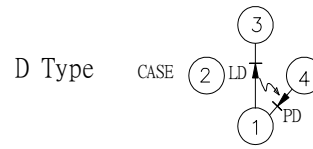

D Type
 Pin 1 : Laser Anode and Monitor Diode Cathode
 Pin 2 : Case Gnd
 Pin 3 : Laser Cathode
 Pin 4 : Monitor Diode Anode

Packaging Dimension

Units in mm.

Part Number: C-13-002-RX-SXXXX-XX

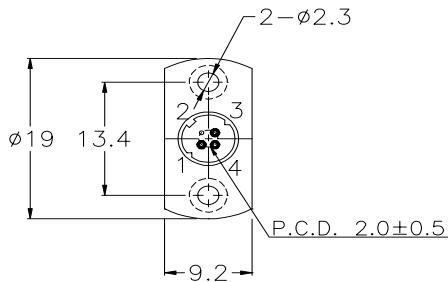

FC Receptacle

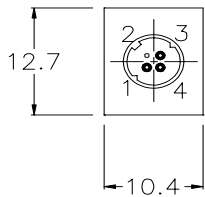
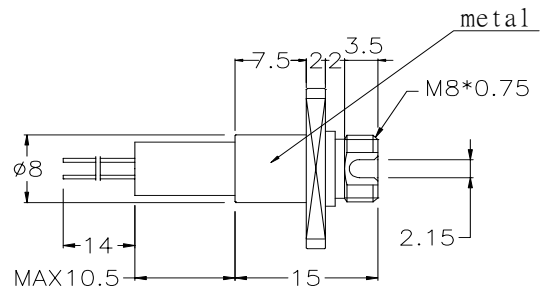

ST Receptacle

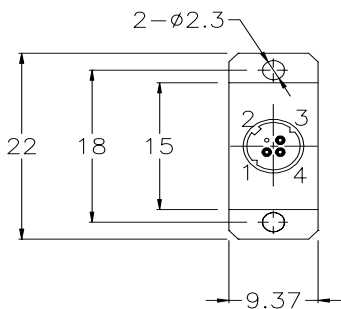
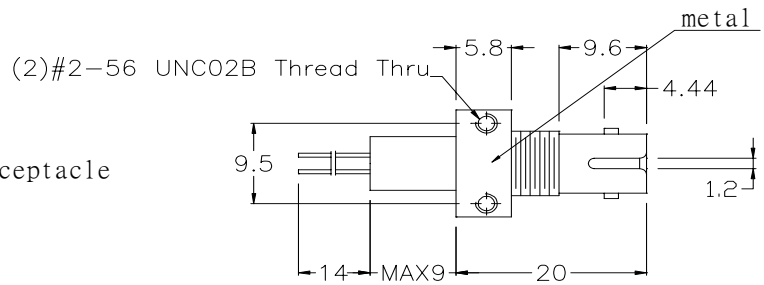

SC Receptacle

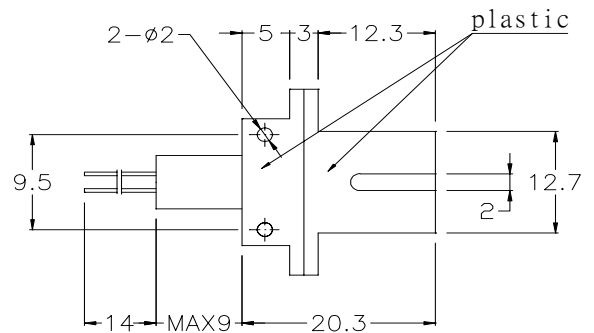

C-13-002-XX-SXXXX/XXX-X-XX

Packaging Dimension

Units in mm.

Part Number: C-13-002-TX-SSCXX-XX

P.C.D. 2.0 ± 0.5

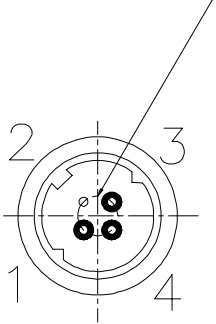

SC TOSA (L&M Power)
C-13-002-TX-SSCX-XX

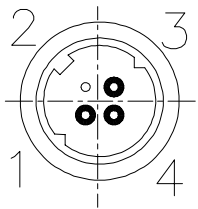
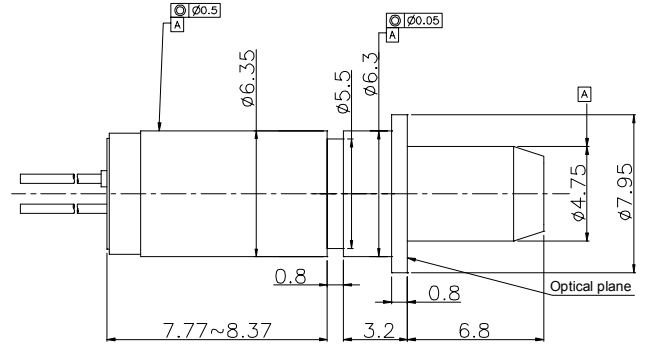

SC TOSA (L&M Power with Isolator)
C-13-002-TX-SSCXI-XX

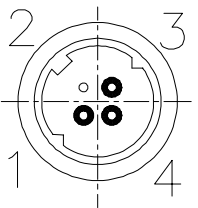
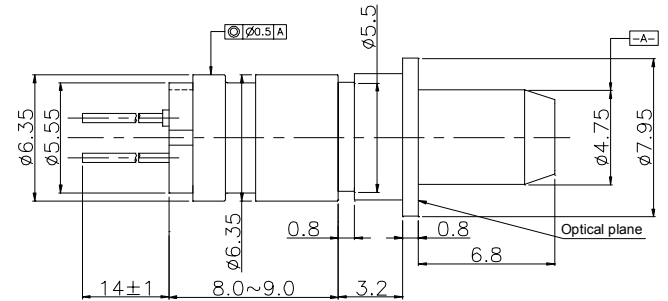

SC TOSA (H&2 Power)
C-13-002-TX-SSCXX-XX

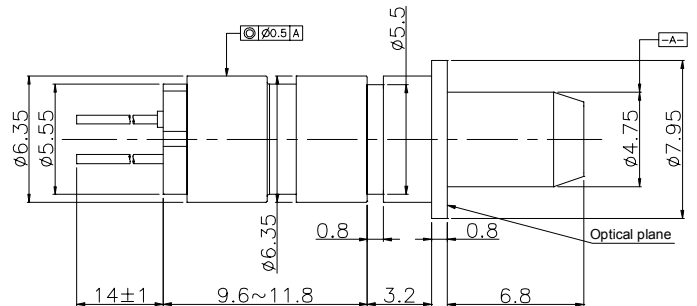

C-13-002-XX-SXXXX/XXX-X-XX

Packaging Dimension

Units in mm.

Part Number: C-13-002-TX-SLCXX-XX

P.C.D. 2.0 ± 0.5

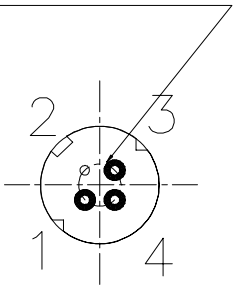

LC TOSA (L&M Power)
C-13-002-TX-SLCX-XX

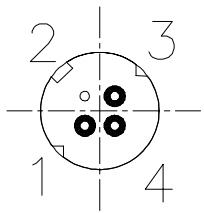
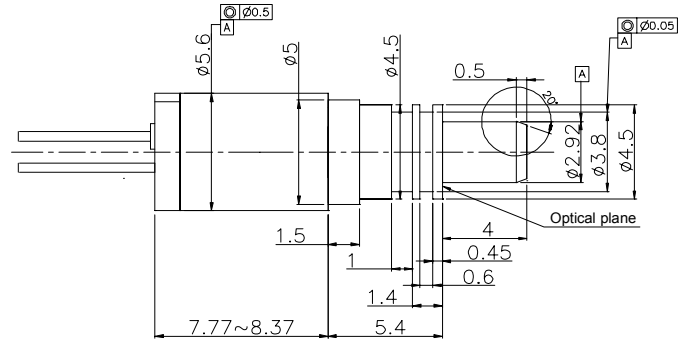

LC TOSA (L&M Power with Isolator)
C-13-002-TX-SLCXI-XX

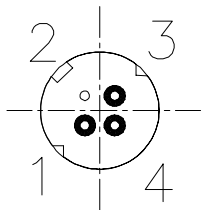
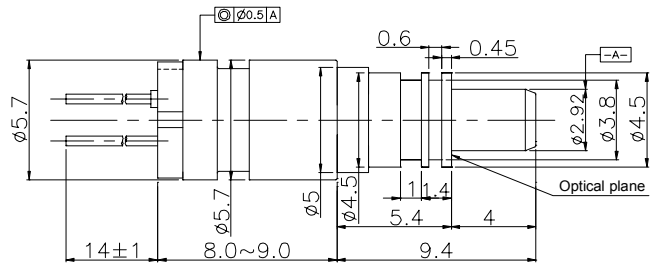

LC TOSA (H&2 Power)
C-13-002-TX-SLCXX-XX

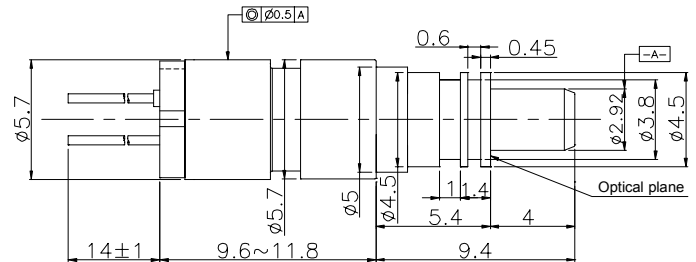

Packaging Dimension

Units in mm.

Part Number: C-13-002-TX-SMUXX-XX

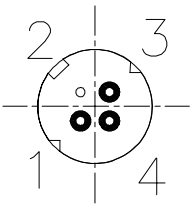

MU TOSA (L&M Power)
C-13-002-TX-SMUXX-XX

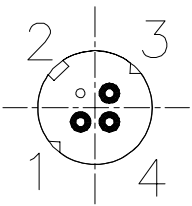
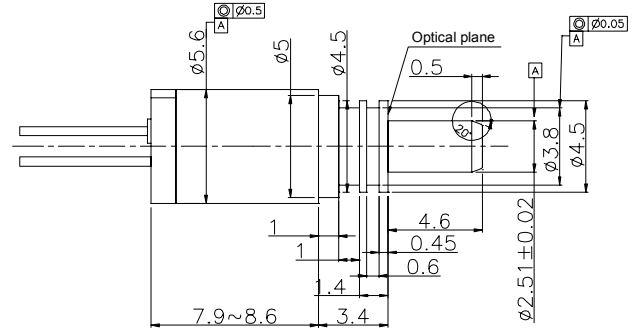

MU TOSA (L&M Power with Isolator)
C-13-002-TX-SMUXX-XX

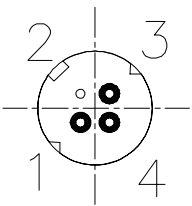
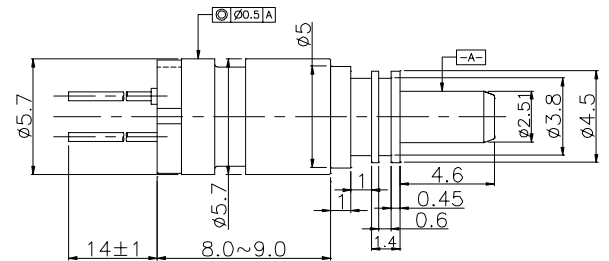

MU TOSA (H&2 Power)
C-13-002-TX-SMUXX-XX

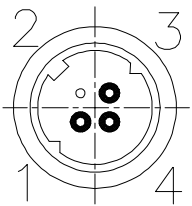
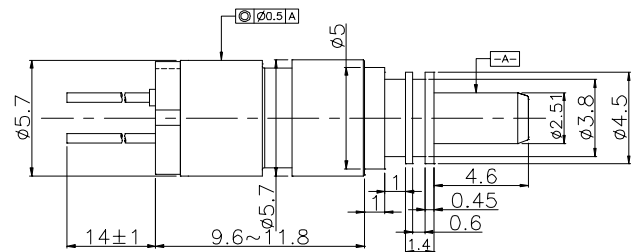

Customer Specified
TOSA

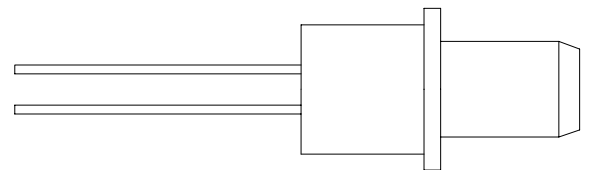

Packaging Dimension

Units in mm.

Part Number: C-13-002-PX-SXXXX/XXX-X-XX

P.C.D. 2.0 ± 0.5

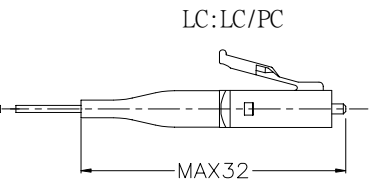
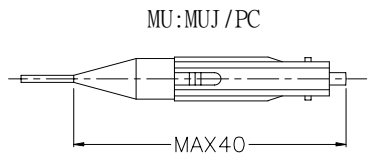
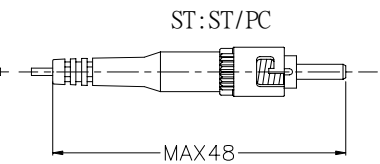
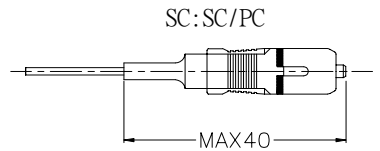
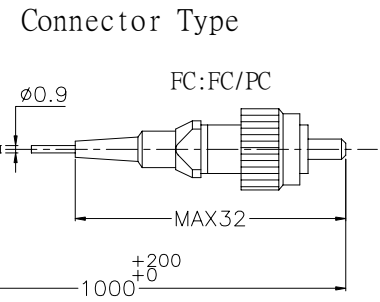
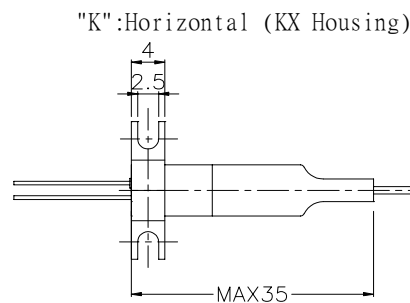
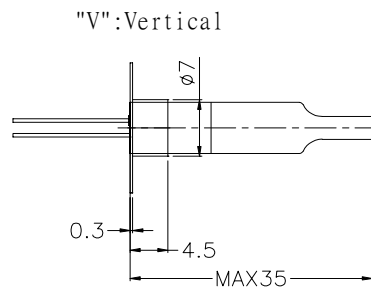
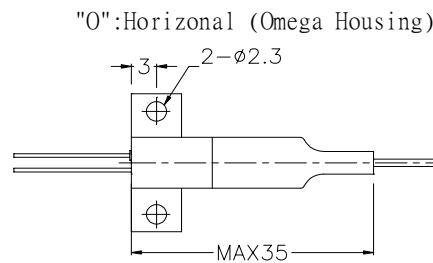
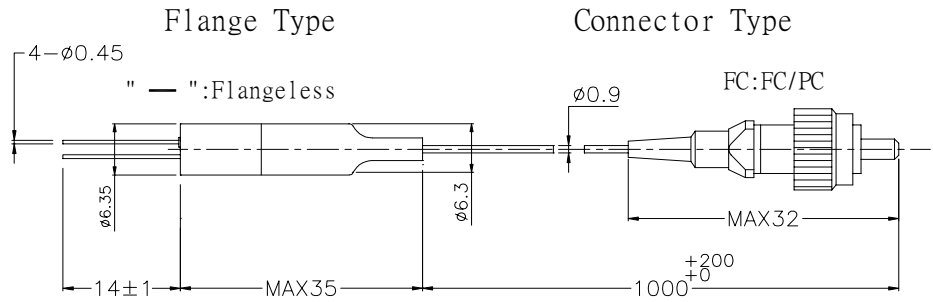
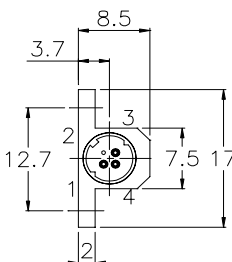
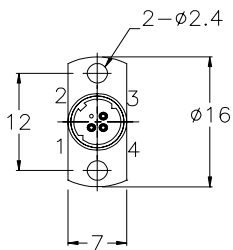
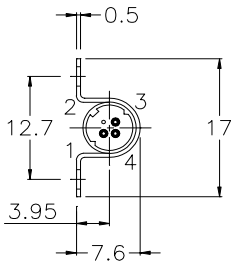
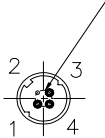

Ordering Information

C-13-002-XX-SXXXXX/XXX-X-XX

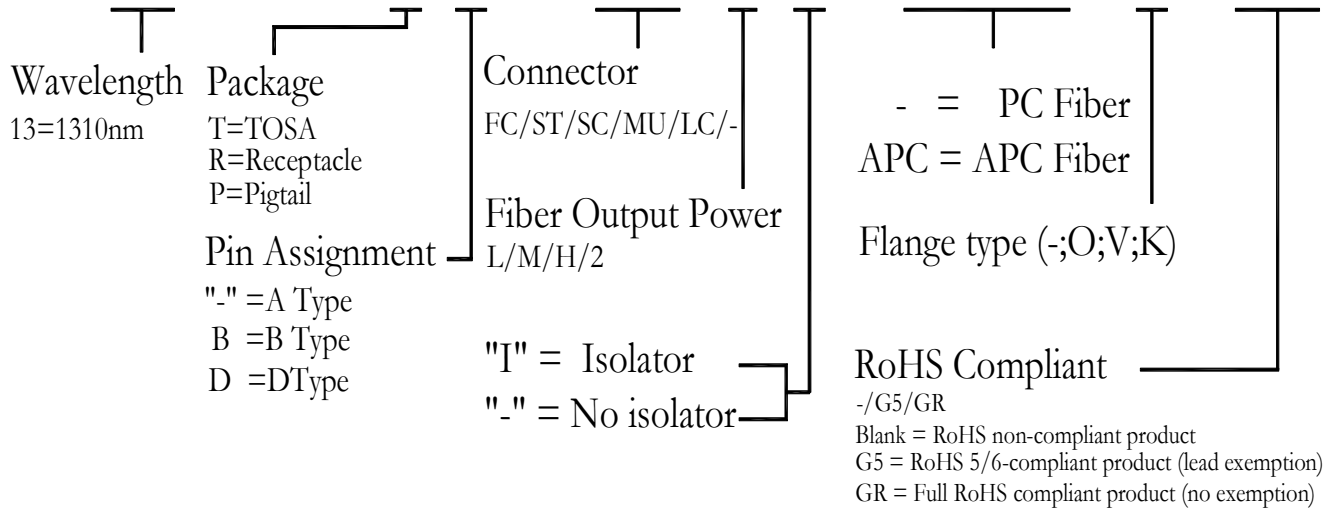

Warnings

Handling Precautions: This device is susceptible to damage as a result of electrostatic discharge (ESD). A static free environment is highly recommended. Follow guidelines according to proper ESD procedures.
 Laser Safety: Radiation emitted by laser devices can be dangerous to human eyes. Avoid eye exposure to direct or indirect radiation.

Legal Notice

IMPORTANT NOTICE!
 All information contained in this document is subject to change without notice, at Luminent's sole and absolute discretion. Luminent warrants performance of its products to current specifications only in accordance with the company's standard one-year warranty; however, specifications designated as "preliminary" are given to describe components only, and Luminent expressly disclaims any and all warranties for said products, including express, implied, and statutory warranties, warranties of merchantability, fitness for a particular purpose, and non-infringement of proprietary rights. Please refer to the company's Terms and Conditions of Sale for further warranty information.

Luminent assumes no liability for applications assistance, customer product design, software performance, or infringement of patents, services, or intellectual property described herein. No license, either express or implied, is granted under any patent right, copyright, or intellectual property right, and Luminent makes no representations or warranties that the product(s) described herein are free from patent, copyright, or intellectual property rights. Products described in this document are NOT intended for use in implantation or other life support applications where malfunction may result in injury or death to persons. Luminent customers using or selling products for use in such applications do so at their own risk and agree to fully defend and indemnify Luminent for any damages resulting from such use or sale.

THE INFORMATION CONTAINED IN THIS DOCUMENT IS PROVIDED ON AN "AS IS" BASIS. Customer agrees that Luminent is not liable for any actual, consequential, exemplary, or other damages arising directly or indirectly from any use of the information contained in this document. Customer must contact Luminent to obtain the latest version of this publication to verify, before placing any order, that the information contained herein is current.

© Luminent, Inc. 2006