

JDV CONNECTOR

1.5mm pitch/Hinge type Board-to-board Connectors

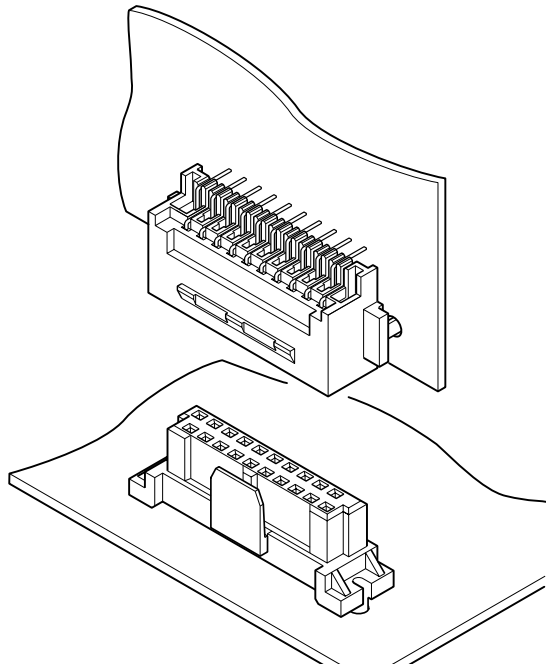

The JDV connector is designed for board-to-board connection with locking device, and highly resistant to equipment vibration and shock.

- Two type Locking device
- Staggered Solder Tails
- Positioning boss (projection)

Specifications

- Current rating: 1.0A AC, DC
- Voltage rating: 50V AC, DC
- Temperature range: -25°C to +85°C
(including temperature rise in applying electrical current)
- Contact resistance: Initial value/30m Ω max.
After environmental testing/50m Ω max.
- Insulation resistance: 800M Ω min.
- Withstanding voltage: 300V AC/minute
- Applicable PC board thickness: 1.6mm
- * Compliant with RoHS.
- * Refer to "General Instruction and Notice when using Terminals and Connectors" at the end of this catalog.
- * Contact JST for details.

Standards

Recognized E60389

Certified LR20812

PC board layout (viewed from component side) and Assembly layout

Plug

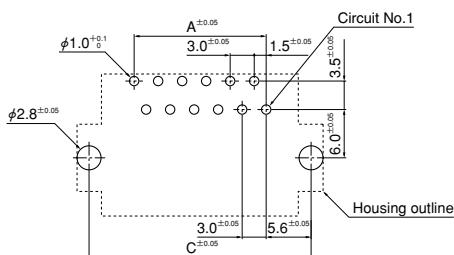

Receptacle

Resin hook type

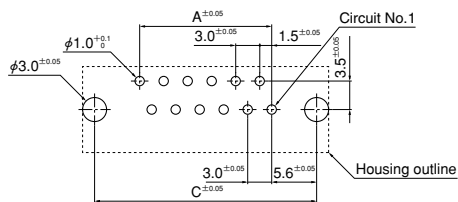

Metal hook type

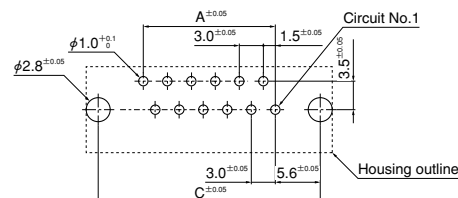

Note: 1. Tolerances are non-cumulative: $\pm 0.05\text{mm}$ for all centers.

2. Hole dimensions differ according to the kind of PC board and piercing method. The dimensions above should serve as a guideline. Contact JST for details.

JDV CONNECTOR

Plug

Retention lock type Resin hook type

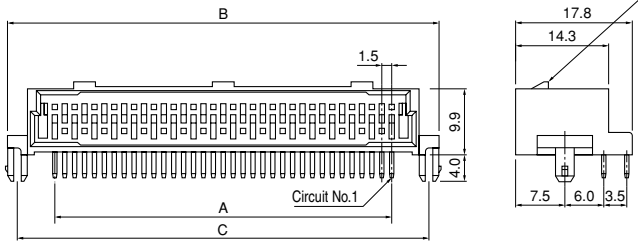

Metal hook type

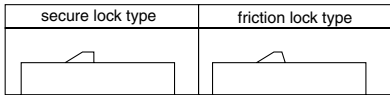
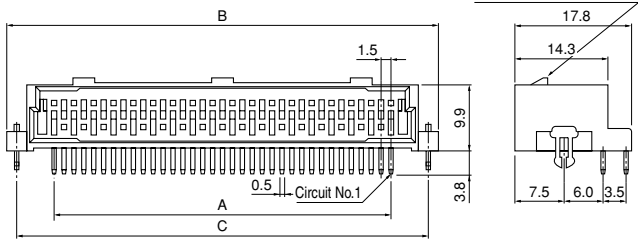

Resin hook type

Circuits	Model No.		Dimensions (mm)			Qty / box
	secure lock type	friction lock type	A	B	C	
15	JDV-PS15LB-10-1	—	21.0	35.5	32.2	400
20	JDV-PS20LB-10-1	JDV-PS20FLB-10-1	28.5	43.0	39.7	320
25	JDV-PS25LB-10-1	JDV-PS25FLB-10-1	36.0	50.5	47.2	280
30	JDV-PS30LB-10-1	JDV-PS30FLB-10-1	43.5	58.0	54.7	240
35	JDV-PS35LB-10-1	JDV-PS35FLB-10-1	51.0	65.5	62.2	200
40	JDV-PS40LB-10-1	JDV-PS40FLB-10-1	58.5	73.0	69.7	160
50	JDV-PS50LB-10-1	JDV-PS50FLB-10-1	73.5	88.0	84.7	160

Material and Finish

Contact: Brass, nickel-undercoated, Mating part; gold-plated
Solder tail; tin-plated (reflow treatment)
Housing: Glass-filled PBT, UL94V-0

RoHS compliance This product displays (LF)(SN) on a label.

Metal hook type

Circuits	Model No.		Dimensions (mm)			Qty / box
	secure lock type	friction lock type	A	B	C	
20	JDV-PS20LB-10A	—	28.5	43.0	39.7	320
25	JDV-PS25LB-10A	—	36.0	50.5	47.2	280
30	JDV-PS30LB-10A	JDV-PS30FLB-10A	43.5	58.0	54.7	240
35	JDV-PS35LB-10A	JDV-PS35FLB-10A	51.0	65.5	62.2	200
40	JDV-PS40LB-10A	—	58.5	73.0	69.7	160
50	JDV-PS50LB-10A	JDV-PS50FLB-10A	73.5	88.0	84.7	160
65	—	JDV-PS65FLB-10A	96.0	110.5	107.2	120

Material and Finish

Contact: Brass, nickel-undercoated, Mating part; gold-plated
Solder tail; tin-plated (reflow treatment)
Housing: Glass-filled PBT, UL94V-0
Reinforcing pin: Brass, copper-undercoated, tin-plated (reflow treatment)

RoHS compliance This product displays (LF)(SN) on a label.

Receptacle

Retention lock type Resin hook type

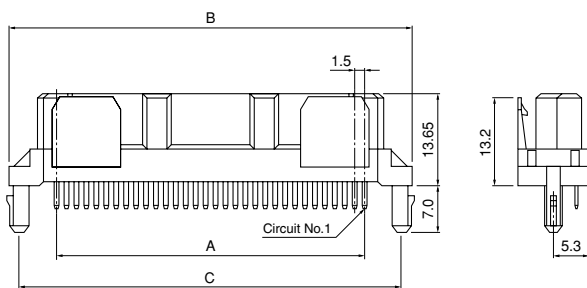

Metal hook type

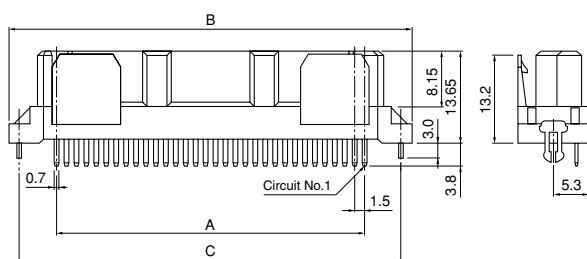

Resin hook type

Circuits	Model No.	Dimensions (mm)			Qty / box
		A	B	C	
15	JDV-R15LB-10-1	21.0	35.5	32.2	500
20	JDV-R20LB-10-1	28.5	43.0	39.7	400
25	JDV-R25LB-10-1	36.0	50.5	47.2	350
30	JDV-R30LB-10-1	43.5	58.0	54.7	300
35	JDV-R35LB-10-1	51.0	65.5	62.2	250
40	JDV-R40LB-10-1	58.5	73.0	69.7	200
50	JDV-R50LB-10-1	73.5	88.0	84.7	200

Material and Finish

Contact: Phosphor bronze, nickel-undercoated,
Mating part; gold-plated
Solder tail; tin-plated (reflow treatment)
Housing: Glass-filled PBT, UL94V-0

RoHS compliance This product displays (LF)(SN) on a label.

Metal hook type

Circuits	Model No.	Dimensions (mm)			Qty / box
		A	B	C	
20	JDV-R20LB-10A	28.5	43.0	39.7	400
25	JDV-R25LB-10A	36.0	50.5	47.2	350
30	JDV-R30LB-10A	43.5	58.0	54.7	300
35	JDV-R35LB-10A	51.0	65.5	62.2	250
40	JDV-R40LB-10A	58.5	73.0	69.7	200
50	JDV-R50LB-10A	73.5	88.0	84.7	200
65	JDV-R65LB-10A	96.0	110.5	107.2	150

Material and Finish

Contact: Phosphor bronze, nickel-undercoated,
Mating part; gold-plated
Solder tail; tin-plated (reflow treatment)
Housing: Glass-filled PBT, UL94V-0
Reinforcing pin: Brass, copper-undercoated, tin-plated (reflow treatment)

RoHS compliance This product displays (LF)(SN) on a label.