

## MULTI-CIRCUIT SWITCHES

### Series—A3

### MIL-S-8805 or Industrial Grade Toggle Switches

FEATURES	SPECIFICATIONS	CURRENT RATINGS											
		No. of Poles	Part Number	Basic Switches	28VDC				115VAC				
					Inrush Load	Resistive Load	Inductive Load	Lamp Load	Inrush Load	Resistive Load	Inductive Load	Lamp Load	
<ul style="list-style-type: none"> <li>Two and three position</li> <li>Isolated circuitry</li> <li>Multi-circuit, compact 2, 4, 6, or 8 poles</li> <li>Maintained and momentary action</li> <li>Lever locking configurations</li> <li>Stainless steel construction</li> <li>Double turret terminals</li> </ul>	<ul style="list-style-type: none"> <li>Ambient operating temperature, -65°F to +165°F (-54°C to 74°C)</li> <li>Operating force 1 to 6 pounds (.22 to 1.35N)</li> <li>Electrical life: 25,000 operations minimum</li> <li>Mechanical life: 100,000 operations minimum</li> </ul>	2	A3-212 to A3-213	STD	25	7	4	2.5	20	7	7	2	
		4	A3-200 to A3-201	STD	25	7	4	2.5	20	7	7	2	
		6	A3-202 to A3-203	STD	25	7	4	2.5	20	7	7	2	
		8	A3-204 to A3-205	STD	25	7	4	2.5	20	7	7	2	
		2	A3-214 to A3-215	Sealed	24	5	3	2.4	15	5	5	1.5	
		4	A3-206 to A3-207	Sealed	24	5	3	2.4	15	5	5	1.5	
		6	A3-208 to A3-209	Sealed	24	5	3	2.4	15	5	5	1.5	
		8	A3-210 to A3-211	Sealed	24	5	3	2.4	15	5	5	1.5	

① 0.05 sec. duration.

TOGGLE SWITCHES

### SELECTION TABLE

TOGGLE POSITION & ACTION				WITH STANDARD BASIC SWITCHES			
Positions	Position #1 (On/Off)	Position #2 (Center)	Position #3 (On/Off)	2 Poles	4 Poles	6 Poles	8 Poles
<b>STANDARD (NON-LOCKING) TOGGLES</b>							
2 Position	On *On On	None None None	On* On On	A3-212-07 -06 -05	A3-200-07 -06 -05	A3-202-07 -06 -05	A3-204-07 -06 -05
3 Position	*On On *On On	Off Off Off Off	On* On* On On	A3-212-04 -03 -02 -01	A3-200-04 -03 -02 -01	A3-202-04 -03 -02 -01	A3-204-04 -03 -02 -01
<b>LEVER-LOCK TOGGLES (Complete by adding code letter from below after "slash")</b>							
2 Position	On *On On	None None None	On* On On	A3-213-07/ -06/ -05/	A3-201-07/ -06/ -05/	A3-203-07/ -06/ -05/	A3-205-07/ -06/ -05/
3 Position	*On On *On On	Off Off Off Off	On* On* On On	A3-213-04/ -03/ -02/ -01/	A3-201-04/ -03/ -02/ -01/	A3-203-04/ -03/ -02/ -01/	A3-205-04/ -03/ -02/ -01/
TOGGLE POSITION & ACTION				WITH SEALED BASIC SWITCHES			
Positions	Position #1 (On/Off)	Position #2 (Center)	Position #3 (On/Off)	2 Poles	4 Poles	6 Poles	8 Poles
<b>STANDARD (NON-LOCKING) TOGGLES</b>							
2 Position	On *On On	None None None	On* On On	A3-214-07 -06 -05	A3-206-07 -06 -05	A3-208-07 -06 -05	A3-210-07 -06 -05
3 Position	*On On *On On	Off Off Off Off	On* On* On On	A3-214-04 -03 -02 -01	A3-206-04 -03 -02 -01	A3-208-04 -03 -02 -01	A3-210-04 -03 -02 -01
<b>LEVER-LOCK TOGGLES (Complete by adding code letter from below after "slash")</b>							
2 Position	On *On On	None None None	On* On On	A3-215-07/ -06/ -05/	A3-207-07/ -06/ -05/	A3-209-07/ -06/ -05/	A3-211-07/ -06/ -05/
3 Position	*On On *On On	Off Off Off Off	On* On* On On	A3-215-04/ -03/ -02/ -01/	A3-207-04/ -03/ -02/ -01/	A3-209-04/ -03/ -02/ -01/	A3-211-04/ -03/ -02/ -01/

\*Momentary contact.

#### LEVER LOCKING CONFIGURATION SUFFIXES

- A** – Locked in three positions
- B** – Locked in center and extreme position ("D" flat side)
- D** – Locked out of center position
- E** – Locked in center position
- F** – Locked in extreme position (Opposite "D" flat)
- G** – Locked in extreme position ("D" flat side)
- H** – Locked out of center and extreme position ("D" flat side)

- J** – Locked out of center and extreme position (Opposite "D" flat)
- K** – Locked in center and extreme position (Opposite "D" flat)
- L** – Locked out of extreme position ("D" flat side)
- M** – Locked out of and into extreme position (Opposite "D" flat)
- N** – Locked out of extreme position (Opposite "D" flat)
- P** – Locked out of and into extreme position ("D" flat side)

## MULTI-CIRCUIT SWITCHES

## Multi-Circuit Toggle Switches

### APPROXIMATE DIMENSIONS

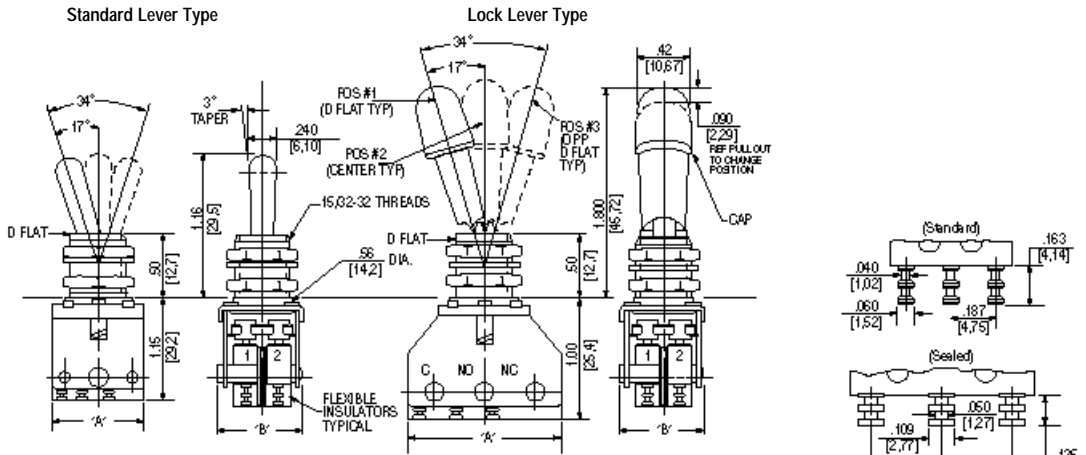

#### STANDARD

Max. Dimension	2 Pole	4 Pole	6 Pole	8 Pole
"A"	0.72 in. (18.3 mm)	1.30 in. (33.0 mm)	1.30 in. (33.0 mm)	1.30 in. (33.0 mm)
"B"	0.67 in. (17.0 mm)	.67 in. (17.0 mm)	.93 in. (23.6 mm)	1.17 in. (29.7 mm)

#### SEALED

Max. Dimension	2 Pole	4 Pole	6 Pole	8 Pole
"A"	1.22 in. (41.9 mm)	1.65 in. (41.9 mm)	1.65 in. (41.9 mm)	1.65 in. (41.9 mm)
"B"	0.67 in. (17.0 mm)	0.67 in. (17.0 mm)	0.93 in. (23.6 mm)	1.17 in. (29.7 mm)

### CROSS REFERENCE

### BACK CONFIGURATIONS

### SCHEMATIC DIAGRAMS

MIL-S-8805	Eaton Part Number
M8805/93-001	A3-212-1
M8805/93-002	A3-212-2
M8805/93-003	A3-212-3
M8805/93-004	A3-212-4
M8805/93-005	A3-212-5
M8805/93-006	A3-212-6
M8805/93-007	A3-212-7
M8805/93-008	A3-200-1
M8805/93-009	A3-200-2
M8805/93-010	A3-200-3
M8805/93-011	A3-200-4
M8805/93-012	A3-200-5
M8805/93-013	A3-200-6
M8805/93-014	A3-200-7
M8805/93-015	A3-202-1
M8805/93-016	A3-202-2
M8805/93-017	A3-202-3
M8805/93-018	A3-202-4
M8805/93-019	A3-202-5
M8805/93-020	A3-202-6
M8805/93-021	A3-202-7
M8805/93-022	A3-204-1
M8805/93-023	A3-204-2
M8805/93-024	A3-204-3
M8805/93-025	A3-204-4
M8805/93-026	A3-204-5
M8805/93-027	A3-204-6
M8805/93-028	A3-204-7

#### Standard

#### Sealed

2 Pt

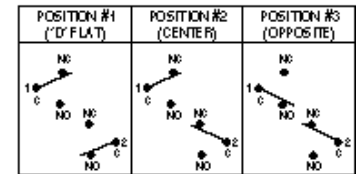
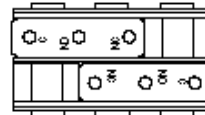
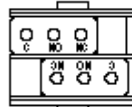

4 Pt

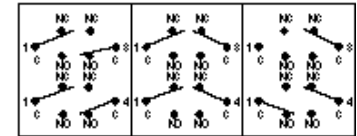
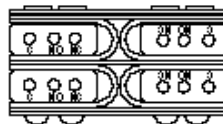

6 Pt

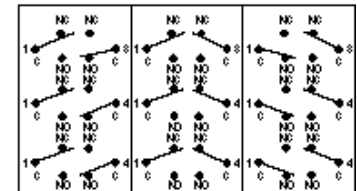
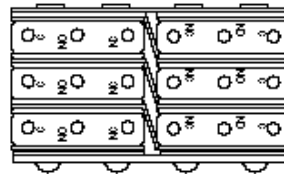
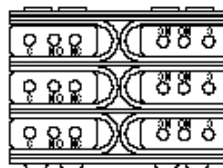

8 Pt

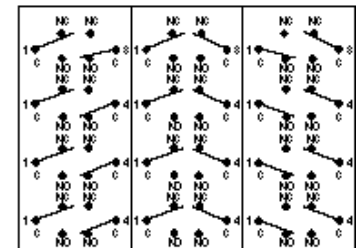
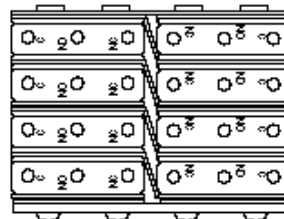
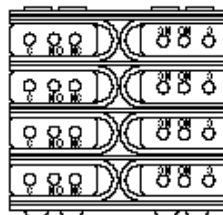

## MULTI-CIRCUIT SWITCHES

Series—A3

MIL-S-8805 or Industrial Grade Toggle Switches

### ORDERING EXAMPLES

- Standard - A3-206-03 equals a 3-position (ON-OFF-MOM ON) 4-pole switch with sealed basics.
- Lever Lock - A3-213-04/E equals a 3-position (MOM ON-OFF-MOMON) 2-pole switch with std. basics and E-lock.
- Available Locking Configurations (See table above. Add code letter after partial type number)

### LEVER LOCKING CONFIGURATION SUFFIXES - BUSHING STYLES

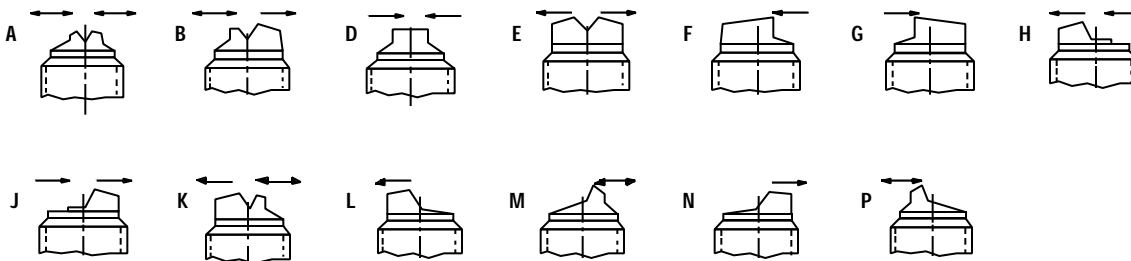

- Notes: 1. Arrows (<>) indicated lever must be unlocked to move against the arrow direction.  
 2. "D" flat is on the left side as viewed.

### OPTIONS

- Low level circuitry
- Pin type termination
- Quick Connect terminals
- Lever seal
- Various color caps available

### PANEL CUTOUT DIMENSIONS

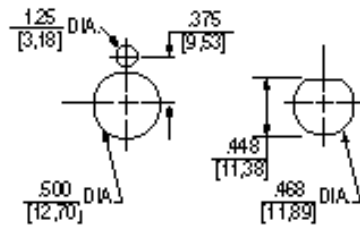

Recommended Panel Mounting Dimensions