

**LOW POWER, 12-BIT,
CMOS DACs**

FEATURES

- 12-bits binary or 3-decades BDC
- Low power: 300mW
- Commercial, industrial and MIL-STD-883 models
- 5 pin selectable output ranges

DESCRIPTION

The DAC349 Series are versatile, low power 12-bit D/A converters that are intended for fixed reference applications. These units combine a novel CMOS switching technique with a precision, ultra-stable thin-film ladder to achieve accurate conversion with low power drain; improved reliability and near-instantaneous warmup are major advantages of reduced power consumption. All models include an internal precision reference and a gain-selectable output amplifier.

The DAC349 Series offers a choice of either 12-bit binary coding (-12 models) or 3 decade BCD coding (-3D models).

By external pin jumpering, the binary models can be connected for unipolar output ranges of 0 to

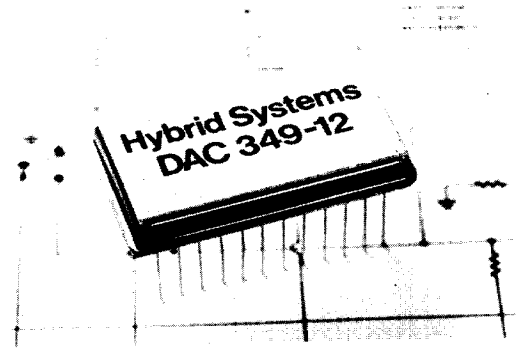

-5V or 0 to -10V and for offset binary coded bipolar outputs of $\pm 2.5V$, $\pm 5V$ and $\pm 10V$. For ratiometric applications, the units operate from an external fixed DC reference of $-10V \pm 10\%$.

Both binary and BCD models are available in commercial/industrial and MIL-STD-883 Rev. C, Level B versions. The DAC349B is specified over a temperature range of $-55^{\circ}C$ to $+125^{\circ}C$. Both versions operate $-55^{\circ}C$ to $+125^{\circ}C$.

7

FUNCTIONAL DIAGRAM

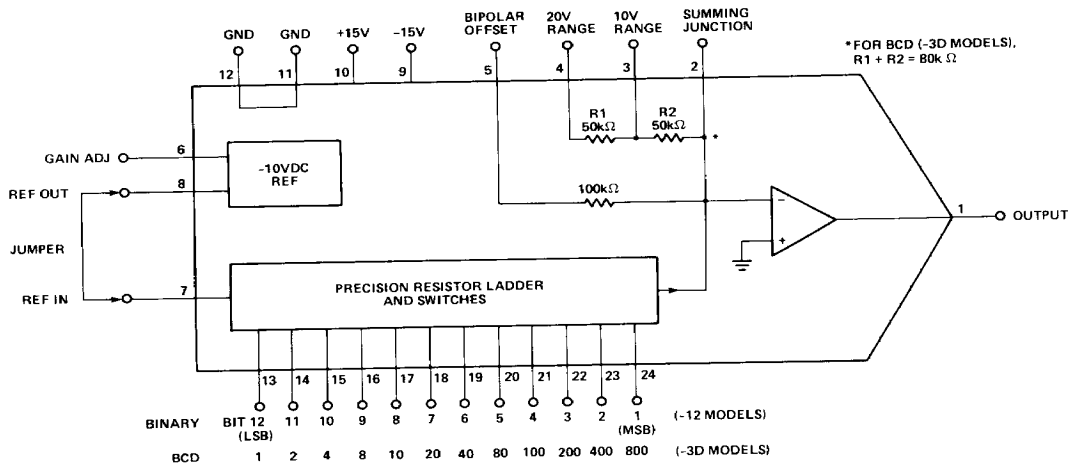

SPECIFICATIONS

(Typical @ +25°C and nominal power supplies unless otherwise noted)

SERIES	DAC349
TYPE	Fixed Reference, Voltage Output
DIGITAL INPUT	
Resolution	12 Bits Binary (-12) or 3 Decades BCD (-3D)
Unipolar Coding	Binary or BCD
Bipolar Coding	Offset Binary
Logic Levels	
Binary	$V_{IH}=2.4V$ min, $V_{IL}=0.8V$ max
BCD	$V_{IH}=3.5V$ min, $V_{IL}=1.5V$ max
Input Current	$\pm 1\mu A$ max
ANALOG OUTPUT	
Voltage Range	0 to -5V, 0 to -10 $\pm 2.5V$, $\pm 5V$, $\pm 10V$
Current Compliance	$\pm 5mA$ (min)
Impedance	< 0.1
Scale Factor ¹	$\pm 0.1\%$ of F.S.R. (max)
Unipolar Offset ¹	$\pm 0.2\%$ of F.S.R. (max)
Bipolar Offset ¹	$\pm 0.1\%$ of F.S.R. (max)
REFERENCE	
Internal ²	-10VDC
External (D.C. only)	-10VDC $\pm 10\%$ @ 1mA
STATIC PERFORMANCE	
Linearity	$\pm \frac{1}{2}$ LSB (max)
Differential Linearity	± 1 LSB (max)
DYNAMIC PERFORMANCE	
Settling Time	15 μs (max)
Slew Rate	1V/ μs
STABILITY	
Accuracy vs Temp. ³	30ppm/ $^{\circ}C$ (max)
Linearity vs Temp.	5ppm/ $^{\circ}C$ (max)
Differential Linearity vs Temp.	2ppm/ $^{\circ}C$ (max)
POWER SUPPLY	
Voltage @ Current	+15V @ 5mA (nom): 10mA (max) +13V to +18V; -15V @ 15mA (nom): 20mA (max) -13V to -18V
Rejection Ratio	0.005%/%
Power Consumption	375mW (max)
TEMPERATURE RANGE	
Specified	
DAC349C	-25°C to +85°C
DAC349B	-55°C to +125°C
Operating, All models	-55°C to +125°C
Storage, All models	-65°C to +150°C
MECHANICAL	
Case Style	Ceramic

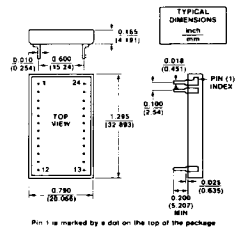

- NOTES:**
- Offset and gain are externally adjustable. See APPLICATIONS INFORMATION.
 - For specified overall performance, external loading of the reference output (Pin 8) must not exceed 1.0 mA.
 - Total effect of linearity, offset and gain tempco's on the transfer characteristics of the unit.
 - In case of discrepancy between package shown in photograph and package outline dimension, the mechanical outline is correct.

Specifications subject to change without notice.

APPLICATIONS INFORMATION

RECOMMENDED POWER SUPPLY BYPASS CIRCUIT **RECOMMENDED BURN-IN CIRCUIT**
(Standard for MIL-STD-883 Models)

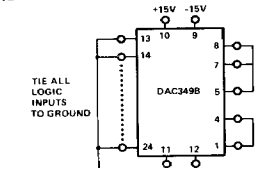
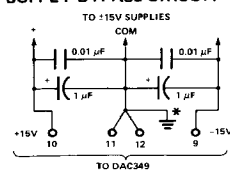

* SINGLE POINT GROUND WHERE POSSIBLE

OPTIONAL ADJUSTMENTS

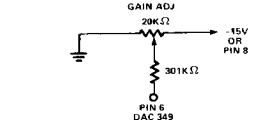
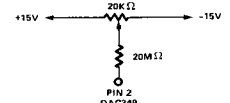

- Binary Unipolar Operation:**
- Apply a 0 0 0 ... 0 input code and set the OFFSET ADJ pot for 0V out.
 - Apply a 1 1 1 ... 1 input code and set the GAIN ADJ pot for -(F.S. - 1 LSB).
- Binary Bipolar Operation:**
- Apply a 1 0 0 ... 0 input code and set the OFFSET ADJ pot for a zero output.
 - Apply a 1 1 1 ... 1 input code and set the GAIN ADJ pot for -(F.S. - 1 LSB).
- BCD Unipolar Operation:**
- Apply a 0 0 0 ... 0 input code and set the OFFSET ADJ pot for 0V out.
 - Apply 1001 1001 1001 input and set the GAIN ADJ pot for -9.990V.

RANGE SCALING*

Output Voltage Range	Jumper These Pins	Connect Pin 5 to Pin	Coding
0 to -5V	1 & 3, 2 & 4	11	Binary
0 to -10V	1 & 3	11	
0 to -9.99V	1 & 4	**	BCD
$\pm 2.5V$	1 & 3	7	Offset Binary
$\pm 5V$	2 & 4	7	
$\pm 10V$	1 & 3	7	
$\pm 10V$	1 & 4	7	

* Pin 7 must be connected to either the internal reference (Pin 8) or to an external -10VDC reference source.
** No connection on BCD (-3D) models.

TRANSFER CHARACTERISTICS

Binary Unipolar Operation		BCD Unipolar Operation	
Digital Input	Analog Output	Digital Input	Analog Output
1 1 1 ... 1	-(F.S. - 1 LSB)	1001 1001 1001	-9.99
1 0 0 ... 0	-F.S./2	0101 0000 0000	-5.00
0 0 0 ... 0	0V	0000 0000 0000	0V

Binary Bipolar Operation

Digital Input	Analog Output
1 1 1 ... 1	-(F.S. - 1 LSB)
1 0 0 ... 0	0V
0 0 0 ... 0	+F.S.

ORDERING INFORMATION

MODEL	DESCRIPTION
DAC349C-12	Comm, 12-Bit, -25°C to +85°C
DAC349C-3D	Comm, 3-Decade, -25°C to +85°C
DAC349B-12	MIL, 12-Bit, -55°C to +125°C
DAC349B-3D	MIL, 3-Decade, -55°C to +125°C

CAUTION: ESD (Electro-Static Discharge) sensitive device. Permanent damage may occur when unconnected devices are subjected to high energy electrostatic fields. Unless otherwise noted, the voltage at any digital input should never exceed the supply voltage by more than 0.5 volts or go below -0.5 volts.

