

# Surface Mount Aluminum Electrolytic Capacitors NATT Series

## FEATURES

- CYLINDRICAL V-CHIP CONSTRUCTION FOR SURFACE MOUNTING
- AVAILABLE WITH ANTI-VIBRATION WIDE TERMINATIONS
- EXTENDED TEMPERATURE & LOAD LIFE (1,000 ~ 2,000 HOURS @ +125°C)
- SUITABLE FOR DC-DC CONVERTER, DC-AC INVERTER, ETC.
- DESIGNED FOR AUTOMATIC MOUNTING AND REFLOW SOLDERING

SAC Alloy Compatible  
230°C ~ 260°C

**RoHS Compliant**  
includes all homogeneous materials



## CHARACTERISTICS

\*See Part Number System for Details

Rated Voltage Rating	6.3 ~ 100Vdc								
Rated Capacitance Range	1.0 ~ 4,700μF								
Operating Temp. Range	-40 ~ +125°C								
Capacitance Tolerance	±20% (M)								
Max. Leakage Current After 2 Minutes @ 20°C	0.01CV or 3μA whichever is greater								
Tan δ @ 120Hz/20°C	W.V. (Vdc)	6.3	10	16	25	35	50	63	100
	S.V. (Vdc)	8.0	13	20	32	44	63	79	125
	Tan δ	0.30	0.24	0.20	0.16	0.14	0.14	0.12	0.10
Low Temperature Stability Impedance Ratio @ 120Hz	W.V. (Vdc)	6.3	10	16	25	35	50	63	100
	Z-25°C/Z+20°C	4	3	2	2	2	2	2	2
	Z-40°C/Z+20°C	8	6	4	3	3	3	3	3
Load Life Test @ 125°C 1,000 ~ 2,000 hours (see specifications tables for specific part numbers)	Capacitance Change	Within ±30% of initial measured value							
	Tan δ	Less than ±300% of the specified maximum value							
	Leakage Current	Less than the specified maximum value							

**LOW ESR COMPONENT**  
LIQUID ELECTROLYTE  
For Performance Data see [www.LowESR.com](http://www.LowESR.com)

## STANDARD VALUES AND CASE SIZES (mm)

Cap (μF)	Code	Working Voltage (Vdc)							
		6.3	10	16	25	35	50	63	100
1.0	1R0	-	-	-	-	-	6.3x6.3	-	-
2.2	2R2	-	-	-	-	-	6.3x6.3	-	-
3.3	3R3	-	-	-	-	-	6.3x6.3	-	-
4.7	4R7	-	-	-	-	6.3x6.3	6.3x6.3	-	-
10	100	-	-	-	-	6.3x6.3	6.3x6.3	-	8x10.5
22	220	-	-	-	-	6.3x6.3	6.3x8	8x10.5	8x10.5
33	330	-	-	-	6.3x6.3	6.3x8	6.3x8	8x10.5	10x10.5
							8x10.5		
47	470	-	6.3x6.3	6.3x6.3	6.3x8	6.3x8	8x10.5	8x10.5	12.5x14
						8x10.5	10x10.5	10x10.5	
100	101	6.3x6.3	6.3x8	8x10.5	6.3x8	8x10.5	10x10.5	10x10.5	16x17
					8x10.5	10x10.5	12.5x14	12.5x14	
220	221	6.3x8	6.3x8	8x10.5	8x10.5	10x10.5	12.5x14	12.5x14	-
			8x10.5		10x10.5	12.5x14	16x17		
330	331	8x10.5	8x10.5	10x10.5	10x10.5	12.5x14	12.5x14	16x17	-
					12.5x14	16x17	16x17		
470	471	8x10.5	10x10.5	12.5x14	12.5x14	12.5x14	16x17	16x17	-
680	681	10x10.5	12.5x14	12.5x14	12.5x14	16x17	16x17	-	-
1000	102	12.5x14	12.5x14	12.5x14	16x17	16x17	-	-	-
1500	152	12.5x14	12.5x14	16x17	16x17	-	-	-	-
2200	222	12.5x14	16x17	16x17	-	-	-	-	-
3300	332	16x17	16x17	-	-	-	-	-	-
4700	472	16x17	-	-	-	-	-	-	-

## PEAK REFLOW TEMPERATURE CODES

Code	Peak Reflow Temperature
N	260°C
L	250°C
K	245°C
J	240°C
H	235°C

## TERMINATION FINISH & PACKAGING OPTIONS CODES

Code	Finish & Reel Size
B	Sn-Bi Finish & 13" Reel
LB	Sn-Bi Finish & 15" Reel
S	100% Sn Finish & 13" Reel
LS	100% Sn Finish & 15" Reel

## DIMENSIONS (mm) AND REEL QUANTITIES

Case Size	φD±0.5	L max.	A±0.2	B±0.2	I±0.3	W	P±0.3	Qty/Reel
6.3x6.3	6.3	6.3	6.6	6.6	2.5	0.5~0.8	2.2	800
6.3x8	6.3	8.0	6.6	6.6	2.5	0.5~0.8	2.2	500
8x10.5	8.0	10.5	8.3	8.3	2.9	0.7~1.0	3.2	300
10x10.5	10.0	10.5	10.3	10.3	3.2	1.1~1.4	4.6	300
12.5x14	12.5	14.0	12.8	12.8	4.5	1.1~1.4	4.6	200
16x17	16.0	17.0	16.3	16.3	5.5	1.8~2.1	7.0	125

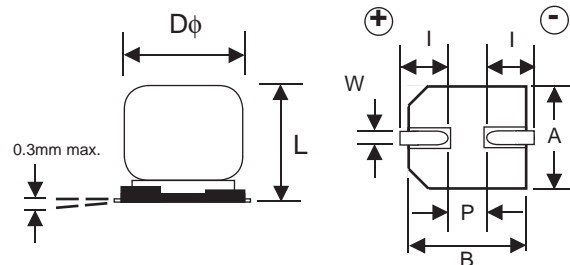

# Surface Mount Aluminum Electrolytic Capacitors NATT Series

## STANDARD VALUES, CASE SIZES AND SPECIFICATIONS

NIC Part Number	Cap. (μF)	W.V. (Vdc)	Dissipation Factor (Tan δ)	Max. Impedance (Ω) 100KHz, +20°C	Max. Ripple Current (mA) +125°C, 100KHz	Load Life Hours @ +125°C
NATT101M6.3V6.3X6.3NBF	100	6.3	0.30	1.60	70	1,000
NATT221M6.3V6.3X8NBF	220		0.30	0.90	100	1,000
NATT331M6.3V8X10.5NBF	330		0.30	0.40	160	2,000
NATT471M6.3V8X10.5NBF	470		0.30	0.40	160	2,000
NATT681M6.3V10X10.5LBF	680		0.30	0.30	220	2,000
NATT102M6.3V12.5X14JBF	1000		0.30	0.12	550	2,000
NATT152M6.3V12.5X14JBF	1500		0.30	0.12	550	2,000
NATT222M6.3V12.5X14JBF	2200		0.30	0.12	550	2,000
NATT332M6.3V16X17HSF	3300		0.30	0.08	900	2,000
NATT472M6.3V16X17HSF	4700		0.30	0.08	900	2,000
NATT470M10V6.3X6.3NBF	47	10	0.24	1.60	70	1,000
NATT101M10V6.3X8NBF	100		0.24	0.90	100	1,000
NATT221M10V6.3X8NBF	220		0.24	0.90	100	1,000
NATT221M10V8X10.5NBF	220		0.24	0.40	160	2,000
NATT331M10V8X10.5NBF	330		0.24	0.40	160	2,000
NATT471M10V10X10.5LBF	470		0.24	0.30	220	2,000
NATT681M10V12.5X14JBF	680		0.24	0.12	550	2,000
NATT102M10V12.5X14JBF	1000		0.24	0.12	550	2,000
NATT152M10V12.5X14JBF	1500		0.24	0.12	550	2,000
NATT222M10V16X17HSF	2200		0.24	0.08	900	2,000
NATT332M10V16X17HSF	3300	0.24	0.08	900	2,000	
NATT470M16V6.3X6.3NBF	47	16	0.20	1.60	70	1,000
NATT101M16V8X10.5NBF	100		0.20	0.40	160	2,000
NATT221M16V8X10.5NBF	220		0.20	0.40	160	2,000
NATT331M16V10X10.5LBF	330		0.20	0.30	220	2,000
NATT471M16V12.5X14JBF	470		0.20	0.12	550	2,000
NATT681M16V12.5X14JBF	680		0.20	0.12	550	2,000
NATT102M16V12.5X14JBF	1000		0.20	0.12	550	2,000
NATT152M16V16X17HSF	1500		0.20	0.08	900	2,000
NATT222M16V16X17HSF	2200		0.20	0.08	900	2,000
NATT330M25V6.3X6.3NBF	33		25	0.16	1.60	70
NATT470M25V6.3X8NBF	47	0.16		0.90	100	1,000
NATT101M25V6.3X8NBF	100	0.16		0.90	100	1,000
NATT101M25V8X10.5NBF	100	0.16		0.40	160	2,000
NATT221M25V8X10.5NBF	220	0.16		0.40	160	2,000
NATT221M25V10X10.5LBF	220	0.16		0.30	220	2,000
NATT331M25V10X10.5LBF	330	0.16		0.30	220	2,000
NATT331M25V12.5X14JBF	330	0.16		0.12	550	2,000
NATT471M25V12.5X14JBF	470	0.16		0.12	550	2,000
NATT681M25V12.5X14JBF	680	0.16		0.12	550	2,000
NATT102M25V16X17HSF	1000	0.16	0.08	900	2,000	
NATT152M25V16X17HSF	1500	0.16	0.08	900	2,000	
NATT4R7M35V6.3X6.3NBF	4.7	35	0.14	2.00	60	1,000
NATT100M35V6.3X6.3NBF	10		0.14	1.60	70	1,000
NATT220M35V6.3X6.3NBF	22		0.14	1.60	70	1,000
NATT330M35V6.3X8NBF	33		0.14	0.90	100	1,000
NATT470M35V6.3X8NBF	47		0.14	0.90	100	1,000
NATT470M35V8X10.5NBF	47		0.14	0.40	160	2,000
NATT101M35V8X10.5NBF	100		0.14	0.40	160	2,000
NATT101M35V10X10.5LBF	100		0.14	0.30	220	2,000
NATT221M35V10X10.5LBF	220		0.14	0.30	220	2,000
NATT221M35V12.5X14JBF	220		0.14	0.12	550	2,000
NATT331M35V12.5X14JBF	330		0.14	0.12	550	2,000
NATT471M35V12.5X14JBF	470		0.14	0.12	550	2,000
NATT471M35V16X17HSF	470		0.14	0.08	900	2,000
NATT681M35V16X17HSF	680		0.14	0.08	900	2,000
NATT102M35V16X17HSF	1000		0.14	0.08	900	2,000

For Automotive Equipment, see part number system



# Surface Mount Aluminum Electrolytic Capacitors NATT Series

## STANDARD VALUES, CASE SIZES AND SPECIFICATIONS

NIC Part Number	Cap. (μF)	W.V. (Vdc)	Dissipation Factor (Tan δ)	Max. Impedance (Ω) 100KHz, +20°C	Max. Ripple Current (mA) +125°C, 100KHz	Load Life Hours @ +125°C
NATT1R0M50V6.3X6.3NBF	1.0	50	0.14	3.50	45	1,000
NATT2R2M50V6.3X6.3NBF	2.2		0.14	3.50	45	1,000
NATT3R3M50V6.3X6.3NBF	3.3		0.14	3.50	45	1,000
NATT4R7M50V6.3X6.3NBF	4.7		0.14	3.50	45	1,000
NATT100M50V6.3X6.3NBF	10		0.14	2.80	50	1,000
NATT220M50V6.3X8NBF	22		0.14	2.00	80	1,000
NATT330M50V6.3X8NBF	33		0.14	2.00	80	1,000
NATT330M50V8X10.5NBF	33		0.14	0.70	140	2,000
NATT470M50V8X10.5NBF	47		0.14	0.70	140	2,000
NATT470M50V10X10.5LBF	47		0.14	0.50	240	2,000
NATT101M50V10X10.5LBF	100		0.14	0.50	240	2,000
NATT101M50V12.5X14JBF	100		0.14	0.23	490	2,000
NATT221M50V12.5X14JBF	220		0.14	0.23	490	2,000
NATT331M50V12.5X14JBF	330		0.14	0.23	490	2,000
NATT331M50V16X17HSF	330		0.14	0.15	800	2,000
NATT471M50V16X17HSF	470		0.14	0.15	800	2,000
NATT681M50V16X17HSF	680		0.14	0.15	800	2,000
NATT220M63V8X10.5KBF	22	63	0.12	1.0	100	1,500
NATT330M63V8X10.5KBF	33		0.12	1.0	100	1,500
NATT470M63V8X10.5KBF	47		0.12	1.0	100	1,500
NATT470M63V10X10.5JBF	47		0.12	0.5	150	1,500
NATT101M63V10X10.5JBF	100		0.12	0.5	150	1,500
NATT101M63V12.5X14JBF	100		0.12	0.25	350	1,500
NATT221M63V12.5X14JBF	220		0.12	0.25	350	1,500
NATT221M63V16X17HSF	220		0.12	0.18	500	1,500
NATT331M63V16X17HSF	330		0.12	0.18	500	1,500
NATT471M63V16X17HSF	470	0.12	0.18	500	1,500	
NATT100M100V8X10.5JBF	10	100	0.10	1.00	70	1,500
NATT220M100V8X10.5JBF	22		0.10	1.00	70	1,500
NATT330M100V10X10.5JBF	33		0.10	0.80	115	1,500
NATT470M100V12.5X14HBF	47		0.10	0.33	350	1,500
NATT101M100V16X17HSF	100		0.10	0.24	500	1,500

For Automotive Equipment, see part number system

### PART NUMBER SYSTEM

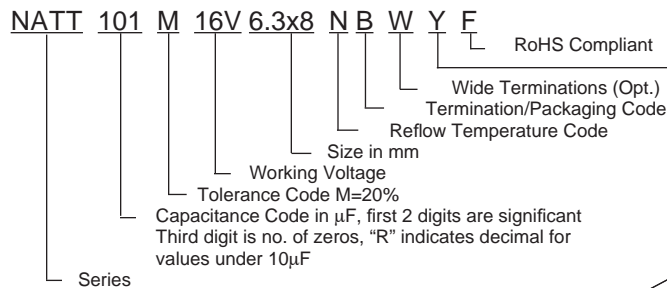

Optional: Suitable for automotive equipment, sourced to special production and inspection at TS-16949 certified production site

### PRECAUTIONS

Please review the notes on correct use, safety and precautions found on pages T10 & T11 of NIC's Electrolytic Capacitor catalog.  
Also found at [www.niccomp.com/precautions](http://www.niccomp.com/precautions)  
If in doubt or uncertainty, please review your specific application - process details with NIC's technical support personnel: [tpmg@niccomp.com](mailto:tpmg@niccomp.com)



# Surface Mount Aluminum Electrolytic Capacitors NATT Series

## PEAK REFLOW TEMPERATURE & DURATION (6.3 ~ 50V)

Diameter	Time above 200°C	Time above 230°C	Peak Temperature 5 seconds
6.3mm ~ 8mm $\phi$	80 sec. max.	40 sec. max.	260°C
10mm $\phi$	70 sec. max.	40 sec. max.	250°C
12.5mm $\phi$	50 sec. max.	20 sec. max.	240°C
16mm $\phi$	50 sec. max.	15 sec. max.	235°C

## PEAK REFLOW TEMPERATURE & DURATION (63V)

Diameter	Time above 200°C	Time above 230°C	Peak Temperature 5 seconds
8mm $\phi$	60 sec. max.	30 sec. max.	245°C
10mm $\phi$	50 sec. max.	20 sec. max.	240°C
12.5mm $\phi$	50 sec. max.	20 sec. max.	240°C
16mm $\phi$	50 sec. max.	15 sec. max.	235°C

## PEAK REFLOW TEMPERATURE & DURATION (100V)

Diameter	Time above 200°C	Time above 230°C	Peak Temperature 5 seconds
8mm $\phi$	60 sec. max.	30 sec. max.	240°C
10mm $\phi$	50 sec. max.	20 sec. max.	240°C
12.5mm $\phi$	50 sec. max.	20 sec. max.	235°C
16mm $\phi$	45 sec. max.	10 sec. max.	235°C

Capacitors can withstand two times reflow at the above conditions. Second reflow shall be at least one hour after natural cool to room temperature.

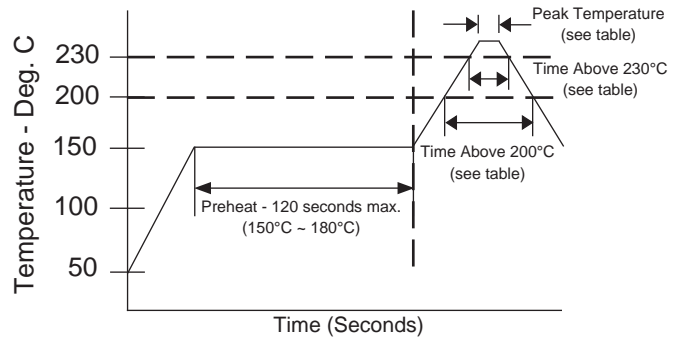

## RECOMMENDED LAND PATTERN DIMENSIONS (mm)

Case Size	a	b	c
6x3x6.3 6.3x8	2.1	3.5	1.8
8x10.5	2.8	4.1	2.1
10x10.5	4.3	4.4	2.5
12.5x14	4.3	5.8	2.5
16x17	6.6	6.5	5.0

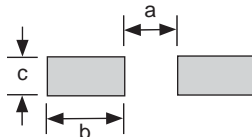

## WIDE TERMINATION (WT) DIM. (mm)

Case Size	D $\phi$ $\pm$ 0.5	L max.	A, B	C $\pm$ 0.2	P $\pm$ 0.2	W	R	T
8 x 10.5WT	8.0	10.5	8.3 $\pm$ 0.2	9.0	3.2	0.7 ~ 1.0	(0.7)	(1.3)
10 x 10.5WT	10.0	10.8	10.3 $\pm$ 0.2	11.0	4.6	1.0 ~ 1.4	(0.7)	(1.3)
12.5 x 14WT	12.5	14.3	13.5 $\pm$ 0.2	14.2	4.6	1.0 ~ 1.4	(2.2)	(2.4)
16 x 17WT	16.0	17.5	17.0 $\pm$ 0.2	18.0	7.0	1.8 ~ 2.1	(3.0)	(2.0)

## WT LAND PATTERN DIM. (mm)

Case Size	a	b	c
8x10.5	2.5	4.5	4.7
10x10.5	3.8	4.8	4.7
12.5x14	3.8	6.1	6.9
16x17	5.0	8.0	9.5

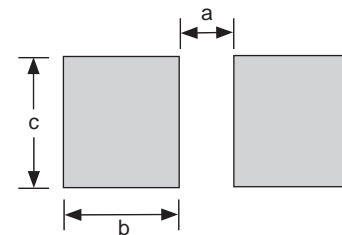
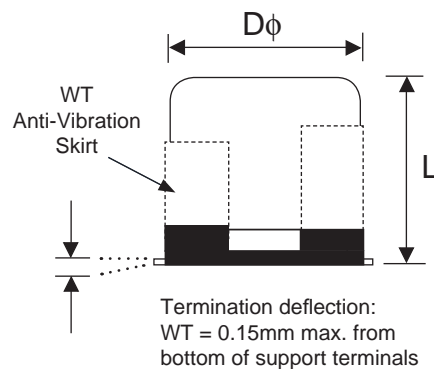
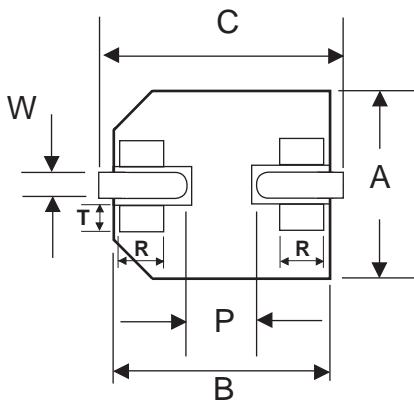

Review & Compare Reflow Soldering Heat Limits  
V-chip SMT Aluminum Electrolytic Capacitors  
[www.nicomp.com/RSL](http://www.nicomp.com/RSL)



# Surface Mount Aluminum Electrolytic Capacitors Case Size Data

## CASE DIMENSIONS (mm)\*

Case Size	D $\phi$ $\pm 0.5$	L max.	A $\pm 0.2$	B $\pm 0.2$	l $\pm 0.2$	W	P $\pm 0.2$	R	S	T
3 x 5.5	3.0	5.5	3.3	3.3	1.5	0.45 ~ 0.8	0.6	-	-	-
4 x 4.6	4.0	4.6	4.3	4.3	1.8	0.5 ~ 0.8	1.0	-	-	-
4 x 5.5	4.0	5.5	4.3	4.3	1.8	0.5 ~ 0.8	1.0	-	-	-
4 x 6.1	4.0	6.1	4.3	4.3	1.8	0.5 ~ 0.8	1.0	-	-	-
4 x 6.3	4.0	6.3	4.3	4.3	1.8	0.5 ~ 0.8	1.0	-	-	-
5 x 4.6	5.0	4.6	5.3	5.3	2.1	0.5 ~ 0.8	1.4	-	-	-
5 x 5.5	5.0	5.5	5.3	5.3	2.1	0.5 ~ 0.8	1.4	-	-	-
5 x 6.1	5.0	6.1	5.3	5.3	2.2	0.5 ~ 0.8	1.5	-	-	-
5 x 6.3	5.0	6.3	5.3	5.3	2.2	0.5 ~ 0.8	1.5	-	-	-
6.3 x 4.6	6.3	4.6	6.6	6.6	2.5	0.5 ~ 0.8	2.2	-	-	-
6.3 x 5.5	6.3	5.5	6.6	6.6	2.5	0.5 ~ 0.8	2.2	-	-	-
6.3 x 6.1	6.1	6.6	6.6	6.6	2.6	0.5 ~ 0.8	1.8	-	-	-
6.3 x 6.3	6.3	6.3	6.6	6.6	2.5	0.5 ~ 0.8	2.2	-	-	-
6.3 x 8	6.3	8.0	6.6	6.6	2.5	0.5 ~ 0.8	2.2	-	-	-
8 x 6.5	8.0	6.5	8.3	8.3	3.4	0.5 ~ 0.8	2.2	-	-	-
8 X 10.5	8.0	10.5	8.3	8.3	2.9	0.7 ~ 1.0	3.2	-	-	-
8 X 10.8	8.0	10.8	8.3	8.3	2.9	0.7 ~ 1.0	3.2	-	-	-
10 x 8	10.0	8.0	10.3	10.3	3.2	0.7 ~ 1.4	4.6	-	-	-
10 x 10.5	10.0	10.5	10.3	10.3	3.2	0.7 ~ 1.4	4.6	-	-	-
10 x 10.8	10.0	10.8	10.3	10.3	3.2	0.7 ~ 1.4	4.6	-	-	-
10 x 14	10.0	14.0	10.3	10.3	3.5	0.7 ~ 1.4	4.6	-	-	-
10 x 18	10.0	18.5	10.3	10.3	3.5	1.1 ~ 1.4	4.6	-	-	-
10 x 22	10.0	22.5	10.3	10.3	3.5	1.1 ~ 1.4	4.6	-	-	-
12.5 x 14	12.5	14.0	12.8	12.8	4.5	0.6 ~ 1.4	4.6	-	-	-
12.5 x 14WT	12.5	14.0	12.8	12.8	4.5	0.9 ~ 1.5	4.6	-	-	-
12.5 x 17T2	12.5	17.5	13.5	13.5	4.7	0.6 ~ 1.2	4.4	-	-	-
12.5 x 17WT	12.5	17.5	13.5	13.5	4.7	0.9 ~ 1.5	4.4	2.2	7.1	2.4
12.5 x 22	12.5	22.5	13.5	13.5	4.7	0.6 ~ 1.2	4.4	-	-	-
16 x 17T2	16.0	17.5	17.0	17.0	5.5	1.8 ~ 2.1	6.7	-	-	-
16 x 17WT	16.0	17.5	17.0	17.0	5.5	1.8 ~ 2.1	6.7	3.0	9.0	1.9
16 x 22T2	16.0	22.5	17.0	17.0	5.5	0.9 ~ 1.5	6.7	-	-	-
16 x 22WT	16.0	22.5	17.0	17.0	5.5	1.2 ~ 1.6	6.7	3.0	9.0	1.9
18 x 17T2	18.0	17.5	19.0	19.0	6.5	0.9 ~ 1.5	6.7	-	-	-
18 x 17WT	18.0	17.5	19.0	19.0	6.5	1.2 ~ 1.6	6.7	3.0	11.0	1.9
18 x 22T2	18.0	22.5	19.0	19.0	6.5	0.9 ~ 1.5	6.7	-	-	-
18 x 22WT	18.0	22.5	19.0	19.0	6.5	1.2 ~ 1.6	6.7	3.0	11.0	1.9

Anti-Vibration Skirt  
NACK & NACZF  
12.5, 16 & 18mm

H<sub>1</sub> 12.5mm Dia. = 9mm  
16 & 18mm Dia = 10mm

H<sub>2</sub> 12.5mm Dia. = 10mm  
16 & 18mm Dia = 11mm

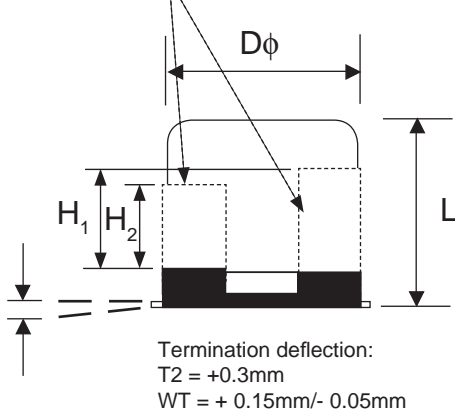

### T2 STYLE

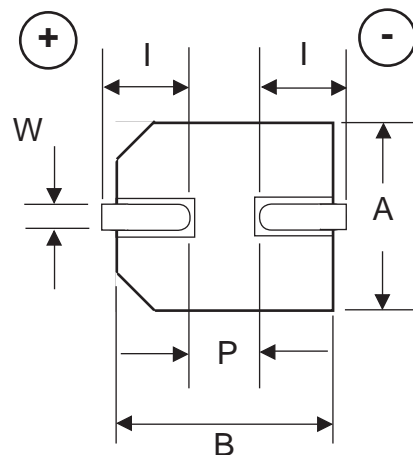

### WT STYLE

