

SKY67221-11: 1.6-2.1 GHz Low-Noise Amplifier Module

Applications

- GSM, CDMA, UMTS, WCDMA, and LTE systems
- Cellular infrastructure
- Ultra low-noise systems

Features

- Requires only one external component
- Optimized for 1.6 to 2.1 GHz operation
- Noise Figure: 0.90 dB typical @ 1.95 GHz
- Gain: 18.6 dB typical @ 1.95 GHz
- Input return loss: >25 dB typical @ 1.95 GHz
- Operating voltage range: 3.3 to 5.0 V
- Adjustable supply current: 30 to 120 mA
- High linearity IIP3: +18.4 dBm typical @ 1.95 GHz
- MCM (16-pin, 4 x 4 mm) package (MSL3, 260 °C per JEDEC J-STD-020) package



Skyworks Green™ products are compliant with all applicable legislation and are halogen-free. For additional information, refer to Skyworks Definition of Green™, document number SQ04-0074.

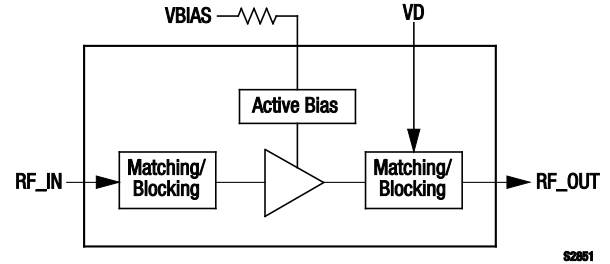

Figure 1. SKY67221-11 LNA Block Diagram

Description

The SKY67221-11 is a high performance, Low-Noise Amplifier (LNA) designed for use in 1.6 to 2.1 GHz wireless infrastructure applications. The device consists of a single high linearity, GaAs pHEMT LNA and all associated matching components. The only external component necessary for proper operation is an external resistor, used to set the DC current. The device is also completely DC bypassed.

The package design nearly eliminates external surface mount components, greatly reduces printed circuit board area, and offers low thermal resistance for enhanced Mean Time Between Failures (MTBFs).

For optimum performance in the following frequency ranges, refer to the following product Data Sheets (all devices are pin-to-pin compatible with the SKY67221-11):

- 0.4 GHz to 0.7 GHz: SKY67215-11 (document #201842)
- 0.7 GHz to 1.2 GHz: SKY67216-11 (document #201808)
- 2.2 GHz to 3.0 GHz: SKY67226-11 (document #201841)

The SKY67221-11 is packaged in a 16-pin, 4 x 4 mm Multi-Chip Module (MCM). A block diagram of the SKY67221-11 is shown in Figure 1. The device package and pinout are shown in Figure 2.

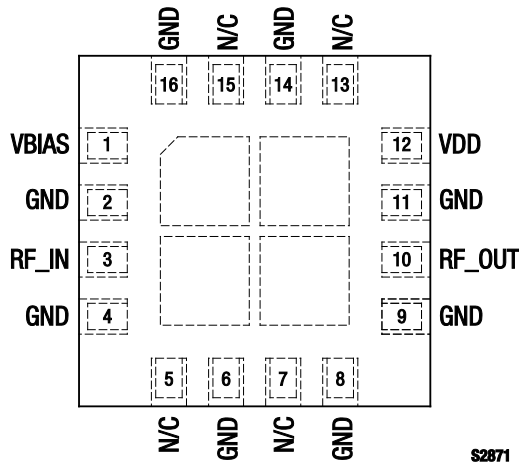

Figure 2. SKY67221-11 Pinout – 16-Pin MCM Package (Top View)

Electrical and Mechanical Specifications

Signal pin assignments and functional pin descriptions are described in Table 1. The absolute maximum ratings of the SKY67221-11 are provided in Table 2. Electrical specifications are provided in Tables 3, 4, and 5.

Typical performance characteristics of the SKY67221-11 are illustrated in Figures 3 through 24 (85 mA supply current).

Package and Handling Information

Since the device package is sensitive to moisture absorption, it is baked and vacuum packed before shipping. Instructions on the shipping container label regarding exposure to moisture after the

container seal is broken must be followed. Otherwise, problems related to moisture absorption may occur when the part is subjected to high temperature during solder assembly.

The SKY67221-11 is rated to Moisture Sensitivity Level 3 (MSL3) at 260 °C. It can be used for lead or lead-free soldering. For additional information, refer to the Skyworks Application Note *PCB Design and SMT Assembly/Rework Guidelines for MCM-L Packages*, document number 101752.

Care must be taken when attaching this product, whether it is done manually or in a production solder reflow environment. Production quantities of this product are shipped in a standard tape and reel format.

Table 1. SKY67221-11 Signal Descriptions

| Pin # | Name | Description | Pin # | Name | Description |
|-------|-------|---|-------|--------|---|
| 1 | VBIAS | Low current bias for amplifier. External resistor sets current consumption. | 9 | GND | Ground |
| 2 | GND | Ground | 10 | RF_OUT | RF output, AC coupled. No external components required. |
| 3 | RF_IN | RF input, AC coupled. No external components required. | 11 | GND | Ground |
| 4 | GND | Ground | 12 | VDD | High current amplifier bias connection. No external bypassing required. |
| 5 | N/C | No connection | 13 | N/C | No connection |
| 6 | GND | Ground | 14 | GND | Ground |
| 7 | N/C | No connection | 15 | N/C | No connection |
| 8 | GND | Ground | 16 | GND | Ground |

Table 2. Absolute Maximum Ratings

| Parameter | Symbol | Minimum | Maximum | Units |
|-----------------------|------------------|---------|---------|-------|
| Supply voltage | V _{DD} | | 5.5 | V |
| RF input power | P _{IN} | | +20 | dBm |
| Channel temperature | T _{CH} | | 150 | °C |
| Operating temperature | T _A | -55 | +100 | °C |
| Storage temperature | T _{STG} | -65 | +150 | °C |
| Thermal resistance | Θ _{JC} | | 68.8 | °C/W |

Note: Exposure to maximum rating conditions for extended periods may reduce device reliability. There is no damage to device with only one parameter set at the limit and all other parameters set at or below their nominal value. Exceeding any of the limits listed here may result in permanent damage to the device.

CAUTION: Although this device is designed to be as robust as possible, Electrostatic Discharge (ESD) can damage this device. This device must be protected at all times from ESD. Static charges may easily produce potentials of several kilovolts on the human body or equipment, which can discharge without detection. Industry-standard ESD precautions should be used at all times. The SKY67221-11 ESD threshold level is 500 VDC using Human Body Model (HBM) testing (Class 1B), 50 VDC using Man-Machine (MM) model testing (Class A), and 1000 VDC using Charged Device Model (CDM) testing (Class IV).

Table 3. SKY67221-11 Electrical Characteristics (Note 1) (Note 2) (Note 3)

(V_{DD} = V_{BIAS} = 5 V Nominal, I_{DD} = 85 mA, T_A = +25 °C, Characteristic Impedance [Z₀] = 50 Ω, Unless Otherwise Noted)

| Parameter | Symbol | Test Conditions | Minimum | Typical | Maximum | Units |
|--|-----------------|--|---------|---------|---------|-------|
| RF Specifications | | | | | | |
| Noise Figure (Note 4) | NF | @ 1.95 GHz | | 0.9 | 1.2 | dB |
| Small signal gain | IS21I | @ 1.95 GHz | 17.1 | 18.6 | | dB |
| Input return loss | IS11I | @ 1.95 GHz | 15.5 | 27.0 | | dB |
| Output return loss | IS22I | @ 1.95 GHz | 10.5 | 14.5 | | dB |
| Reverse isolation | IS12I | @ 1.95 GHz | 30.5 | 32.5 | | dB |
| 3 rd Order Input Intercept Point | IIP3 | @ 1.95 GHz, Δf = 1 MHz, P _{IN} = -20 dBm/tone | +15.4 | +18.4 | | dBm |
| 3 rd Order Output Intercept Point | OIP3 | @ 1.95 GHz, Δf = 1 MHz, P _{IN} = -20 dBm/tone | +34 | +37 | | dBm |
| Input 1dB Compression Point | IP1dB | @ 1.95 GHz | +1.1 | +3.1 | | dBm |
| Output 1dB Compression Point | OP1dB | @ 1.95 GHz | +18.7 | +20.7 | | dBm |
| Stability (Note 3) | μ1, μ2, K, B | Up to 18 GHz, -40 °C to +85 °C | | >1 | | - |
| DC Specifications | | | | | | |
| Supply voltage | V _{DD} | | | 5 | | V |
| Quiescent current | I _{DD} | R _{BIAS} = 6.8 kΩ | | 85 | | mA |

Note 1: Performance is guaranteed only under the conditions listed in this Table.

Note 2: Circuit topology optimized for best compromise between NF, S₁₁, IIP3, and IP1dB.

Note 3: Applies to typical application circuit and components shown in Figure 26.

Note 4: Loss from input SMA connector and Evaluation Board up to pin 3 of device has been de-embedded (0.04 dB @ 1.95 GHz) from the NF measurement.

Table 4. SKY67221-11 Electrical Characteristics (Note 1) (Note 2) (Note 3)
(V_{DD} = VBIAS = 5 V Nominal, I_{DD} = 105 mA, T_A = +25 °C, Characteristic Impedance [Z₀] = 50 Ω, Unless Otherwise Noted)

| Parameter | Symbol | Test Conditions | Minimum | Typical | Maximum | Units |
|--|-----------------|--|---------|-------------------------|---------|-------------------|
| RF Specifications | | | | | | |
| Noise Figure (Note 4) | NF | @ 1.60 GHz @ 1.95 GHz @ 2.10 GHz | | 0.80 0.91 1.05 | | dB dB dB |
| Small signal gain | IS211 | @ 1.60 GHz @ 1.95 GHz @ 2.10 GHz | | 20.1 19.3 18.4 | | dB dB dB |
| Input return loss | IS111 | @ 1.60 GHz @ 1.95 GHz @ 2.10 GHz | | 10 28 16 | | dB dB dB |
| Output return loss | IS221 | @ 1.60 GHz @ 1.95 GHz @ 2.10 GHz | | 10.5 13.9 12.6 | | dB dB dB |
| Reverse isolation | IS121 | @ 1.60 GHz @ 1.95 GHz @ 2.10 GHz | | 34.0 32.5 33.0 | | dB dB dB |
| 3 rd Order Input Intercept Point | IIP3 | Δf = 1 MHz, P _{IN} = -20 dBm/tone: @ 1.60 GHz @ 1.95 GHz @ 2.10 GHz | | +17.4 +18.7 +19.4 | | dBm dBm dBm |
| 3 rd Order Output Intercept Point | OIP3 | Δf = 1 MHz, P _{IN} = -20 dBm/tone: @ 1.60 GHz @ 1.95 GHz @ 2.10 GHz | | +37.5 +38.0 +37.8 | | dBm dBm dBm |
| Input 1dB Compression Point | IP1dB | @ 1.60 GHz @ 1.95 GHz @ 2.10 GHz | | +2.4 +3.1 +4.4 | | dBm dBm dBm |
| Output 1dB Compression Point | OP1dB | @ 1.60 GHz @ 1.95 GHz @ 2.10 GHz | | +21.5 +21.4 +21.8 | | dBm dBm dBm |
| Stability (Note 3) | μ1, μ2, K, B | Up to 18 GHz, -40 °C to +85 °C | | >1 | | - |
| DC Specifications | | | | | | |
| Supply voltage | V _{DD} | | | 5 | | V |
| Quiescent current | I _{DD} | R _{BIAS} = 6.2 kΩ | | 105 | | mA |

Note 1: Performance is guaranteed only under the conditions listed in this Table.

Note 2: Circuit topology optimized for best compromise between NF, S₁₁, IIP3, and IP1dB.

Note 3: Applies to typical application circuit and components shown in Figure 26.

Note 4: Loss from input SMA connector and Evaluation Board up to pin 3 of device has been de-embedded (0.04 dB @ 1.95 GHz) from the NF measurement.

Table 5. SKY67221-11 Electrical Characteristics (Note 1) (Note 2) (Note 3)
(V_{DD} = V_{BIAS} = 5 V Nominal, I_{DD} = 45 mA, T_A = +25 °C, Characteristic Impedance [Z₀] = 50 Ω, Unless Otherwise Noted)

| Parameter | Symbol | Test Conditions | Minimum | Typical | Maximum | Units |
|--|----------------------|--|---------|-------------------------|---------|-------------------|
| RF Specifications | | | | | | |
| Noise Figure (Note 4) | NF | @ 1.60 GHz @ 1.95 GHz @ 2.10 GHz | | 0.85 0.91 1.02 | | dB dB dB |
| Small signal gain | IS211 | @ 1.60 GHz @ 1.95 GHz @ 2.10 GHz | | 19.0 18.3 17.4 | | dB dB dB |
| Input return loss | IS111 | @ 1.60 GHz @ 1.95 GHz @ 2.10 GHz | | 8 20 13 | | dB dB dB |
| Output return loss | IS221 | @ 1.60 GHz @ 1.95 GHz @ 2.10 GHz | | 10.0 13.0 11.5 | | dB dB dB |
| Reverse isolation | IS121 | @ 1.60 GHz @ 1.95 GHz @ 2.10 GHz | | 34.0 32.5 33.5 | | dB dB dB |
| 3 rd Order Input Intercept Point | IIP3 | $\Delta f = 1$ MHz, P _{IN} = -20 dBm/tone: @ 1.60 GHz @ 1.95 GHz @ 2.10 GHz | | +12.5 +14.4 +15.0 | | dBm dBm dBm |
| 3 rd Order Output Intercept Point | OIP3 | $\Delta f = 1$ MHz, P _{IN} = -20 dBm/tone: @ 1.60 GHz @ 1.95 GHz @ 2.10 GHz | | +31.5 +32.7 +32.4 | | dBm dBm dBm |
| Input 1dB Compression Point | IP1dB | @ 1.60 GHz @ 1.95 GHz @ 2.10 GHz | | +3.0 +3.2 +5.4 | | dBm dBm dBm |
| Output 1dB Compression Point | OP1dB | @ 1.60 GHz @ 1.95 GHz @ 2.10 GHz | | +21.0 +20.5 +21.8 | | dBm dBm dBm |
| Stability (Note 3) | $\mu 1, \mu 2, K, B$ | Up to 18 GHz, -40 °C to +85 °C | | >1 | | - |
| DC Specifications | | | | | | |
| Supply voltage | V _{DD} | | | 5 | | V |
| Quiescent current | I _{DD} | R _{BIAS} = 12 kΩ | | 45 | | mA |

Note 1: Performance is guaranteed only under the conditions listed in this Table.

Note 2: Circuit topology optimized for best compromise between NF, S₁₁, IIP3, and IP1dB.

Note 3: Applies to typical application circuit and components shown in Figure 26.

Note 4: Loss from input SMA connector and Evaluation Board up to pin 3 of device has been de-embedded (0.04 dB @ 1.95 GHz) from the NF measurement.

Typical Performance Characteristics @ I_{DD} = 85 mA

(V_{DD} = VBIAS = 5 V Nominal, T_A = +25 °C, Characteristic Impedance [Z₀] = 50 Ω, Unless Otherwise Noted)

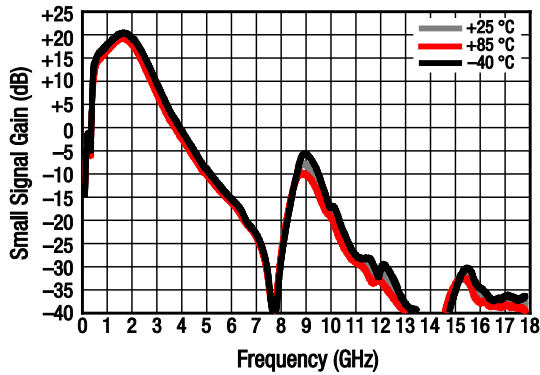

Figure 3. Broadband Gain Response vs Frequency Over Temperature

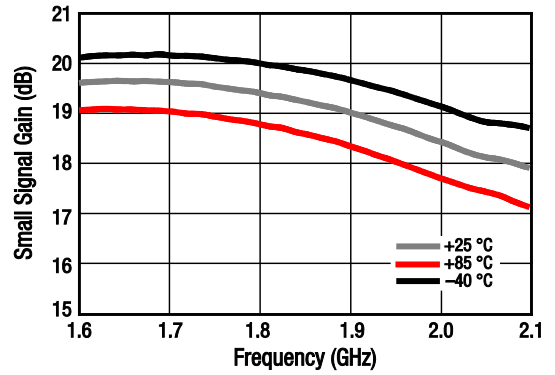

Figure 4. Narrowband Gain Response vs Frequency Over Temperature

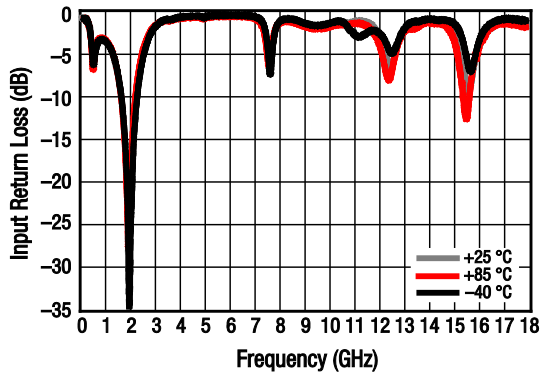

Figure 5. Broadband Input Return Loss vs Frequency Over Temperature

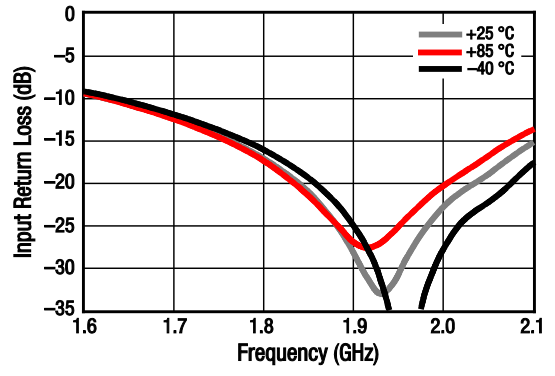

Figure 6. Narrowband Input Return Loss vs Frequency Over Temperature

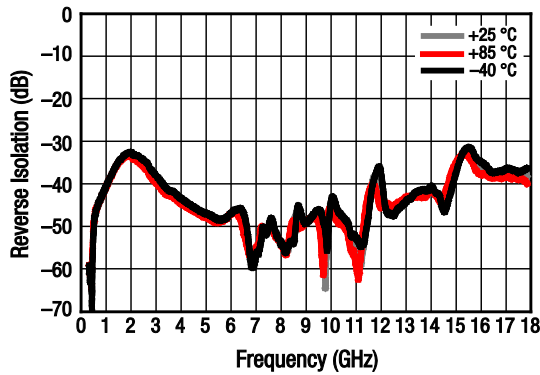

Figure 7. Broadband Reverse Isolation vs Frequency Over Temperature

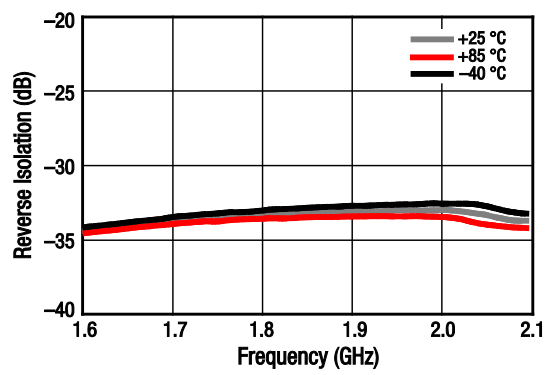

Figure 8. Narrowband Reverse Isolation vs Frequency Over Temperature

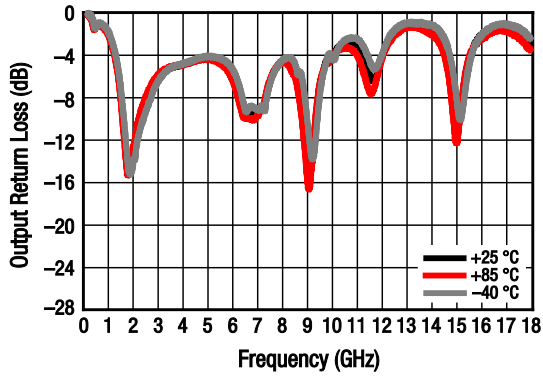

Figure 9. Broadband Output Return Loss vs Frequency Over Temperature

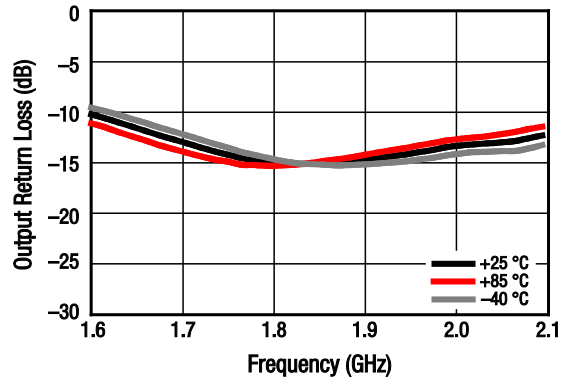

Figure 10. Narrowband Output Return Loss vs Frequency Over Temperature

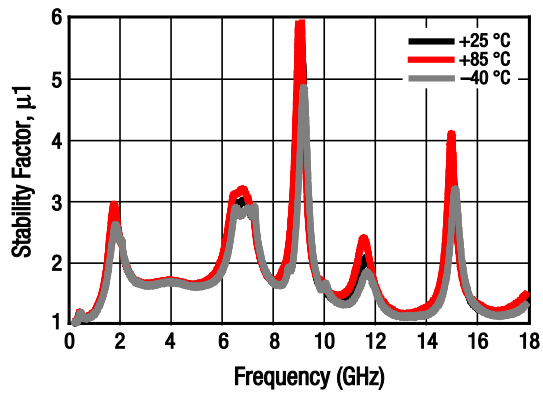

Figure 11. Stability Factor (μ_1) vs Frequency Over Temperature

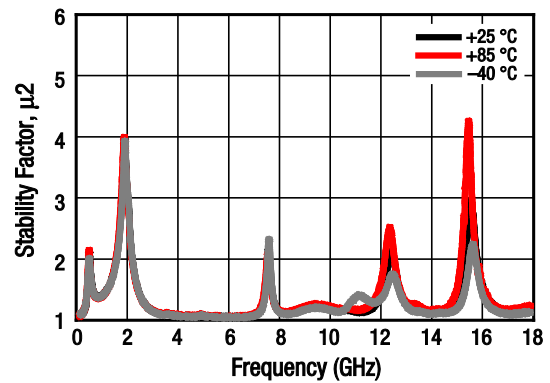

Figure 12. Stability Factor (μ_2) vs Frequency Over Temperature

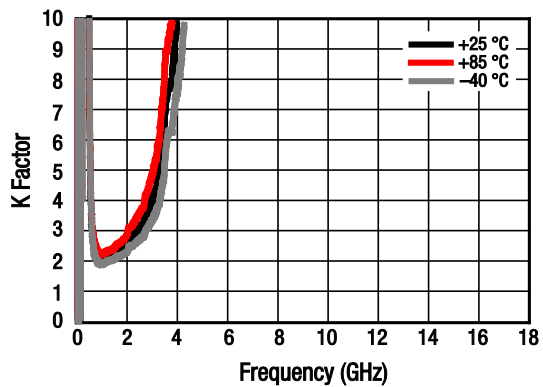

Figure 13. Stability Factor (K) vs Frequency Over Temperature

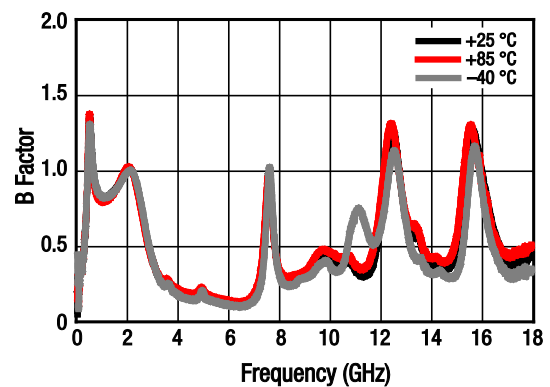

Figure 14. Stability Factor (B) vs Frequency Over Temperature

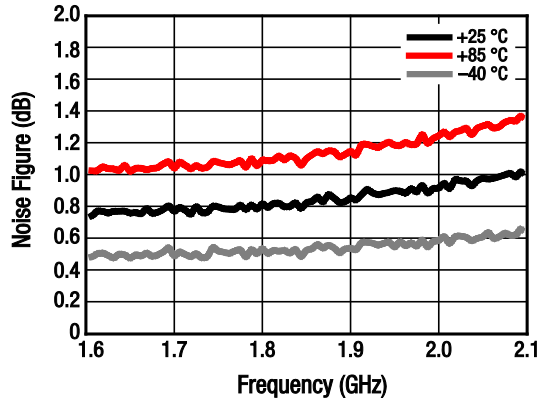

Figure 15. Noise Figure vs Frequency Over Temperature

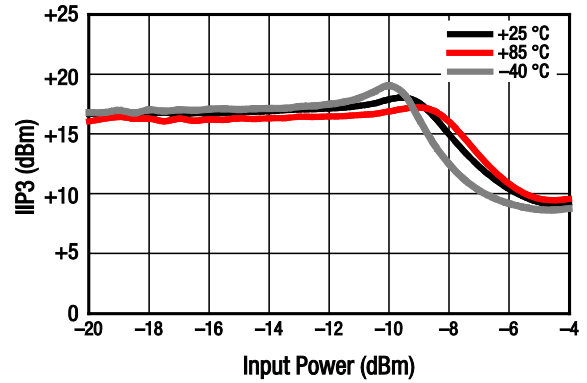

Figure 16. IIP3 vs Input Power Over Temperature @ 1600 MHz (Tone Spacing = 1 MHz)

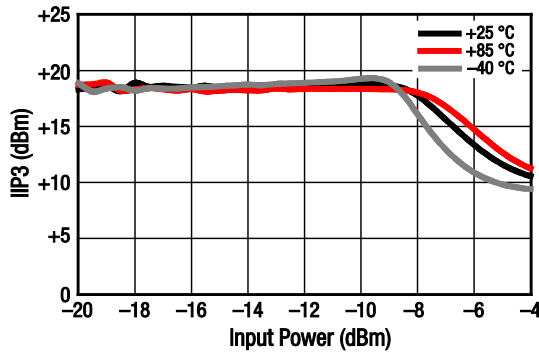

Figure 17. IIP3 vs Input Power Over Temperature @ 1950 MHz (Tone Spacing = 1 MHz)

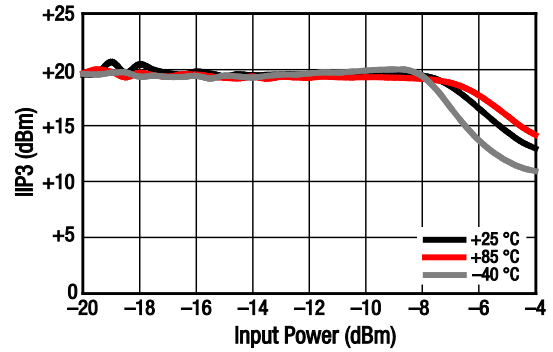

Figure 18. IIP3 vs Input Power Over Temperature @ 2100 MHz (Tone Spacing = 1 MHz)

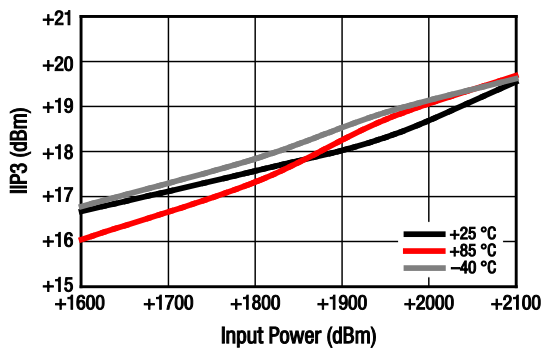

Figure 19. IIP3 vs Frequency Over Temperature (P_{IN} = -20 dBm, Tone Spacing = 1 MHz)

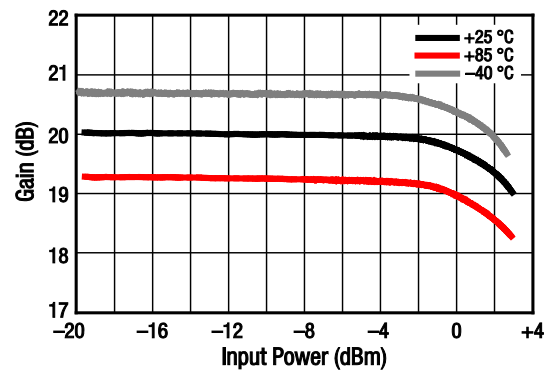

Figure 20. Gain vs Input Power Over Temperature @ 1600 MHz

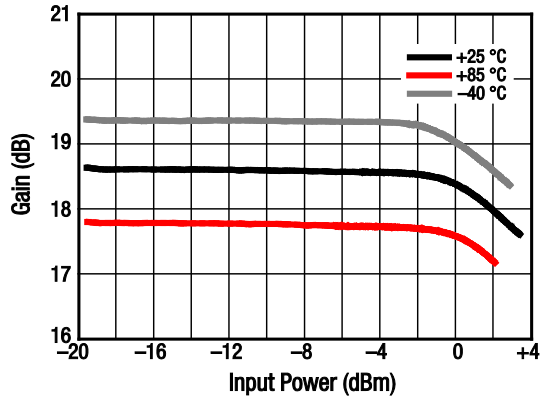

Figure 21. Gain vs Input Power Over Temperature @ 1950 MHz

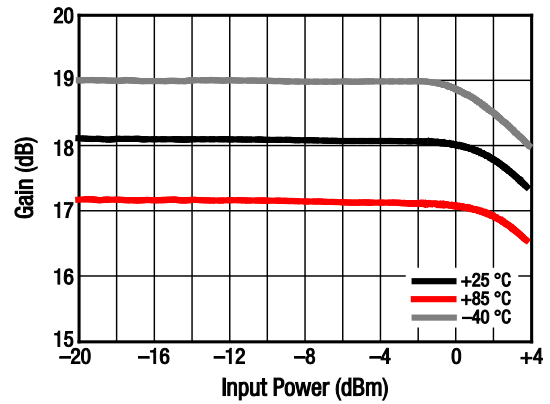

Figure 22. Gain vs Input Power Over Temperature @ 2100 MHz

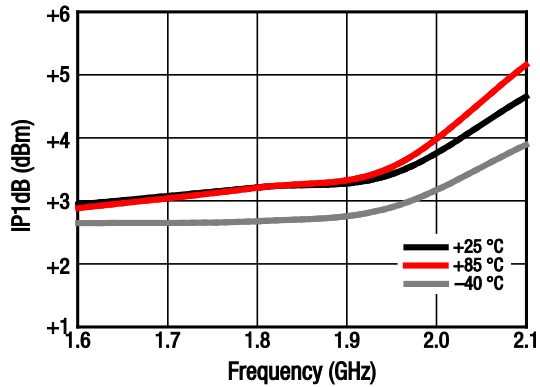

Figure 23. IP1dB vs Frequency Over Temperature

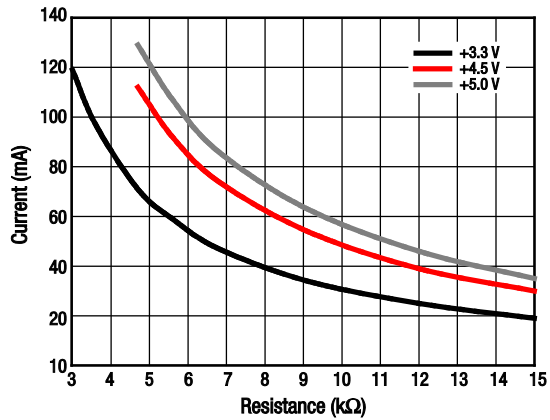

Figure 24. Resistor R1 vs Current Over Voltage

Evaluation Board Description

The SKY67221-11 Evaluation Board is used to test the performance of the SKY67221-11 LNA. The Evaluation Board schematic diagram is shown in Figure 25. An assembly drawing for the Evaluation Board is shown in Figure 26. The layer detail physical characteristics are noted in Figure 27. Table 7 provides the Bill of Materials (BOM) list for Evaluation Board components.

Package Dimensions

The PCB layout footprint for the SKY67221-11 is shown in Figure 28. Typical case markings are shown in Figure 29. Package dimensions for the 16-pin MCM are shown in Figure 30, and tape and reel dimensions are provided in Figure 31.

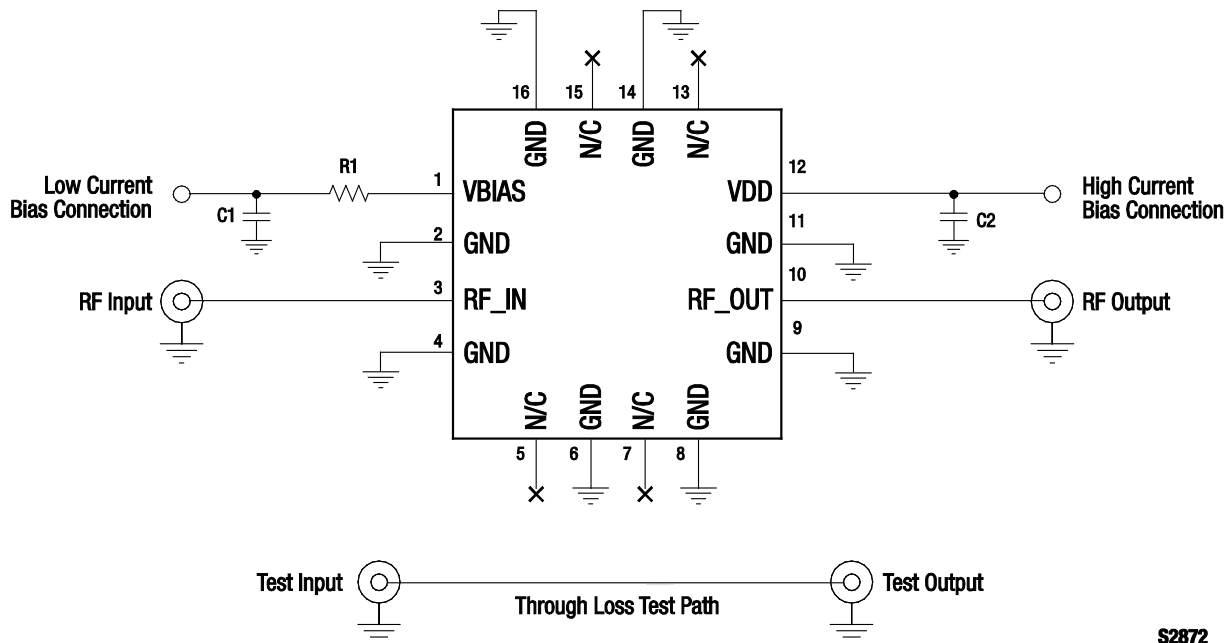

S2872

Figure 25. SKY67221-11 Schematic Diagram

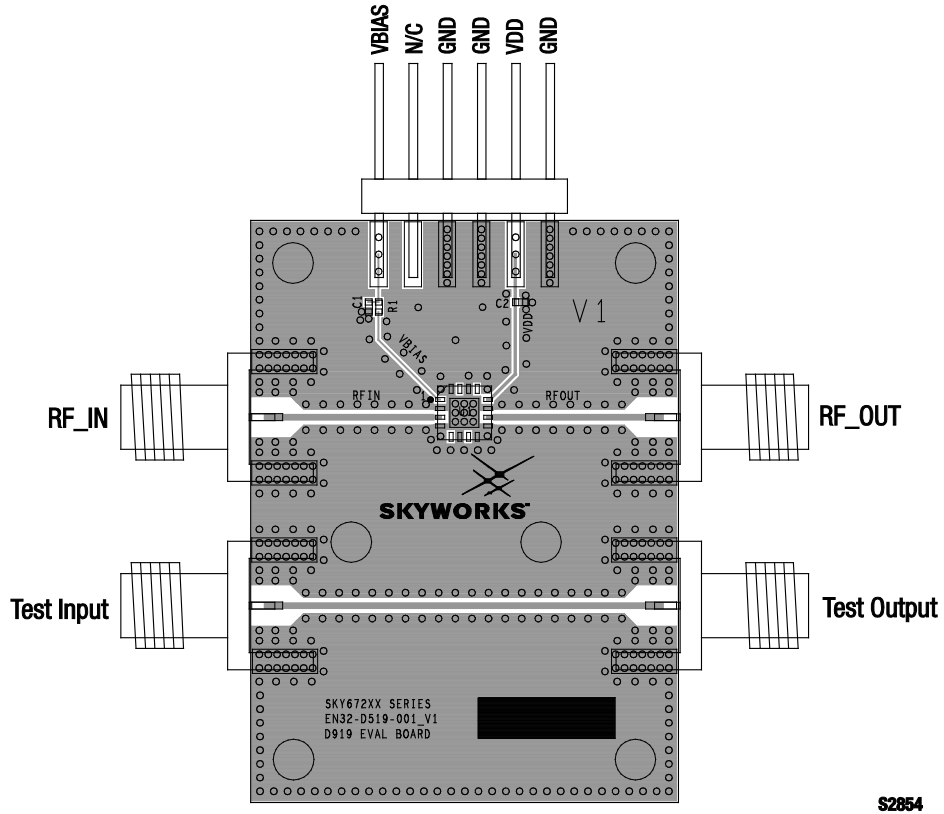
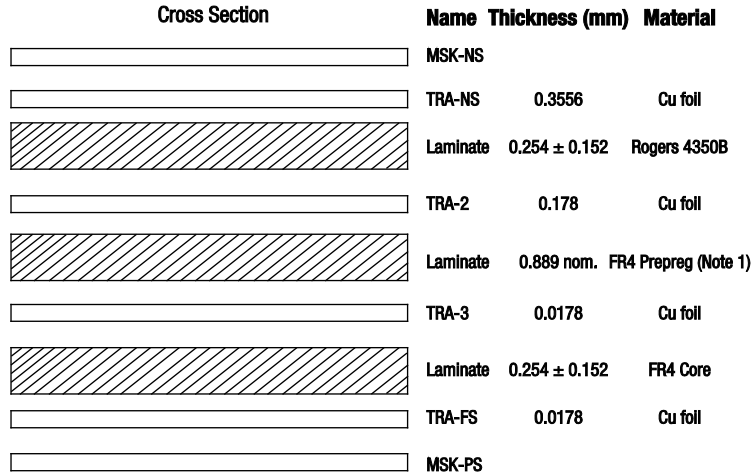

Figure 26. SKY67221-11 Evaluation Board Assembly Drawing



Note 1: Adjust this thickness to meet total thickness goal.

General Notes:
 Material: Rogers R04350, $\epsilon_r = 3.66$
 Layer 1 thickness: 0.254 mm
 Overall board thickness: 1.575 mm
 50 Ω transmission line width: 0.522 mm
 Coplanar ground spacing: 1.575 mm
 Via diameter: 0.254 mm

S2574

Figure 27. Layer Detail Physical Characteristics

Table 6. SKY67221-11 Evaluation Board Bill of Materials

| Component | Size | Value | Vendor | Part Number |
|---------------------------------|------|---------------|-----------|-------------|
| C1 | | DNI | | |
| C2 | | DNI | | |
| R1 for 85 mA operation (Note 1) | 0402 | 6800 Ω | Panasonic | |

Note 1: Placement in relation to component package is not critical.

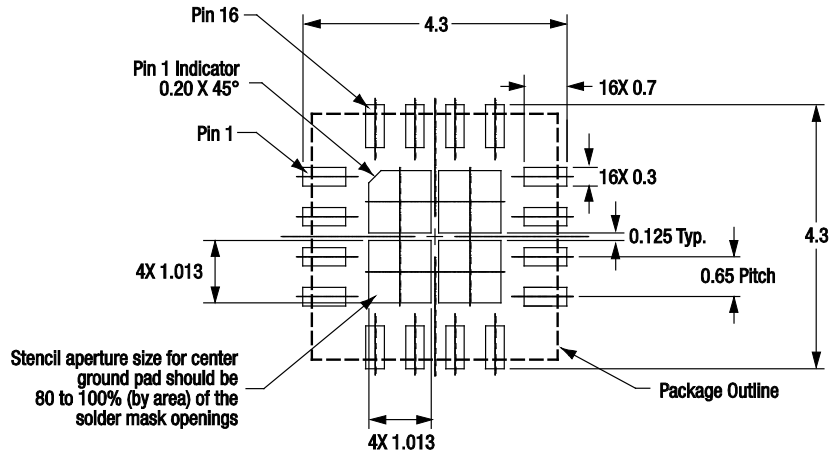

Stencil Aperture Top View

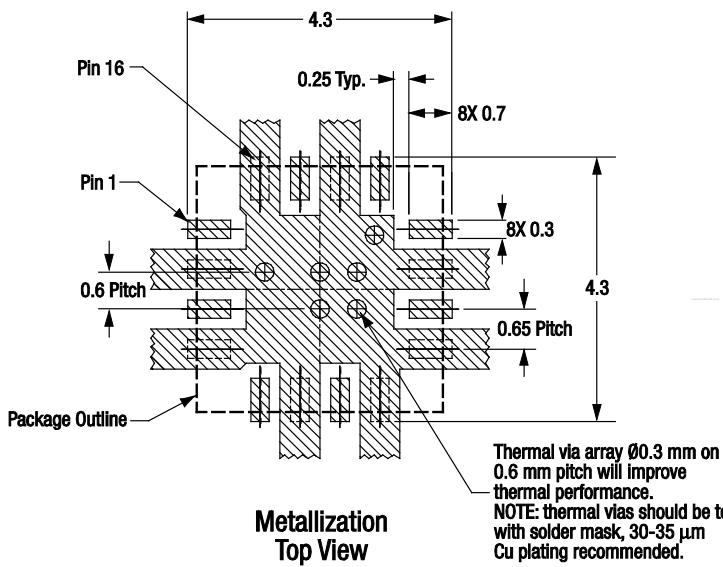

Metallization Top View

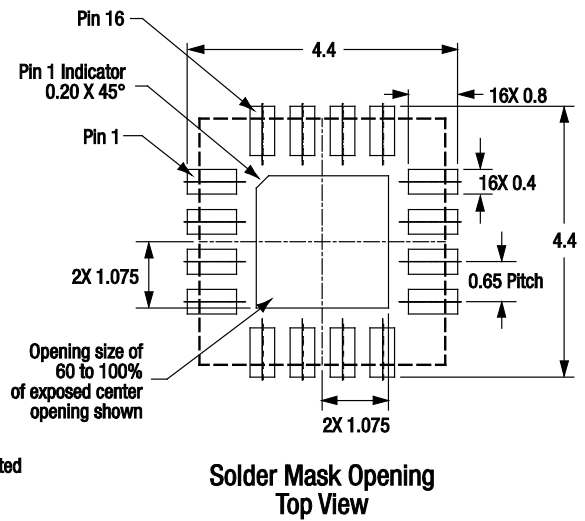

Solder Mask Opening Top View

All dimensions are in millimeters

S2869

Figure 28. SKY67221-11 PCB Layout Footprint

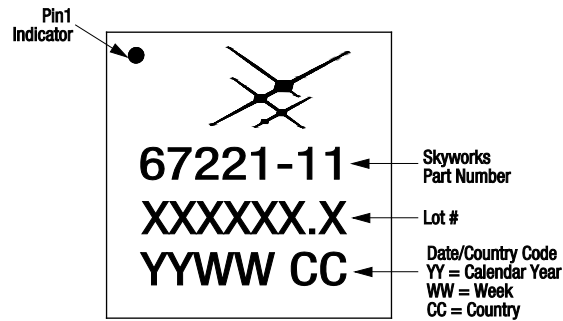
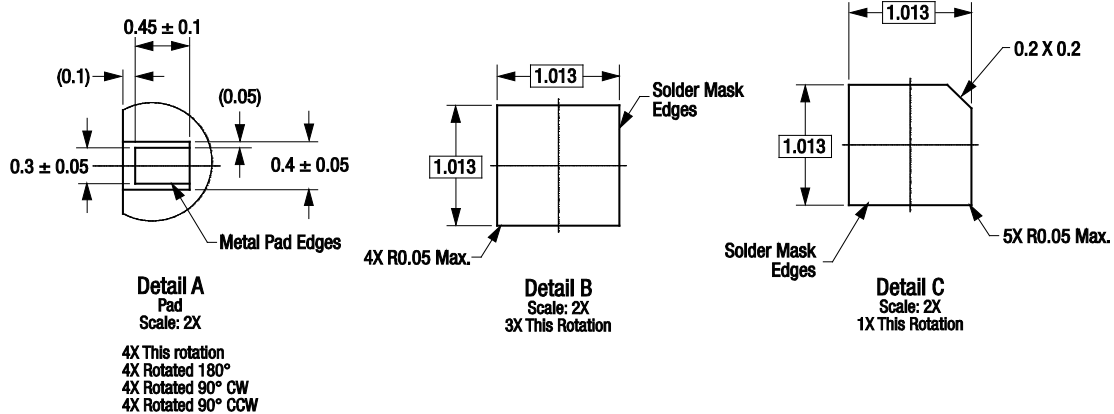
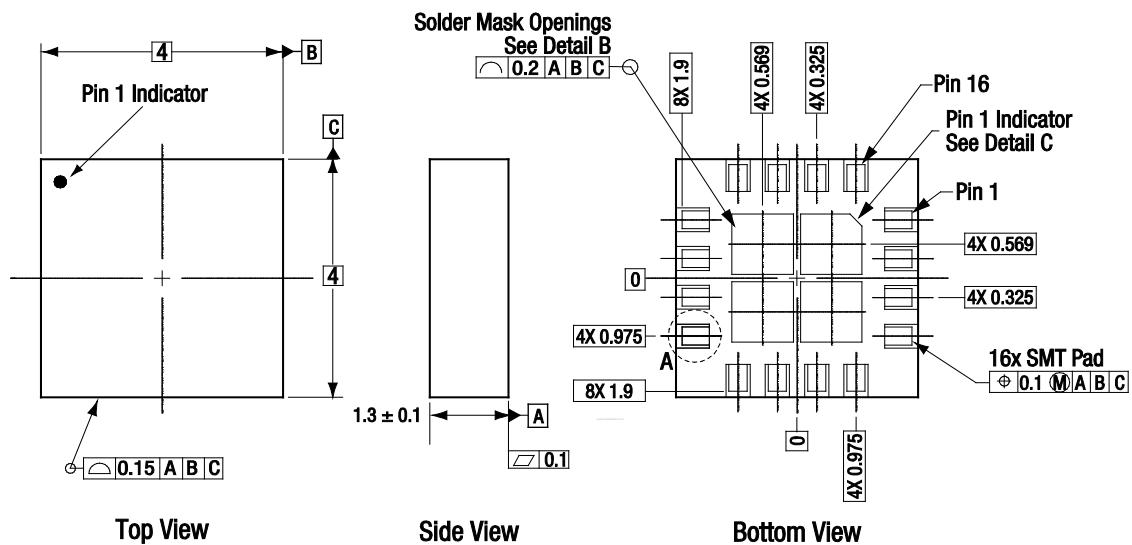

Figure 29. Typical Part Markings (Top View)



All measurements are in millimeters
Dimensioning and tolerancing according to ASME Y14.5M-1994

S2870

Figure 30. SKY67221-11 16-Pin MCM Package Dimensions

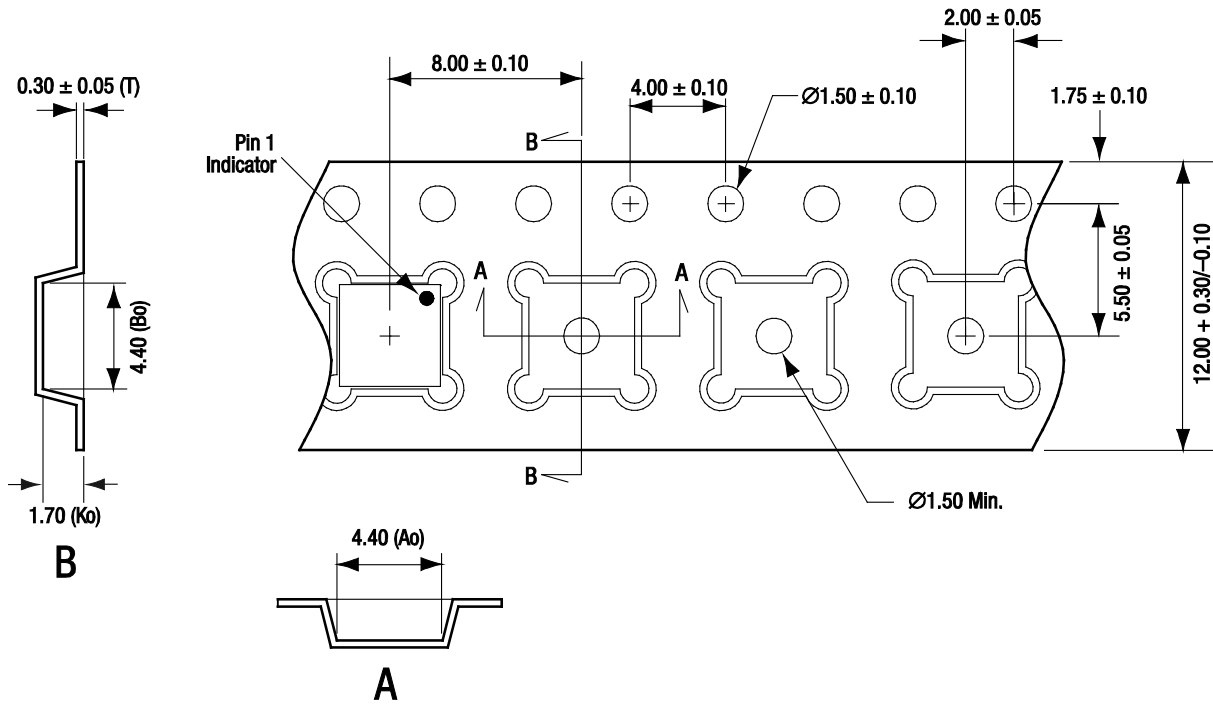

Notes:

1. Carrier tape material: black conductive polycarbonate or polystyrene.
2. Cover tape material: transparent conductive PSA.
3. Cover tape size: 9.3 mm width.
4. Ten sprocket hole pitch cumulative tolerance: ± 0.20 mm.
5. Ao and Bo measured on plane 0.30 mm above the bottom of the pocket.
6. Typical ESD surface resistivity is $\leq 1 \times 10^{10}$ Ohms/square per EIA, JEDEC tape and reel specification.
7. All measurements are in millimeters

S2031

Figure 31. SKY67221-11 Tape and Reel Dimensions

Ordering Information

| Model Name | Manufacturing Part Number | Evaluation Board Part Number |
|------------------------------------|---------------------------|------------------------------|
| SKY67221-11 1.6-2.1 GHz LNA Module | SKY67221-11 | EN32-D519-001_V1 |

Copyright © 2012 Skyworks Solutions, Inc. All Rights Reserved.

Information in this document is provided in connection with Skyworks Solutions, Inc. ("Skyworks") products or services. These materials, including the information contained herein, are provided by Skyworks as a service to its customers and may be used for informational purposes only by the customer. Skyworks assumes no responsibility for errors or omissions in these materials or the information contained herein. Skyworks may change its documentation, products, services, specifications or product descriptions at any time, without notice. Skyworks makes no commitment to update the materials or information and shall have no responsibility whatsoever for conflicts, incompatibilities, or other difficulties arising from any future changes.

No license, whether express, implied, by estoppel or otherwise, is granted to any intellectual property rights by this document. Skyworks assumes no liability for any materials, products or information provided hereunder, including the sale, distribution, reproduction or use of Skyworks products, information or materials, except as may be provided in Skyworks Terms and Conditions of Sale.

THE MATERIALS, PRODUCTS AND INFORMATION ARE PROVIDED "AS IS" WITHOUT WARRANTY OF ANY KIND, WHETHER EXPRESS, IMPLIED, STATUTORY, OR OTHERWISE, INCLUDING FITNESS FOR A PARTICULAR PURPOSE OR USE, MERCHANTABILITY, PERFORMANCE, QUALITY OR NON-INFRINGEMENT OF ANY INTELLECTUAL PROPERTY RIGHT; ALL SUCH WARRANTIES ARE HEREBY EXPRESSLY DISCLAIMED. SKYWORKS DOES NOT WARRANT THE ACCURACY OR COMPLETENESS OF THE INFORMATION, TEXT, GRAPHICS OR OTHER ITEMS CONTAINED WITHIN THESE MATERIALS. SKYWORKS SHALL NOT BE LIABLE FOR ANY DAMAGES, INCLUDING BUT NOT LIMITED TO ANY SPECIAL, INDIRECT, INCIDENTAL, STATUTORY, OR CONSEQUENTIAL DAMAGES, INCLUDING WITHOUT LIMITATION, LOST REVENUES OR LOST PROFITS THAT MAY RESULT FROM THE USE OF THE MATERIALS OR INFORMATION, WHETHER OR NOT THE RECIPIENT OF MATERIALS HAS BEEN ADVISED OF THE POSSIBILITY OF SUCH DAMAGE.

Skyworks products are not intended for use in medical, lifesaving or life-sustaining applications, or other equipment in which the failure of the Skyworks products could lead to personal injury, death, physical or environmental damage. Skyworks customers using or selling Skyworks products for use in such applications do so at their own risk and agree to fully indemnify Skyworks for any damages resulting from such improper use or sale.

Customers are responsible for their products and applications using Skyworks products, which may deviate from published specifications as a result of design defects, errors, or operation of products outside of published parameters or design specifications. Customers should include design and operating safeguards to minimize these and other risks. Skyworks assumes no liability for applications assistance, customer product design, or damage to any equipment resulting from the use of Skyworks products outside of stated published specifications or parameters.

Skyworks, the Skyworks symbol, and "Breakthrough Simplicity" are trademarks or registered trademarks of Skyworks Solutions, Inc., in the United States and other countries. Third-party brands and names are for identification purposes only, and are the property of their respective owners. Additional information, including relevant terms and conditions, posted at www.skyworksinc.com, are incorporated by reference.