

AC Line Filters

AC FILTERS



- All specifications in this catalog and production status of products are subject to change without notice. Prior to the purchase, please contact NEC TOKIN for updated product data.
- Please request for a specification sheet for detailed product data prior to the purchase.
- Before using the product in this catalog, please read "Precautions" and other safety precautions listed in the printed version catalog.

Contents

Earth inductors

SNG series	4
------------------	---

Common mode

SC Coils - Standard Type	6
SC Coils - Terminal Base Type SC-J Type	8
SC Coils - Terminal Base Type SC-GJ Type	10
SC Coils - Terminal Base Type SC-JV Type	11
SC Coils - Terminal Base Type SC-JS Type	12
SC Coils - Terminal Base Type SC-JH Type	13
SC Coils - Small Type SC-G/GS Type	14
SC Coils - Compact, High-Inductance Type, SCF Type	16
SC Coils - High Frequency Type SC-D Type	17
SCR Coils High Impedance Type	18
SU Coils SU 7VC Type	19
SU Coils SU 9V/9H Type	20
SU Coils SU 9VF/9HF Type	22
SU Coils SU 10VFC-R Type	23
SU Coils - High Frequency Type SU 9VD Type	24
SU Coils - High Frequency Type SU 10VD Type	25
SU Coils - High Frequency Type SU 16VD Type	26
SS Coils SS11VL Type	27
SS Coils SS11V/H-CH Type	29
SS Coils SSB11V-R/11H-R Type	31
SS Coils SS17HB Type	32
SS Coils SS17VA/HA Type	35
SS Coils SS20H Type	38
SS Coils SS21V Type	40
SS Coils SS24V/H-CH Type	42
SS Coils SS26V Type	44
SS Coils SS28V/H-CH Type	46
SS Coils SSB28V/H Type	48
SS Coils SS30V Type	49
SS Coils SS35V/35H Type	51
SS Coils SS38V Type	52

Normal mode

SN Coils: Characteristics and Precautions	53
HHB Coils Hi μ and Low Core loss Type	55
SN Coils Small and Standard Type	59
SN Coils Terminal Base Type - J Type	62
SN Coils Terminal Base Type - JA Type	63
SN Coils Terminal Base Type - JB Type	64
SN Coils Terminal Base Type - W Type	65
SN Coils Terminal Base Type - P1 Type	66
SN Coils Terminal Base Type - P2 Type	67

High frequency type

SHB Coils (Booster Coils for Active Filters)	68
Precautions	70



- All specifications in this catalog and production status of products are subject to change without notice. Prior to the purchase, please contact NEC TOKIN for updated product data.
- Please request for a specification sheet for detailed product data prior to the purchase.
- Before using the product in this catalog, please read "Precautions" and other safety precautions listed in the printed version catalog.

AC Line Filters Vol.13



- All specifications in this catalog and production status of products are subject to change without notice. Prior to the purchase, please contact NEC TOKIN for updated product data.
- Please request for a specification sheet for detailed product data prior to the purchase.
- Before using the product in this catalog, please read "Precautions" and other safety precautions listed in the printed version catalog.

SNG Series Earth Inductors

[RoHS Compliant]





Model	Rated voltage (V AC/DC)	Withstanding voltage (V AC)*	Insulation resistance (MΩ)**	Inductance(μH) +50%(160kHz) -30%	DC resistance max.(mΩ)	Operating temperature range(°C)	Recognized by:	Weight approx. (g)
SNG-19A-080	250	2500	≥ 20	80	10	-25~+60	TÜV	19
SNG-19B-080	250	2500	≥ 20	80	10	-25~+60	TÜV	19
SNG-25A-600	250	2500	≥ 20	600	20	-25~+60	TÜV	38
SNG-25B-600	250	2500	≥ 20	600	20	-25~+60	TÜV	38
SNG-19DA-014	250	2500	≥ 20	14	10	-25~+60	—	20
SNG-19DB-014	250	2500	≥ 20	14	10	-25~+60	—	20
SNG-25DA-086	250	2500	≥ 20	86	20	-25~+60	—	38
SNG-25DB-086	250	2500	≥ 20	86	20	-25~+60	—	38

*For one minute between insulating cap and terminal AC
 **For one minute at 500VDC between insulating cap and terminal
 • Thermal class: A (105°C)

Shape and Dimensions

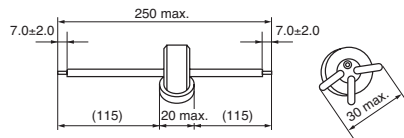
●SNG-19A-080, SNG-19DA-014



●SNG-25A-600, SNG-25DA-086

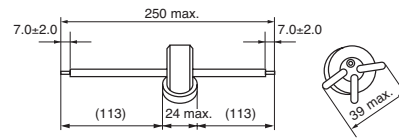

●SNG-19B-080, SNG-19DB-014

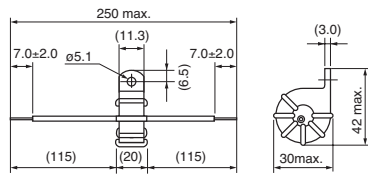

● SNG-25B-600, SNG-25DB-086

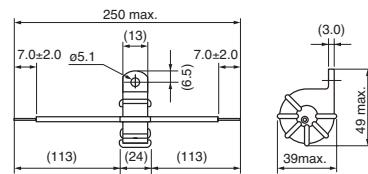

Wiring: AWG 16 UL 1015

[mm]

Applications

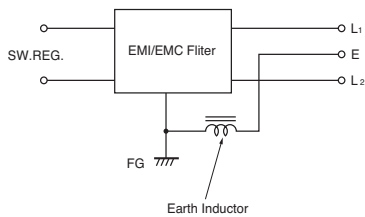

- All specifications in this catalog and production status of products are subject to change without notice. Prior to the purchase, please contact NEC TOKIN for updated product data.
- Please request for a specification sheet for detailed product data prior to the purchase.
- Before using the product in this catalog, please read "Precautions" and other safety precautions listed in the printed version catalog.

Noise Suppression Effect

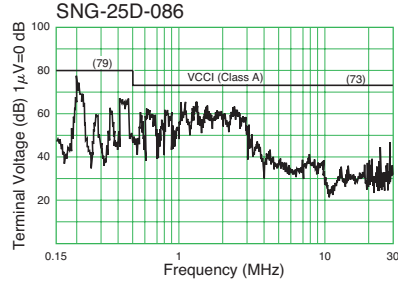
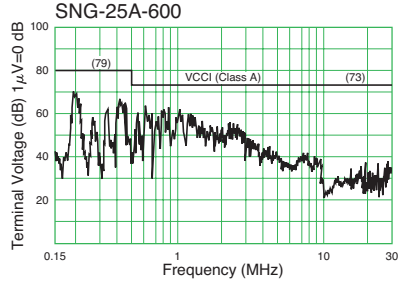
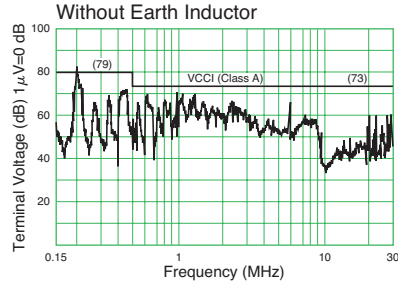
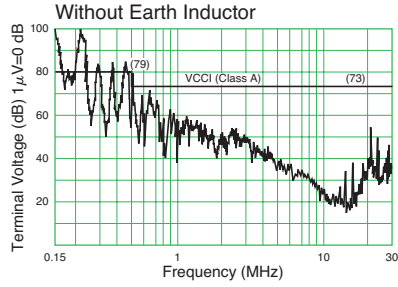

Impedance vs. Frequency

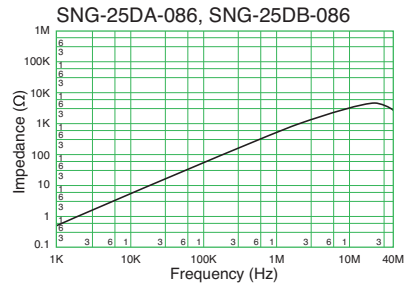
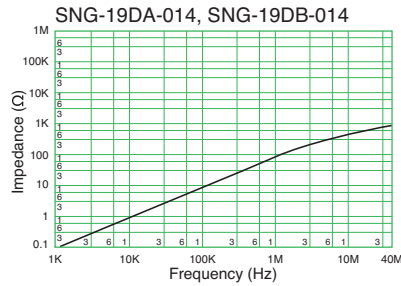
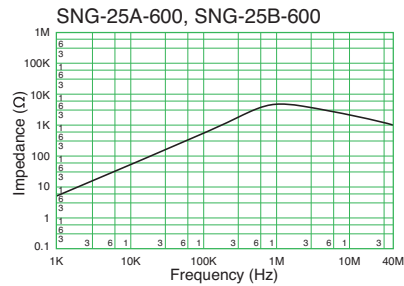
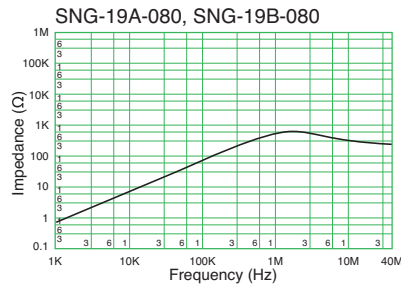

- All specifications in this catalog and production status of products are subject to change without notice. Prior to the purchase, please contact NEC TOKIN for updated product data.
- Please request for a specification sheet for detailed product data prior to the purchase.
- Before using the product in this catalog, please read "Precautions" and other safety precautions listed in the printed version catalog.

SC Coils – Standard Type

[RoHS Compliant]



Model	Rated current (A)	Inductance (mH) min.	DC resistance (mΩ/line) max.	Temperature rise(K) max.	Finished dimensions(mm)		pin pitch (reference)		Wire size (mmφ)	Weight approx. (g)
					OD (max.)	T (max.)	a	b		
SC-02-101	2	1	110	40	23.0	13.0	6	11	0.6	15
SC-02-100	2	1	100	40	23.0	18.5	6	17	0.6	15
SC-02-200	2	2	110	40	23.0	18.5	6	17	0.6	15
SC-02-300	2	3	100	40	27.0	20.0	6	17	0.6	16
SC-02-500	2	5	100	45	27.0	20.0	6	17	0.6	20
SC-02-800	2	8	150	40	34.0	23.0	7	20	0.6	25
SC-05-100	5	1	50	40	25.0	18.5	6	17	0.8	20
SC-05-200	5	2	70	40	32.0	22.0	7	21	0.8	25
SC-05-500	4	5	80	50	34.0	23.0	7	21	0.8	30
SC-05-800	4	8	85	60	34.0	23.0	7	21	0.8	40
SC-10-100	10	1	20	40	34.0	24.0	22	21	1.3	40
SC-10-200	10	2	28	40	47.0	27.0	30	30	1.3	80
SC-15-100	15	1	12	40	49.0	27.0	35	35	1.8	100
SC-15-200	15	2	12	45	50.0	28.0	35	35	1.8	110
SC-20-100	20	1	8	45	60.0	30.0	40	40	2.3	135
SC-30-100	30	1	6	40	62.0	35.0	55	20	2.6	190

- Rated voltage: 250VAC/VDC • Withstanding voltage: AC2400V (2sec. between lines)
- Insulation resistance: at 500VDC, more than 100MΩ (between lines) • Thermal class: A (105°C)
- Operating temperature range (°C): -25 to T (T=105=temperature rise) • Pin pitch listed above are reference only. not guaranteed values.
- Inductance measurement condition:100kHz, 1mA, KC547

Shape and Dimensions

● SC Coils vertical type (~5A)

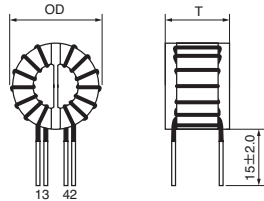

● SC Coils horizontal type (10A~)

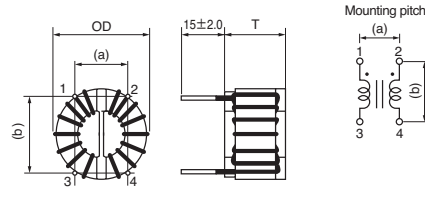

[mm]



- All specifications in this catalog and production status of products are subject to change without notice. Prior to the purchase, please contact NEC TOKIN for updated product data.
- Please request for a specification sheet for detailed product data prior to the purchase.
- Before using the product in this catalog, please read "Precautions" and other safety precautions listed in the printed version catalog.

Attenuation (Static Characteristics) and Circuit Diagram

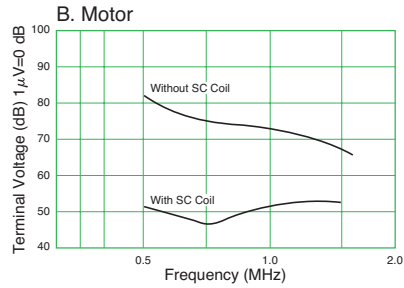
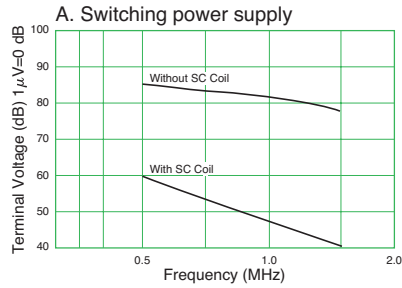

●Circuit

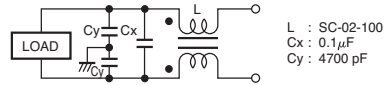

●Circuit

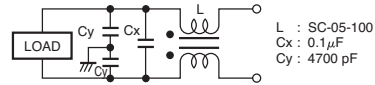

Frequency characteristic

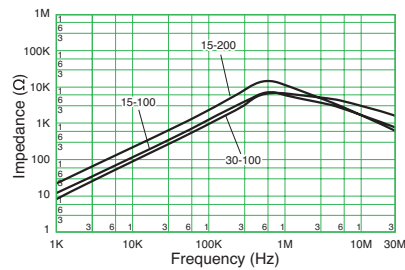
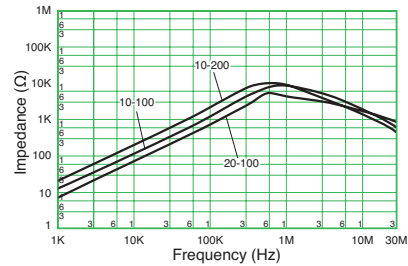
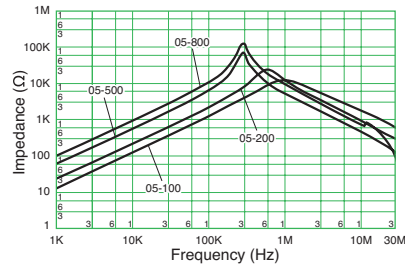
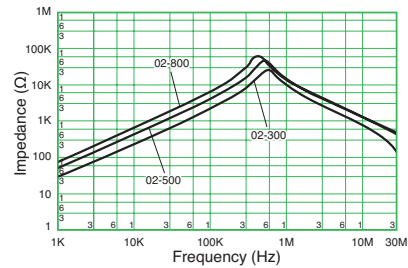
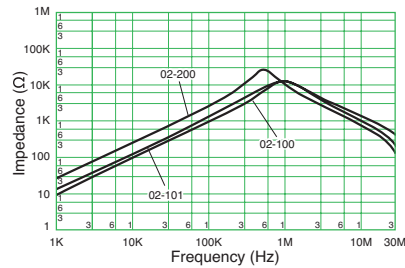

- All specifications in this catalog and production status of products are subject to change without notice. Prior to the purchase, please contact NEC TOKIN for updated product data.
- Please request for a specification sheet for detailed product data prior to the purchase.
- Before using the product in this catalog, please read "Precautions" and other safety precautions listed in the printed version catalog.

SC Coils – Terminal Base Type

SC-J Type

[RoHS Compliant]



Model	Rated current (A)	Inductance (mH) min.	DC resistance (mΩ/line) max.	Temperature rise(K) max.	Finished dimensions(mm)					Wire size (mmφ)	Weight approx. (g)
					OD(max.)	T(max.)	H(max.)	a	b		
SC-02-10J ※	2	1	100	40	25	20	27	10	15	0.6	15
SC-02-20J ※	2	2	110	40	25	20	27	10	15	0.6	15
SC-02-30J ※	2	3	110	40	25	20	27	10	15	0.6	16
SC-02-50J ※	2	5	120	40	25	20	27	10	15	0.6	20
SC-05-10J ※	5	1	50	40	25	20	27	10	15	0.8	20
SC-05-20J ※	5	2	70	40	34	23	33	18	16	0.8	25
SC-05-30J ※	5	3	70	55	34	23	33	18	16	0.8	30
SC-05-50J ※	4	5	80	60	34	23	33	18	16	0.8	32
SC-05-80J ※	4	8	90	60	34	23	33	18	16	0.8	42
SC-10-10J	10	1	20	40	34	23	33	12	17	1.3	42
SC-10-20J	10	2	22	50	42	29	44	18	22	1.4	70
SC-10-30J ※	10	3	30	75	34	24	33	18	16	1.2	65
SC-12-15J	12	1.5	18	50	42	29	44	18	22	1.5	70
SC-15-05J ※	15	0.5	8	60	34	23	33	18	16	1.5	40
SC-15-10J	15	1	12	55	44	30	44	18	22	1.7	75
SC-18-05J	18	0.5	7	50	44	30	44	18	22	1.8	60

- Rated voltage: 250VAC/VDC • Withstanding voltage: AC 2400V (2 sec between lines)
- Insulation resistance: at 500VDC, more than 100MΩ (between lines) • Thermal class: A (105°C) or *E (120°C)
- Operating temperature range (°C): -25 to T (T=105-temperature rise *T=120-temperature rise)
- Inductance measurement condition:100kHz, 1mA, KC547

Shape and Dimensions

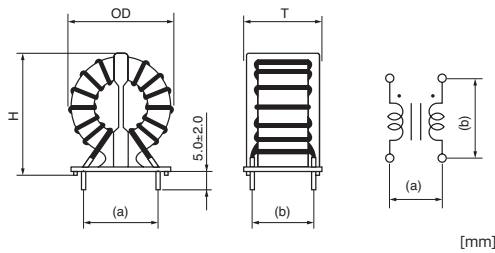

Frequency characteristic

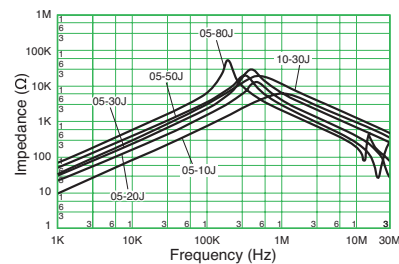
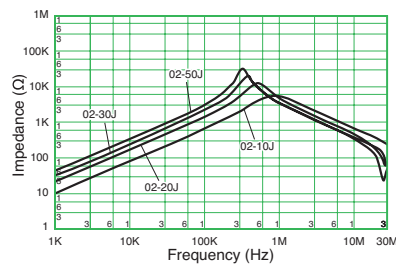

- All specifications in this catalog and production status of products are subject to change without notice. Prior to the purchase, please contact NEC TOKIN for updated product data.
- Please request for a specification sheet for detailed product data prior to the purchase.
- Before using the product in this catalog, please read "Precautions" and other safety precautions listed in the printed version catalog.

Frequency characteristic

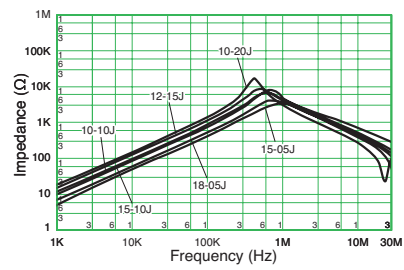

- All specifications in this catalog and production status of products are subject to change without notice. Prior to the purchase, please contact NEC TOKIN for updated product data.
- Please request for a specification sheet for detailed product data prior to the purchase.
- Before using the product in this catalog, please read "Precautions" and other safety precautions listed in the printed version catalog.

SC Coils – Terminal Base Type SC-GJ Type

[RoHS Compliant]



Model	Rated current (A)	Inductance (mH) min.	DC resistance (mΩ/line) max.	Temperature rise(K) max.	Wire size (mmφ)	Marking	Weight approx. (g)
SC-02-20GJ	2	2.0	80	40	0.5	220	9
SC-02-30GJ	2	3.0	100	40	0.5	230	10
SC-03-06GJ	3	0.6	35	40	0.6	306	8
SC-03-10GJ	3	1.0	40	40	0.6	310	9

- Rated voltage: 250VAC/VDC • Withstanding voltage: AC 2400V (2 sec between lines)
- Insulation resistance: at 500VDC, more than 100MΩ(between lines) • Thermal class: E (120°C)
- Operating temperature range (°C): -25 to T (T=120-temperature rise)
- Inductance measurement condition:100kHz, 1mA, KC547

Shape and Dimensions

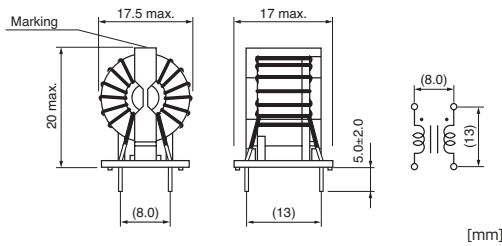

Frequency characteristic

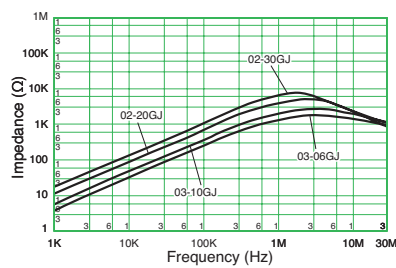

- All specifications in this catalog and production status of products are subject to change without notice. Prior to the purchase, please contact NEC TOKIN for updated product data.
- Please request for a specification sheet for detailed product data prior to the purchase.
- Before using the product in this catalog, please read "Precautions" and other safety precautions listed in the printed version catalog.

SC Coils – Terminal Base Type SC-JV Type

[RoHS Compliant]



Model	Rated current (A)	Inductance (mH) min.	DC resistance (mΩ/line) max.	Temperature rise(K) max.	Wire size (mmφ)	Recognized by:	Weight approx. (g)
SC-02-300JV	2	44+50%, -30%	300	45	0.6	VDE	45
SC-04-200JV	4	29+50%, -30%	150	55	0.8	VDE	45
SC-05-100JV	5	15+50%, -30%	100	55	0.9	VDE	45

- Rated voltage: 250VAC/VDC • Withstanding voltage: 2400V (2 sec between lines)
- Insulation resistance: at 500VDC, more than 50MΩ (between lines, from line to tube) • Thermal class: A (105°C)
- Operating temperature range (°C): -25 to T (T=105-temperature rise)
- Inductance measurement condition: 16kHz, 0.2mA, KC547

Shape and Dimensions

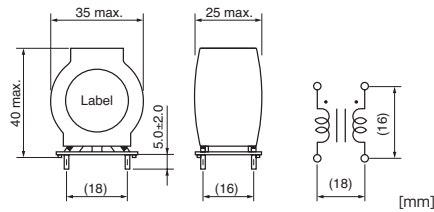

Frequency characteristic

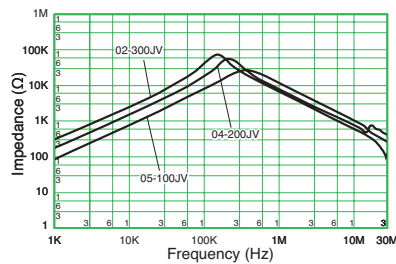

- All specifications in this catalog and production status of products are subject to change without notice. Prior to the purchase, please contact NEC TOKIN for updated product data.
- Please request for a specification sheet for detailed product data prior to the purchase.
- Before using the product in this catalog, please read "Precautions" and other safety precautions listed in the printed version catalog.

SC Coils – Terminal Base Type SC-JS Type

[RoHS Compliant]



Model	Rated current (A)	Inductance (mH) min.	DC resistance (mΩ/line) max.	Temperature rise(K) max.	Wire size (mmφ)	Weight approx. (g)
SC-02-10JS	2	1.0	100	40	0.5	8.0
SC-02-15JS	2	1.5	120	40	0.5	8.5
SC-02-20JS	2	2.0	120	40	0.5	9.0
SC-03-08JS	3	0.8	60	40	0.6	9.0
SC-03-10JS	3	1.0	80	40	0.6	9.0

- Rated voltage: 250VAC/VDC • Withstanding voltage: AC 2400V (2 sec between lines)
- Insulation resistance: at 500VDC, more than 100MΩ (between lines, from line to tube) • Thermal class: A (105°C)
- Operating temperature range (°C):-25 to T (T=105-temperature rise)
- Inductance measurement condition:1kHz, 0.3mA, KC547

Shape and Dimensions

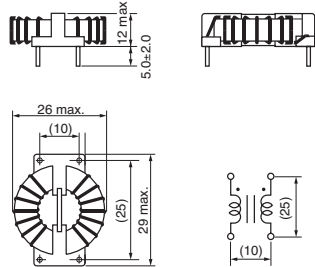

[mm]

Frequency characteristic

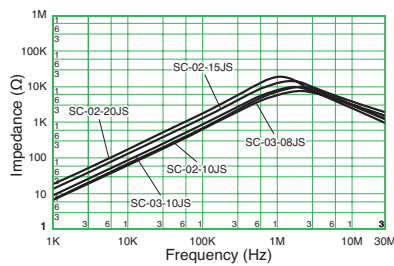

- All specifications in this catalog and production status of products are subject to change without notice. Prior to the purchase, please contact NEC TOKIN for updated product data.
- Please request for a specification sheet for detailed product data prior to the purchase.
- Before using the product in this catalog, please read "Precautions" and other safety precautions listed in the printed version catalog.

SC Coils – Terminal Base Type

SC-JH Type

[RoHS Compliant]



Model	Rated current (A)	Inductance (mH) min.	DC resistance (mΩ/line) max.	Temperature rise(K) max.	Finished dimensions(mm)					Wire size (mmφ)	Weight approx. (g)
					OD(max.)	T(max.)	H(max.)	a	b		
SC-10-20JH	10	2.0	22	45	42	30	41	17	30	1.4	72
SC-12-15JH	12	1.5	18	45	42	30	41	17	30	1.5	71
SC-15-10JH	15	1.0	12	50	44	32	41	17	30	1.7	73
SC-15-20JH	15	2.0	12	45	51	34	—	26	30	1.8	115
SC-18-15JH	18	1.5	10	55	51	34	—	26	30	1.9	117
SC-20-10JH	20	1.0	8	50	51	34	—	15	35	2.0	110

- Rated voltage: 250VAC/VDC • Withstanding voltage: 2400V (2 sec between lines)
- Insulation resistance: at 500VDC, more than 100MΩ(between lines) • Thermal class: A (105°C)
- Operating temperature range (°C): -25 to T (T=105-temperature rise) • Inductance measurement condition:100kHz, 1mA, KC547

Shape and Dimensions

●SC-15-20JH, SC-18-15JH, SC-20-10JH

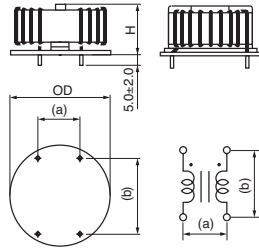

●SC-10-20JH, SC-12-15JH, SC-15-10JH

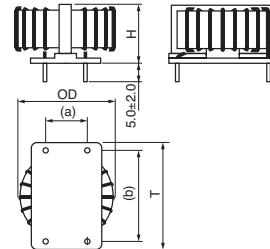

[mm]

Frequency characteristic

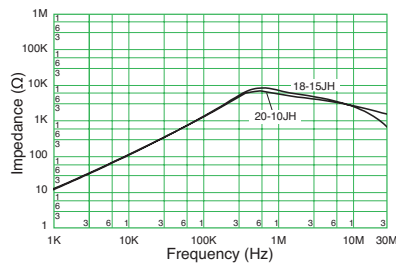
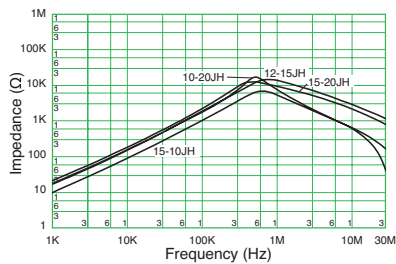

- All specifications in this catalog and production status of products are subject to change without notice. Prior to the purchase, please contact NEC TOKIN for updated product data.
- Please request for a specification sheet for detailed product data prior to the purchase.
- Before using the product in this catalog, please read "Precautions" and other safety precautions listed in the printed version catalog.

SC Coils – Small Type

SC-G/GS Type

[RoHS Compliant]



Model	Rated current (A)	Inductance (mH) min.	DC resistance (mΩ/line) max.	Temperature rise(K) max.	Wire size (mmφ)	Marking	Weight approx. (g)
SC-01-06G	1	0.6	60	40	0.4	106	5
SC-01-10G	1	1.0	70	40	0.4	110	5
SC-01-20G	1	2.0	100	40	0.4	120	5
SC-01-30G	1	3.0	120	40	0.4	130	6
SC-01-50G	1	5.0	150	40	0.4	150	7
SC-01-80G	1	8.0	300	40	0.35	180	6
SC-01-E100G ※	1	10.0	350	40	0.35	100	6
SC-01-E121G ※	1	12.0	400	40	0.35	121	6
SC-01-E150G ※	1	15.0	450	40	0.35	—	6
SC-02-06G	2	0.6	50	40	0.5	206	6
SC-02-10G	2	1.0	50	40	0.5	210	7
SC-02-20G	2	2.0	70	40	0.5	220	8
SC-02-30G	2	3.0	85	40	0.5	230	9
SC-03-06G	3	0.6	30	40	0.6	306	7
SC-03-10G	3	1.0	35	40	0.6	310	8
SC-01-10GS	1	1.0	130	40	0.3	—	2
SC-01-20GS	1	2.0	180	40	0.3	—	2
SC-02-10GS	2	1.0	80	40	0.4	—	3
SC-03-05GS	3	0.5	45	45	0.45	—	3

- Rated voltage: 250VAC/VDC • Withstanding voltage: AC 2400V (2 sec between lines)
- Insulation resistance: at 500VDC, more than 100MΩ (between lines) • Thermal class: A (105°C) or *E (120°C)
- Operating temperature range (°C): -25 to T (T=105-temperature rise *T=120-temperature rise)
- Inductance measurement condition: 100kHz, 1mA, KC547 (*=1mA, KC547)

Shape and Dimensions

●SC-G

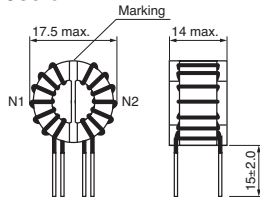

●SC-GS

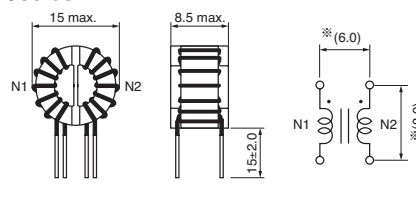

※Pin pitch are for reference only. Not guaranteed values. [mm]



- All specifications in this catalog and production status of products are subject to change without notice. Prior to the purchase, please contact NEC TOKIN for updated product data.
- Please request for a specification sheet for detailed product data prior to the purchase.
- Before using the product in this catalog, please read "Precautions" and other safety precautions listed in the printed version catalog.

Frequency characteristic

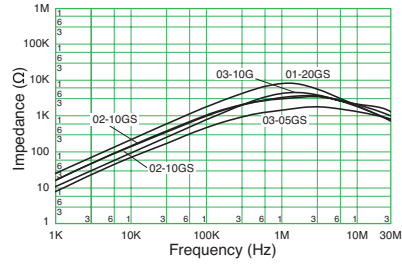
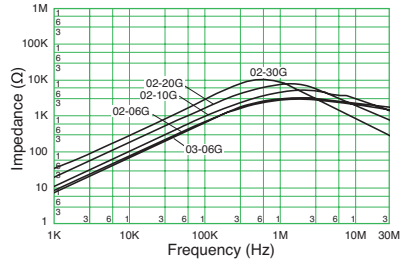
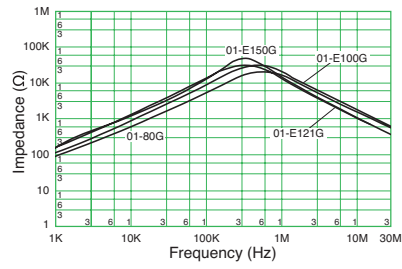
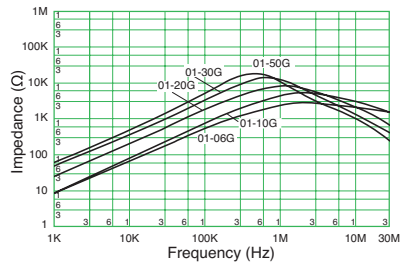

- All specifications in this catalog and production status of products are subject to change without notice. Prior to the purchase, please contact NEC TOKIN for updated product data.
- Please request for a specification sheet for detailed product data prior to the purchase.
- Before using the product in this catalog, please read "Precautions" and other safety precautions listed in the printed version catalog.

SC Coils – Compact, High-Inductance Type SCF Type

[RoHS Compliant]



Model	Rated current (A)	Wire size (mmφ)	Inductance (mH) min.	DC resistance (mΩ/line) max.	Temperature rise(K) max.	Finished dimensions (mm)			Weight approx. (g)	pin pitch (reference)	
						A (max.)	B (max.)	C		a	b
SCF-01-5000※	1.0	0.35	50.0	390.0	60	15.0	12.0	15±2.0	5.0	—	—
SCF-02-1300※	2.0	0.45	13.0	115.0	50	15.0	12.0	15±2.0	5.0	—	—
SCF-03-650※	3.0	0.50	6.5	70.0	55	15.0	12.0	15±2.0	5.0	5	9
SCF-05-350※	5.0	0.60	3.5	35.0	55	16.0	12.0	15±2.0	5.0	5	9
SCF20-05-550	5.0	0.80	5.5	28.0	50	25.0	15.5	20±2.5	11.4	14	12
SCF20-05-1100	5.0	0.80	11.0	39.0	70	25.0	15.5	20±2.5	13.5	14	12
SCF25-06-2000	6.0	1.10	2.0	26.0	45	32.0	23.0	10±2.5	41.5	13	20
SCF25-08-1300	8.0	1.20	13.0	18.0	50	32.0	23.0	10±2.5	41.0	13	20
SCF27-10-1300	10.0	1.30	13.0	15.0	55	35.0	24.0	15±3.0	47.0	24	20
SCF27-15-700	15.0	1.50	7.0	5.0	70	36.0	24.0	15±3.0	48.0	24	20

- Rated voltage: 250VAC/VDC (Models with ※ have insulation distance designed value of equal or greater than 2.6mm)
- Withstanding voltage: AC 2400V (2 sec between lines) • Operating temperature range (°C): -25 to T (T=120-temperature rise)
- Thermal class: E (120°C) • Inductance measurement condition: 10kHz, 1mA, KC547
- Pin pitch are reference only. Not guaranteed values.

Shape and Dimensions

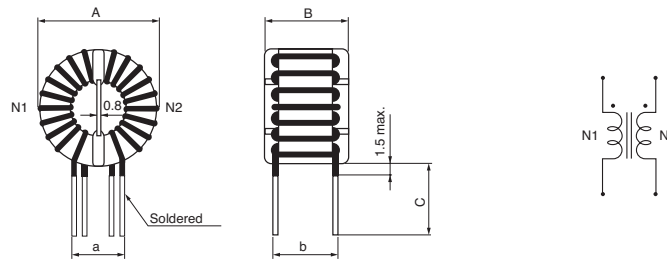

[mm]

Frequency characteristic

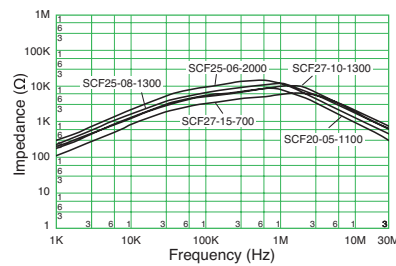
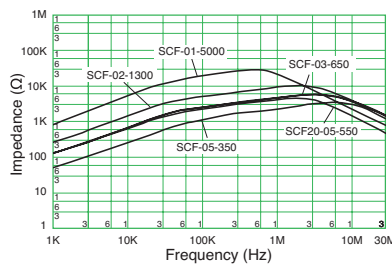

- All specifications in this catalog and production status of products are subject to change without notice. Prior to the purchase, please contact NEC TOKIN for updated product data.
- Please request for a specification sheet for detailed product data prior to the purchase.
- Before using the product in this catalog, please read "Precautions" and other safety precautions listed in the printed version catalog.

SC Coils – High Frequency Type

SC-D Type

[RoHS Compliant]



Model	Rated current (A)	Inductance (μH) min.	DC resistance (mΩ/line) max.	Temperature rise(K) max.	Finished dimensions(mm)		pin pitch (reference)		Wire size (mmφ)	Weight approx. (g)
					OD(max.)	T(max.)	a	b		
SC-02-D100	2	100	70	40	23	13	10	13	0.5	7
SC-03-D050	3	50	40	40	23	13	10	13	0.6	8
SC-04-D050	4	50	25	40	25	19	10	19	0.7	14
SC-05-D030	5	30	20	40	25	19	10	19	0.8	14
SC-08-D060	8	60	30	45	34	23	22	21	1.0	30
SC-10-D050	10	50	16	45	34	23	22	21	1.2	34
SC-15-D030	15	30	12	50	34	23	22	21	1.4	34
SC-20-D010	20	10	8	50	34	23	22	21	1.7	33

- Rated voltage: 250VAC/VDC • Withstanding voltage: 2400V (2 sec between lines)
- Insulation resistance: at 500VDC, more than 100MΩ (between lines) • Thermal class: A (105°C)
- Operating temperature range (°C): -25 to T (T=105-temperature rise) • Inductance measurement condition: 100kHz, 1mA, KC547
- Pin pitch are reference only. Not guaranteed values.

Shape and Dimensions

●SC-D vertical type (2A to 5A)

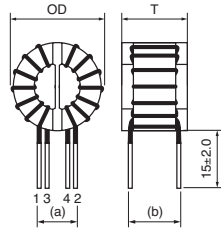

●SC-D horizontal type (8A to 20A)

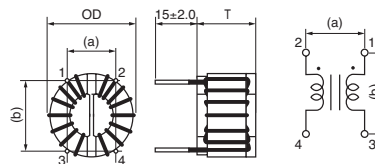

[mm]

Numbering System

SC - 02 - D 100
 ① ② ③

- ① 1 Rated current (A)
- ② Ni-Zn ferrite core
- ③ Inductance (μH)

Frequency characteristic

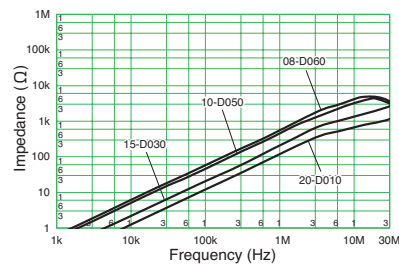
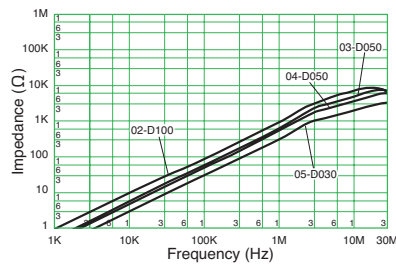

- All specifications in this catalog and production status of products are subject to change without notice. Prior to the purchase, please contact NEC TOKIN for updated product data.
- Please request for a specification sheet for detailed product data prior to the purchase.
- Before using the product in this catalog, please read "Precautions" and other safety precautions listed in the printed version catalog.

SCR Coils High Impedance Type [RoHS Compliant]



Features

- High impedance achieved by using a newly developed core with high permeability
- 30% reduction in volume while maintaining the same properties (Enables saving space/reduction of part count)

Applications

- Audio-visual equipment
- Consumer electronics
- Power supply devices

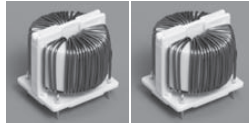

Conventional model with the same shape x2
(core O.D. 19mm)

Reduction of part count



SCR Coil x1
(core O.D. 19mm)

Down of size



Conventional model with the same properties x1
(core O.D. 25mm)

Model	Rated current AC(A)	Inductance (mH) min.	DC resistance (mΩ/line) max.	Temperature rise (K) max.	Wire size (mm φ)	Weight approx. (g)
SCR-020-0R55A250J/JH	2	25	200	55	0.55	22.8
SCR-030-0R6A170J/JH	3	15	145	75	0.60	22.0
SCR-040-0R8A100J/JH	4	10	65	62	0.80	26.2
SCR-050-0R9A070J/JH	5	7	47	70	0.90	27.0

- ※Model names ending with 'J': Vertical terminal type Model names ending with 'JH': Horizontal terminal type
- Rated voltage: 250VAC/VDC ● Withstanding voltage: 2400VAC (2sec. between lines)
 - Insulation resistance: at 500VDC, more than 100MΩ (between lines) ● Thermal class: E (120°C)
 - Operating temperature range (°C): -25 to T (T=120-temperature rise) ● Inductance measurement condition: 10kHz, 1mA

Shape and Dimensions

●SCR-J

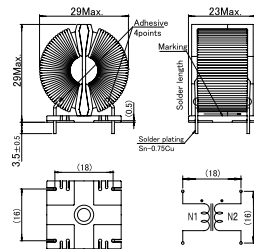

●SCR-JH

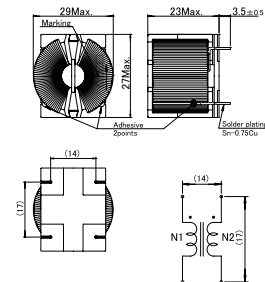

[mm]

Frequency characteristic

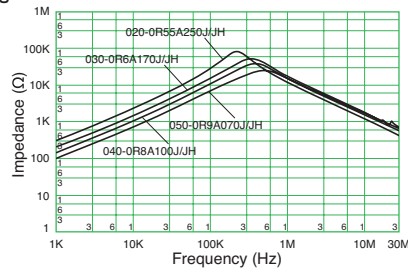

AC Line Filters



- All specifications in this catalog and production status of products are subject to change without notice. Prior to the purchase, please contact NEC TOKIN for updated product data.
- Please request for a specification sheet for detailed product data prior to the purchase.
- Before using the product in this catalog, please read "Precautions" and other safety precautions listed in the printed version catalog.

SU Coils

SU 7VC Type

[RoHS Compliant]



Model	Rated current (A)	Inductance (mH) min.	DC resistance (Ω /line) max.	Temperature rise(K) max.	Marking	Weight approx. (g)
SU7VC-02120	0.2	12.0	6.5	55	02 lot No.	1.7
SU7VC-05011	0.5	1.1	0.84	45	05 lot No.	1.6
SU7VC-07006	0.7	0.60	0.36	45	07 lot No.	1.7
SU7VC-08004	0.8	0.35	0.22	45	08 lot No.	1.7
SU7VC-10003	1.0	0.30	0.20	50	10 lot No.	1.7
SU7VC-12002	1.2	0.25	0.16	55	12 lot No.	1.7

- Rated voltage: 125VAC • Withstanding voltage: 2400V (2 sec between lines)
- Insulation resistance: at 500VDC, more than 100M Ω (between lines) • Thermal class: E (120°C)
- Operating temperature range (°C): -25 to T (T=120-temperature rise) • Inductance measurement condition: 1kHz, 1V, KC530

Shape and Dimensions

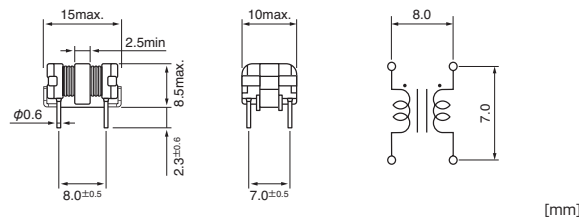

Frequency characteristic

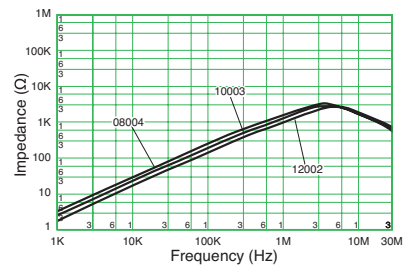
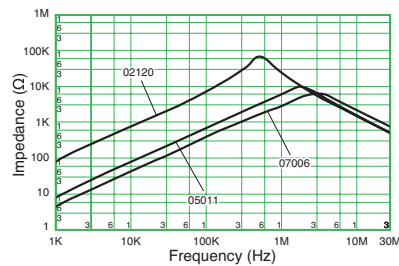

- All specifications in this catalog and production status of products are subject to change without notice. Prior to the purchase, please contact NEC TOKIN for updated product data.
- Please request for a specification sheet for detailed product data prior to the purchase.
- Before using the product in this catalog, please read "Precautions" and other safety precautions listed in the printed version catalog.

SU Coils

SU 9V/9H Type

[RoHS Compliant]



Model	Rated current (A)	Inductance (mH) min.	DC resistance (Ω/line) max.	Temperature rise(K) max.	Marking	Weight approx. (g)
SU9V/H-01100	0.1	10	8.0	40	01100	3.0
SU9V/H-02080	0.2	8.0	6.0	40	02080	3.2
SU9V/H-03050	0.3	5.0	3.0	40	03050	3.4
SU9V/H-05020	0.5	2.0	1.0	40	05020	3.5
SU9V/H-07010	0.7	1.0	0.6	40	07010	3.5
SU9V/H-10005	1.0	0.5	0.3	40	10005	3.4
SU9V/H-R01180	0.1	18	8.0	40	R 01180	3.0
SU9V/H-R02140	0.2	14	6.0	40	R 02140	3.2
SU9V/H-R03090	0.3	9.0	3.0	40	R 03090	3.4
SU9V/H-R05034	0.5	3.4	1.0	40	R 05034	3.5
SU9V/H-R07017	0.7	1.7	0.6	40	R 07017	3.5
SU9V/H-R10008	1.0	0.8	0.3	40	R 10008	3.4

- Rated voltage: 250VAC • Withstanding voltage: AC 2400V (2 sec between lines)
- Insulation resistance: at 500VDC, more than 100MΩ (between lines) • Thermal class: E (120°C)
- Operating temperature range (°C): -25 to T (T=120-temperature rise) • Inductance measurement condition: 1kHz, 1V, KC530

Shape and Dimensions

●SU9V

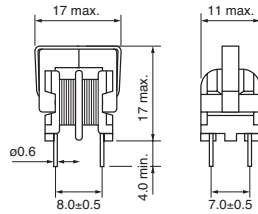

●SU9H

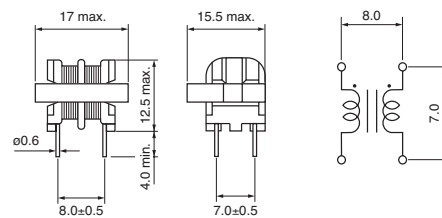

Numbering System

SU 9 V - _ 01 100
 ① ② ③ ④ ⑤ ⑥

- ① Series
- ② Core size
- ③ Core Type (V : vertical type, H : horizontal type)
- ④ Core Type (R : high permeability core)
- ⑤ Current rating (01 shows 0.1A)
- ⑥ Inductance (100 shows 10mH)



- All specifications in this catalog and production status of products are subject to change without notice. Prior to the purchase, please contact NEC TOKIN for updated product data.
- Please request for a specification sheet for detailed product data prior to the purchase.
- Before using the product in this catalog, please read "Precautions" and other safety precautions listed in the printed version catalog.

Frequency characteristic

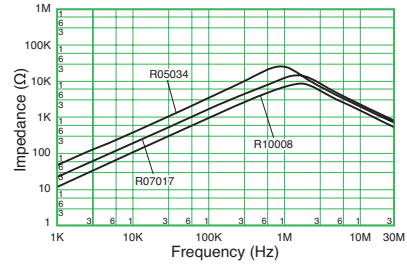
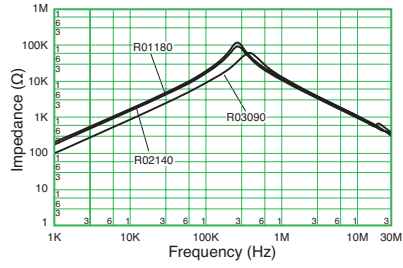
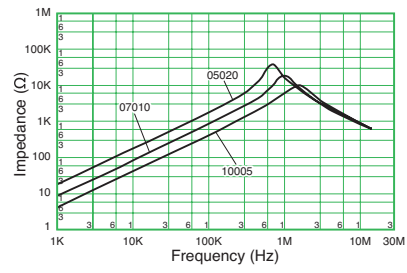
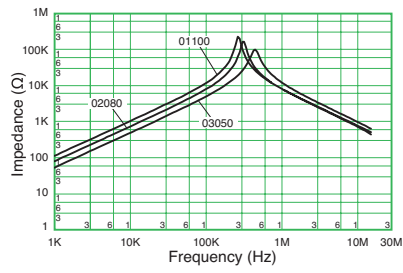

- All specifications in this catalog and production status of products are subject to change without notice. Prior to the purchase, please contact NEC TOKIN for updated product data.
- Please request for a specification sheet for detailed product data prior to the purchase.
- Before using the product in this catalog, please read "Precautions" and other safety precautions listed in the printed version catalog.

SU Coils

SU 9VF/9HF Type

[RoHS Compliant]



Model	Rated current (A)	Inductance (mH) min.	DC resistance (Ω/line) max.	Temperature rise(K) max.	Marking	Weight approx. (g)
SU9VF/HF-02100	0.2	10	4.0	40	02100	3.1
SU9VF/HF-03060	0.3	6	2.0	40	03060	3.2
SU9VF/HF-05030	0.5	3	1.0	45	05030	3.2
SU9VF/HF-07015	0.7	1.5	0.44	40	07015	3.3

- Rated voltage: 250VAC
- Withstanding voltage: AC 2400V (2sec between lines)
- Insulation resistance: at 500VDC, more than 100MΩ (between lines)
- Thermal class: E (120°C)
- Operating temperature range (°C): -25 to T (T=120-temperature rise)
- Inductance measurement condition: 1kHz, 1V, KC530

Shape and Dimensions

●SU9VF

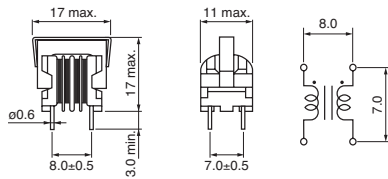

●SU9HF

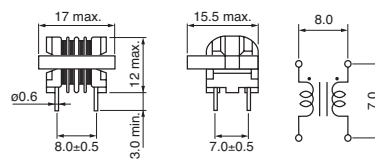

[mm]

Numbering System

SU 9 VF - 02 100

① ② ③ ④ ⑤

- ① Series
- ② Core size
- ③ Type (VF: vertical, HF: horizontal)
- ④ Rated current (02 stands for 0.2A)
- ⑤ Inductance (100 stands for 10mH)

Frequency characteristic

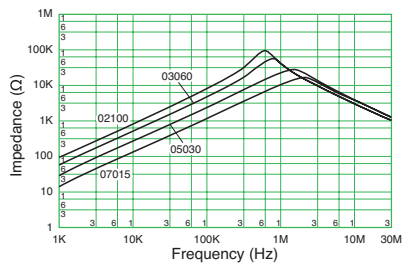

- All specifications in this catalog and production status of products are subject to change without notice. Prior to the purchase, please contact NEC TOKIN for updated product data.
- Please request for a specification sheet for detailed product data prior to the purchase.
- Before using the product in this catalog, please read "Precautions" and other safety precautions listed in the printed version catalog.

SU Coils

SU 10VFC-R Type

[RoHS Compliant]



- <Features> · Super low profile : 15.0mm max
 · High permeability core realizes high inductance
 · Best suites for internal power supply of compact / thin adaptor and other thin - cased devices.

Model	Rated current (A)	Inductance (mH) min.	DC resistance (Ω/line) max.	Temperature rise(K) max.	Marking	Weight approx. (g)
SU10VFC-R03370	0.3	37.0	4.2	45	R03 lot No.	6.5
SU10VFC-R04250	0.4	25.0	2.8	45	R04 lot No.	6.5
SU10VFC-R05140	0.5	14.0	1.6	45	R05 lot No.	6.4
SU10VFC-R07088	0.7	8.8	1.1	50	R07 lot No.	6.3
SU10VFC-R10045	1.0	4.5	0.55	50	R10 lot No.	6.4
SU10VFC-R13025	1.3	2.5	0.30	50	R13 lot No.	6.6
SU10VFC-R15019	1.5	1.9	0.24	50	R15 lot No.	6.5
SU10VFC-R17016	1.7	1.6	0.21	55	R17 lot No.	6.2
SU10VFC-R20010	2.0	1.0	0.15	55	R20 lot No.	6.2

- Rated voltage: 250VAC
- Withstanding voltage: AC 2400V (2 sec between lines)
- Insulation resistance: at 500VDC, more than 100MΩ (between lines)
- Thermal class: E (120°C)
- Operating temperature range (°C): -25 to T (T=200-temperature rise)
- Inductance measurement condition: 1kHz, 1V, KC530

Shape and Dimensions

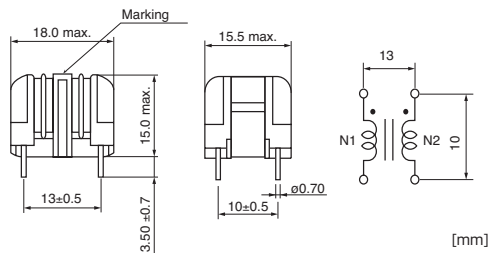

Numbering System

SU 10VFC - R 03 370

- ① ② ③ ④ ⑤

- ① Series
- ② Core size ; shape (V : vertical)
- ③ Core Type (R : High permeability core)
- ④ Rated current (03 stands for 0.3A)
- ⑤ Inductance (370 stands for 37.0mH)

Frequency characteristic

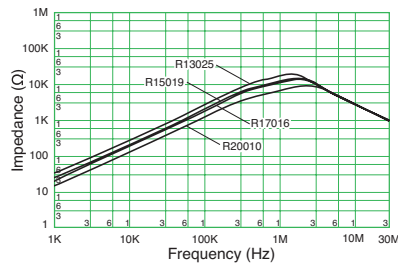
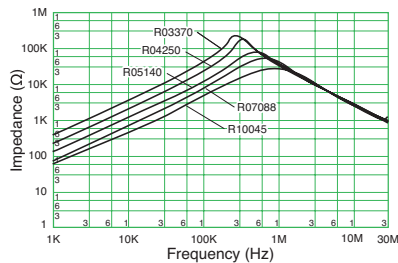

- All specifications in this catalog and production status of products are subject to change without notice. Prior to the purchase, please contact NEC TOKIN for updated product data.
- Please request for a specification sheet for detailed product data prior to the purchase.
- Before using the product in this catalog, please read "Precautions" and other safety precautions listed in the printed version catalog.

SU Coils – High Frequency Type

SU 9VD Type

[RoHS Compliant]



Model	Rated current (A)	Inductance (μH) min.	DC resistance (Ω/line) max.	Temperature rise(K) max.	Marking	Weight approx. (g)
SU9VD-07040	0.7	40	0.18	45	D07040	2.9
SU9VD-07030	0.7	30	0.15	45	D07030	2.9
SU9VD-07020	0.7	20	0.12	45	D07020	2.8
SU9VD-07010	0.7	10	0.10	45	D07010	2.7

- Rated voltage: 250VAC • Withstanding voltage: AC 2400V (2sec between lines)
- Insulation resistance: at 500VDC, more than 100MΩ (between lines) • Thermal class: E (120°C)
- Operating temperature range (°C): -25 to T (T=120-temperature rise) • Inductance measurement condition: 1kHz, 1V, KC530

Shape and Dimensions

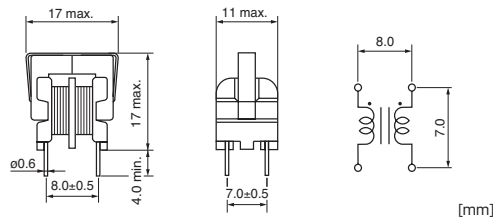

Numbering System

U 9V D - 07 040

- ① ② ③ ④ ⑤

- ① Series
- ② Core size; shape (V: vertical)
- ③ Ni-Zn ferrite core
- ④ Rated current (07 stands for 0.7A)
- ⑤ Inductance (040 stands for 40μH)

Frequency characteristic

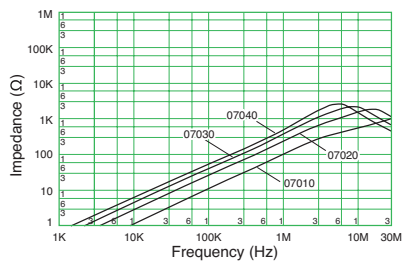

- All specifications in this catalog and production status of products are subject to change without notice. Prior to the purchase, please contact NEC TOKIN for updated product data.
- Please request for a specification sheet for detailed product data prior to the purchase.
- Before using the product in this catalog, please read "Precautions" and other safety precautions listed in the printed version catalog.

SU Coils – High Frequency Type

SU 10VD Type

[RoHS Compliant]

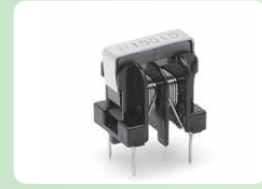

Model	Rated current (A)	Inductance (μH) min.	DC resistance (Ω/line) max.	Temperature rise(K) max.	Marking	Weight approx. (g)
SU10VD-10080	1	80	0.20	45	D10080	5.6
SU10VD-10050	1	50	0.20	45	D10050	5.5
SU10VD-10020	1	20	0.12	45	D10020	5.5
SU10VD-10010	1	10	0.10	45	D10010	5.7
SU10VD-20010	2	10	0.10	45	D20010	5.4

- Rated voltage: 250VAC • Withstanding voltage: AC 2400V (2 sec between lines)
- Insulation resistance: at 500VDC, more than 100MΩ (between lines) • Thermal class: E (120°C)
- Operating temperature range (°C): -25 to T (T=120-temperature rise) • Inductance measurement condition:1kHz, 1V, KC530

Shape and Dimensions

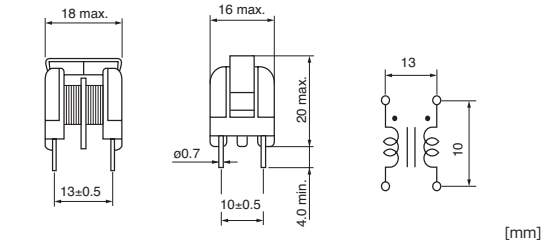

Numbering System

SU 10V D - 10 010

- ① ② ③ ④ ⑤

- ① Series
- ② Core size; shape (V: vertical)
- ③ Ni-Zn ferrite core
- ④ Rated current (10 stands for 1.0A)
- ⑤ Inductance (010 stands for 10μH)

Frequency characteristic

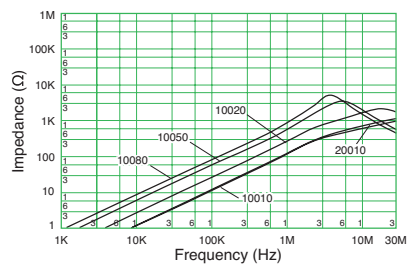

- All specifications in this catalog and production status of products are subject to change without notice. Prior to the purchase, please contact NEC TOKIN for updated product data.
- Please request for a specification sheet for detailed product data prior to the purchase.
- Before using the product in this catalog, please read "Precautions" and other safety precautions listed in the printed version catalog.

SU Coils – High Frequency Type SU 16VD Type

[RoHS Compliant]

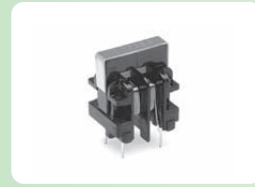

Model	Rated current (A)	Inductance (μH) min.	DC resistance (Ω/line) max.	Temperature rise(K) max.	Marking	Weight approx. (g)
SU16VD-30050	3.0	50	0.08	45	D30050	12.0
SU16VD-30040	3.0	40	0.07	45	D30040	11.9
SU16VD-30030	3.0	30	0.07	45	D30030	11.9
SU16VD-40020	4.0	20	0.05	45	D40020	11.8
SU16VD-40010	4.0	10	0.04	45	D40010	11.6

- Rated voltage: 250VAC • Withstanding voltage: AC 2400V (2sec between lines)
- Insulation resistance: at 500VDC, more than 100MΩ (between lines) • Thermal class: E (120°C)
- Operating temperature range (°C): -25 to T (T=120-temperature rise) • Inductance measurement condition: 1kHz, 1V, KC530

Shape and Dimensions

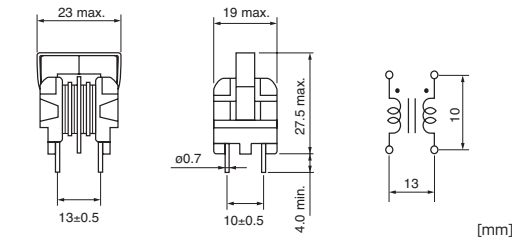

Numbering System

SU 16V D - 30 050

- ① ② ③ ④ ⑤

- ① Series
- ② Core size; shape (V: vertical)
- ③ Ni-Zn ferrite core
- ④ Rated current (30 stands for 3.0A)
- ⑤ Inductance (050 stands for 50μH)

Frequency characteristic

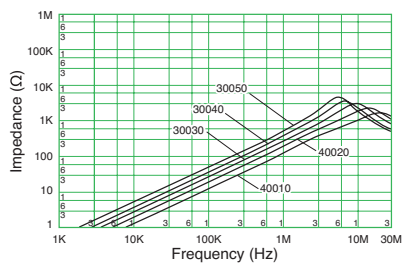

- All specifications in this catalog and production status of products are subject to change without notice. Prior to the purchase, please contact NEC TOKIN for updated product data.
- Please request for a specification sheet for detailed product data prior to the purchase.
- Before using the product in this catalog, please read "Precautions" and other safety precautions listed in the printed version catalog.

SS Coils

SS11VL Type

[RoHS Compliant]



- <Features> · Super low profile : 20.5mm max. (19.5±1mm)
 · High permeability core realizes high inductance (SS11VL-R type)
 · Best suites for internal power supply of compact adaptor and other thin - cased devices.

Model	Rated current AC(A)	Inductance (mH) min.	DC resistance (Ω/line) max.	Temperature rise(K) max.	Marking	Weight approx. (g)
SS11VL-03550	0.3	55	4.1	45	03 LOT No.	10.5
SS11VL-04350	0.4	35	2.6	45	04 LOT No.	10.7
SS11VL-05230	0.5	23	1.8	45	05 LOT No.	10.5
SS11VL-06180	0.6	18	1.3	45	06 LOT No.	11.1
SS11VL-07120	0.7	12	0.90	45	07 LOT No.	10.8
SS11VL-08083	0.8	8.3	0.74	45	08 LOT No.	9.8
SS11VL-10062	1.0	6.2	0.44	45	10 LOT No.	11.1
SS11VL-11050	1.1	5.0	0.40	45	11 LOT No.	10.7
SS11VL-13035	1.3	3.5	0.28	45	13 LOT No.	10.5
SS11VL-17024	1.7	2.4	0.19	45	17 LOT No.	10.8
SS11VL-22013	2.2	1.3	0.12	45	22 LOT No.	10.4
SS11VL-30006	3.0	0.6	0.06	45	30 LOT No.	9.6
SS11VL-R03820	0.3	82	4.1	45	R03 LOT No.	10.5
SS11VL-R04520	0.4	52	2.6	45	R04 LOT No.	10.7
SS11VL-R05350	0.5	35	1.8	45	R05 LOT No.	10.5
SS11VL-R06270	0.6	27	1.3	45	R06 LOT No.	11.1
SS11VL-R07190	0.7	19	0.90	45	R07 LOT No.	10.8
SS11VL-R08125	0.8	12.5	0.74	45	R08 LOT No.	9.8
SS11VL-R10093	1.0	9.3	0.44	45	R10 LOT No.	11.1
SS11VL-R11076	1.1	7.6	0.40	45	R11 LOT No.	10.7
SS11VL-R13052	1.3	5.2	0.28	45	R13 LOT No.	10.5
SS11VL-R17036	1.7	3.6	0.19	45	R17 LOT No.	10.8
SS11VL-R22020	2.2	2.0	0.12	45	R22 LOT No.	10.4
SS11VL-R30009	3.0	0.9	0.06	45	R30 LOT No.	9.6

- Rated voltage: 250VAC • Withstanding voltage: AC 2400V (2 sec between lines)
- Insulation resistance: at 500VDC, more than 100MΩ (between lines) • Thermal class: E (120°C)
- Operating temperature range (°C): -25 to T (T=120-temperature rise) • Inductance measurement condition: 1kHz, 1V, KC530

Shape and Dimensions

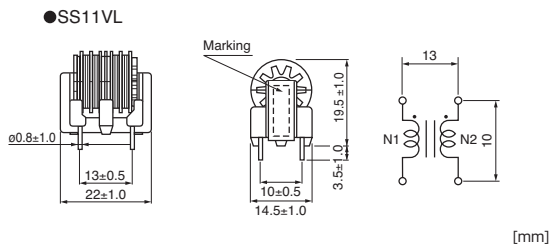

Numbering System

SS 11VL- 03 550

① ② ③ ④ ⑤ ⑥

- ① Series
- ② Core size
- ③ Type (VL : vertical)
- ④ Core Type (R : high permeability core)
- ⑤ Rated current (03 stands for 0.3A)
- ⑥ Inductance (550 stands for 55.0mH)



- All specifications in this catalog and production status of products are subject to change without notice. Prior to the purchase, please contact NEC TOKIN for updated product data.
- Please request for a specification sheet for detailed product data prior to the purchase.
- Before using the product in this catalog, please read "Precautions" and other safety precautions listed in the printed version catalog.

Frequency characteristic

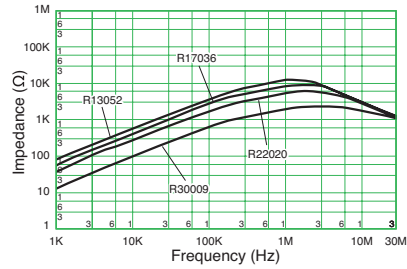
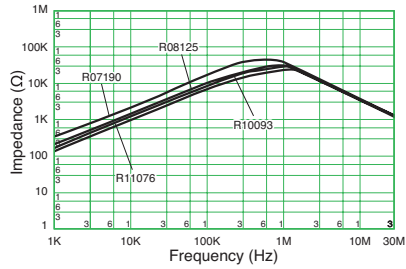
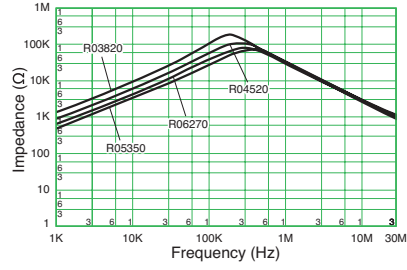
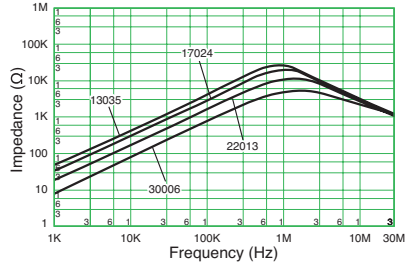
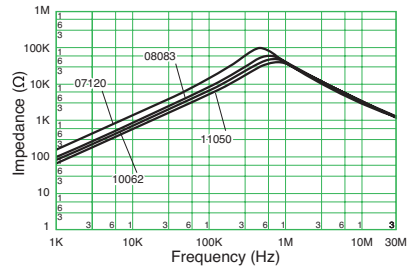
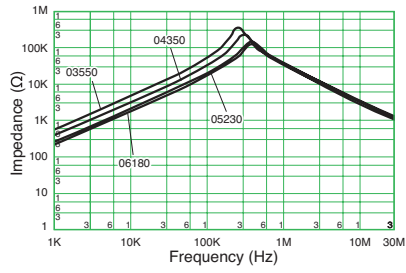

- All specifications in this catalog and production status of products are subject to change without notice. Prior to the purchase, please contact NEC TOKIN for updated product data.
- Please request for a specification sheet for detailed product data prior to the purchase.
- Before using the product in this catalog, please read "Precautions" and other safety precautions listed in the printed version catalog.

SS Coils

SS11V/H-CH Type

[RoHS Compliant]



Model	Rated current AC(A)	Inductance (mH) min.	DC resistance (Ω/line) max.	Temperature rise(K) max.	Marking	Weight approx. (g)
SS11V/H-03550-CH	0.3	55	4.1	45	03 lot No.	10.5
SS11V/H-04350-CH	0.4	35	2.6	45	04 lot No.	10.7
SS11V/H-05230-CH	0.5	23	1.8	45	05 lot No.	10.5
SS11V/H-06180-CH	0.6	18	1.3	45	06 lot No.	11.1
SS11V/H-07120-CH	0.7	12	0.90	45	07 lot No.	10.8
SS11V/H-08083-CH	0.8	8.3	0.74	45	08 lot No.	9.8
SS11V/H-10062-CH	1.0	6.2	0.44	45	10 lot No.	11.1
SS11V/H-11050-CH	1.1	5	0.40	45	11 lot No.	10.7
SS11V/H-13035-CH	1.3	3.5	0.28	45	13 lot No.	10.5
SS11V/H-17024-CH	1.7	2.4	0.19	45	17 lot No.	10.8
SS11V/H-22013-CH	2.2	1.3	0.12	45	22 lot No.	10.4
SS11V/H-30006-CH	3.0	0.6	0.063	45	30 lot No.	9.6
SS11V/H-R03820-CH	0.3	82	4.1	45	R03 lot No.	10.5
SS11V/H-R04520-CH	0.4	52	2.6	45	R04 lot No.	10.7
SS11V/H-R05350-CH	0.5	35	1.8	45	R05 lot No.	10.5
SS11V/H-R06270-CH	0.6	27	1.3	45	R06 lot No.	11.1
SS11V/H-R07190-CH	0.7	19	0.90	45	R07 lot No.	10.8
SS11V/H-R08125-CH	0.8	12.5	0.74	45	R08 lot No.	9.8
SS11V/H-R10093-CH	1.0	9.3	0.44	45	R10 lot No.	11.1
SS11V/H-R11076-CH	1.1	7.6	0.40	45	R11 lot No.	10.7
SS11V/H-R13052-CH	1.3	5.2	0.28	45	R13 lot No.	10.5
SS11V/H-R17036-CH	1.7	3.6	0.19	45	R17 lot No.	10.8
SS11V/H-R22020-CH	2.2	2	0.12	45	R22 lot No.	10.4
SS11V/H-R30009-CH	3.0	0.9	0.063	45	R30 lot No.	9.6

- Rated voltage: 250VAC • Withstanding voltage: AC 2400V (2 sec between lines)
- Insulation resistance: at 500VDC, more than 100MΩ (between lines) • Thermal class: E (120°C)
- Operating temperature range (°C): -25 to T (T=120-temperature rise) • Inductance measurement condition:1kHz, 1V, KC530

Shape and Dimensions

●SS11V-CH

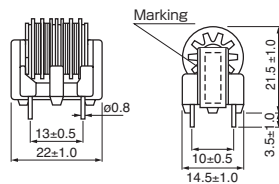

●SS11H-CH

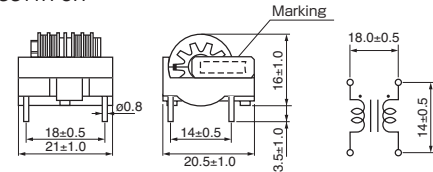

[mm]

Numbering System

SS 11V/H - 03 550 - CH

① ② ③ ④ ⑤ ⑥ ⑦

- ① Series
- ② Core size
- ③ Type (V : vertical H : horizontal)
- ④ Core Type
- ⑤ Rated current (03 stands for 0.3A)
- ⑥ Inductance (550 stands for 55.0mH)
- ⑦ Product type



- All specifications in this catalog and production status of products are subject to change without notice. Prior to the purchase, please contact NEC TOKIN for updated product data.
- Please request for a specification sheet for detailed product data prior to the purchase.
- Before using the product in this catalog, please read "Precautions" and other safety precautions listed in the printed version catalog.

Frequency characteristic

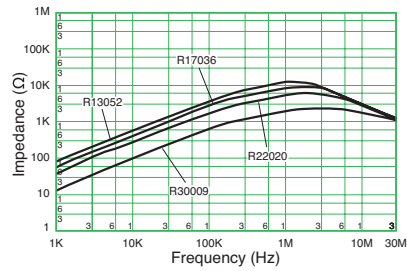
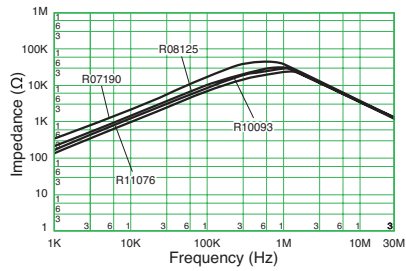
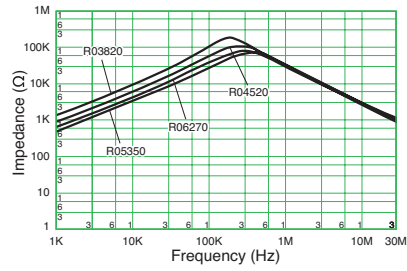
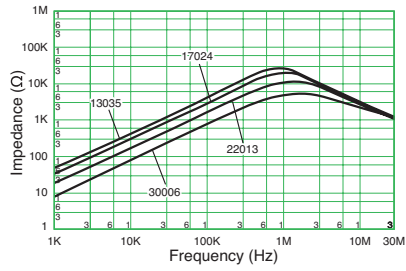
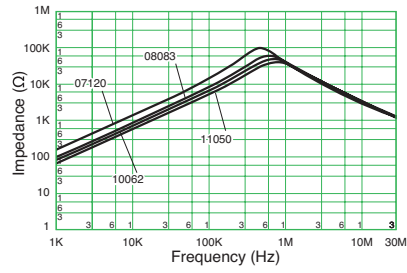
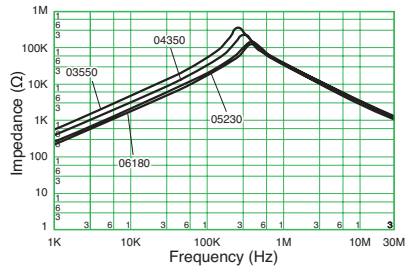

- All specifications in this catalog and production status of products are subject to change without notice. Prior to the purchase, please contact NEC TOKIN for updated product data.
- Please request for a specification sheet for detailed product data prior to the purchase.
- Before using the product in this catalog, please read "Precautions" and other safety precautions listed in the printed version catalog.

SS Coils

SSB11V-R/11H-R Type

A common mode choke coil for class B

[RoHS Compliant]

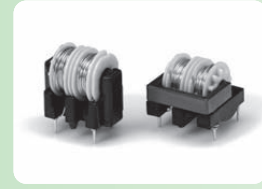

Model	Rated current (A)	Inductance (mH) min.	DC resistance (Ω/line) max.	Temperature rise(K) max.	Weight approx. (g)
SSB11V/H-R13090	1.3	9.0	0.38	60	11.0
SSB11V/H-R17043	1.7	4.3	0.18	40	11.0

- Rated voltage: 250VAC • Withstanding voltage: AC 2400V (2 sec between lines)
- Insulation resistance: at 500VDC, more than 100MΩ (between lines) • Thermal class: B (130°C)
- Operating temperature range (°C): -25 to T (T=130-temperature rise) • Inductance measurement condition: 1kHz, 1V, KC530

Shape and Dimensions

●SSB11V-R

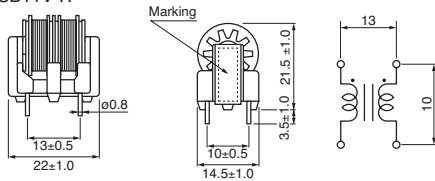

●SSB11H-R

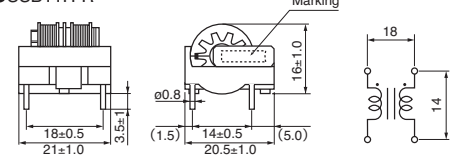

[mm]

Numbering System

SSB 11 V-R - 13 090

- ① ② ③ ④ ⑤

- ① Series
- ② Core size
- ③ Type (V: vertical, H: horizontal)
- ④ Rated current (08 stands for 0.8A)
- ⑤ Inductance (125 stands for 12.5mH)

Impedance vs. Frequency

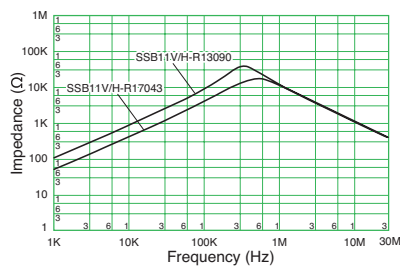

- All specifications in this catalog and production status of products are subject to change without notice. Prior to the purchase, please contact NEC TOKIN for updated product data.
- Please request for a specification sheet for detailed product data prior to the purchase.
- Before using the product in this catalog, please read "Precautions" and other safety precautions listed in the printed version catalog.

SS Coils

SS17HB Type

[RoHS Compliant]



Model	Rated current AC(A)	Wire diameter (mm)	Inductance (mH) min.	DC resistance (Ω/line) max.	Temperature rise(K) max.	Marking	Weight approx. (g)
SS17HB-03225	0.3	0.20	22.5	2.60	48	03 Lot No.	5.9
SS17HB-04125	0.4	0.23	12.5	1.40	53	04 Lot No.	6.5
SS17HB-05100	0.5	0.25	10.0	1.10	55	05 Lot No.	6.4
SS17HB-06085	0.6	0.28	8.5	0.84	45	06 Lot No.	6.0
SS17HB-07065	0.7	0.30	6.5	0.70	50	07 Lot No.	6.0
SS17HB-08050	0.8	0.30	5.0	0.45	58	08 Lot No.	5.9
SS17HB-10025	1.0	0.37	2.5	0.38	50	10 Lot No.	6.3
SS17HB-11020	1.1	0.37	2.0	0.24	65	11 Lot No.	6.3
SS17HB-13018	1.3	0.40	1.5	0.18	55	13 Lot No.	6.2
SS17HB-17008	1.7	0.45	0.8	0.12	55	17 Lot No.	6.1
SS17HB-R03300	0.3	0.20	30.0	2.60	48	R03 Lot No.	5.9
SS17HB-R04170	0.4	0.23	17.0	1.40	53	R04 Lot No.	6.5
SS17HB-R05140	0.5	0.25	14.0	1.10	55	R05 Lot No.	6.4
SS17HB-R06120	0.6	0.28	12.0	0.84	45	R06 Lot No.	6.0
SS17HB-R07090	0.7	0.30	9.0	0.70	50	R07 Lot No.	6.0
SS17HB-R08070	0.8	0.30	7.0	0.45	58	R08 Lot No.	5.9
SS17HB-R10035	1.0	0.37	3.5	0.38	50	R10 Lot No.	6.3
SS17HB-R11025	1.1	0.37	2.5	0.24	65	R11 Lot No.	6.3
SS17HB-R13020	1.3	0.40	2.0	0.18	55	R13 Lot No.	6.2
SS17HB-R17010	1.7	0.45	1.0	0.12	55	R17 Lot No.	6.1

- Rated voltage:250VAC
- Thermal class:E(120°C)
- Withstanding voltage:AC 2400V for 2seconds (between lines)
- Operating temperature range(°C):-25 to T (T=120-temperature rise)
- Inductance measurement condition:1kHz, 1V, KC530 or equivalent

Shape and Dimensions

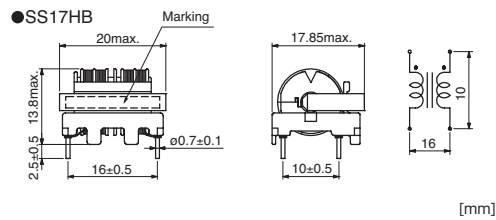

Numbering System

SS 17HB - 03 225

① ② ③ ④ ⑤

- ① Series name
- ② Core size(H shows a horizontal type)
- ③ Core type(Nothing shows standard core type, R shows a high-μ core type)
- ④ Current rating(03 shows 0.3A)
- ⑤ Inductance(225 shows 22.5mH)



- All specifications in this catalog and production status of products are subject to change without notice. Prior to the purchase, please contact NEC TOKIN for updated product data.
- Please request for a specification sheet for detailed product data prior to the purchase.
- Before using the product in this catalog, please read "Precautions" and other safety precautions listed in the printed version catalog.

Impedance vs. Frequency

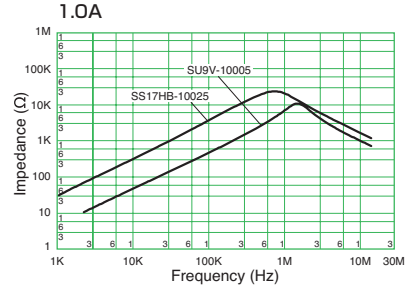
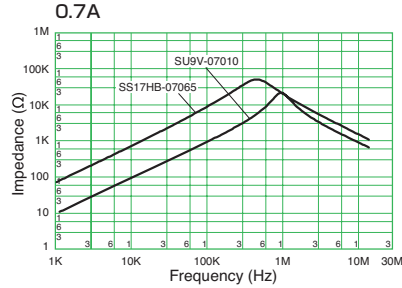
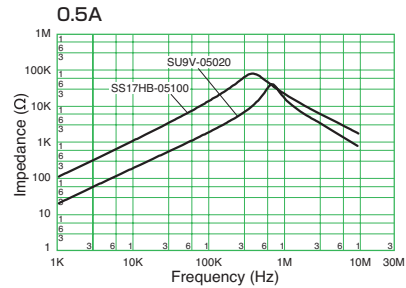
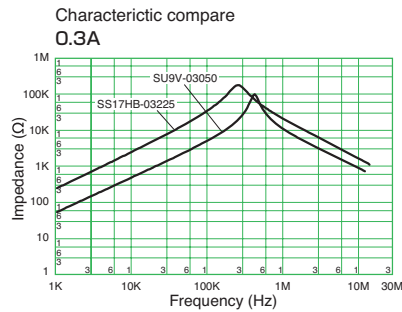
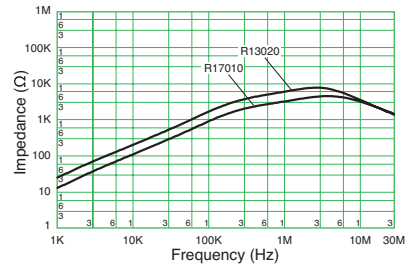
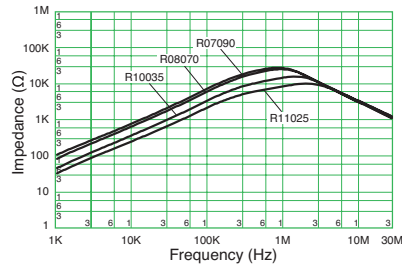
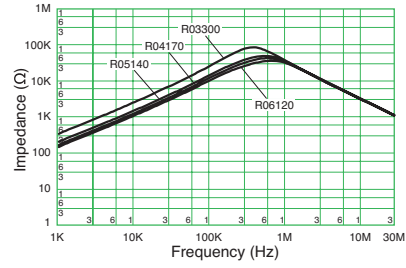
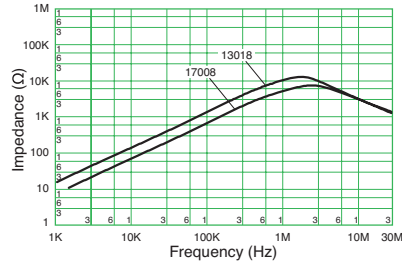
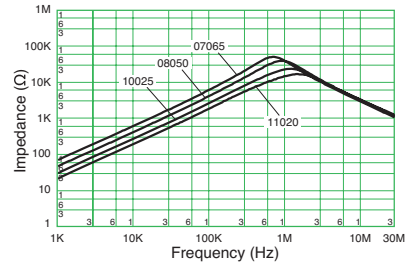
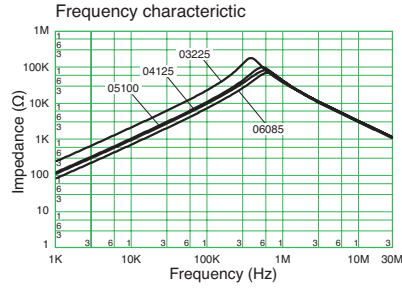

- All specifications in this catalog and production status of products are subject to change without notice. Prior to the purchase, please contact NEC TOKIN for updated product data.
- Please request for a specification sheet for detailed product data prior to the purchase.
- Before using the product in this catalog, please read "Precautions" and other safety precautions listed in the printed version catalog.

Impedance vs. Frequency

Frequency characteristic

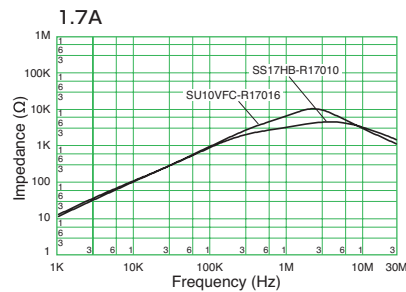
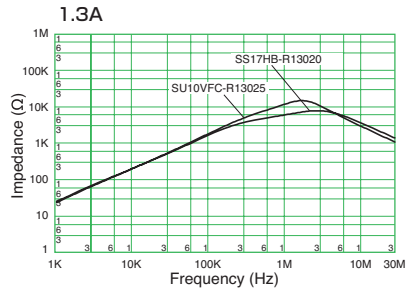
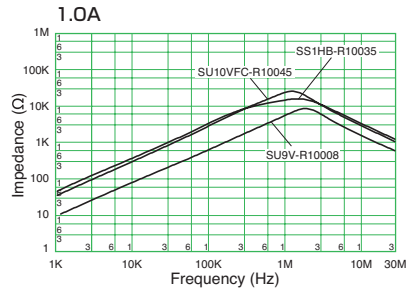
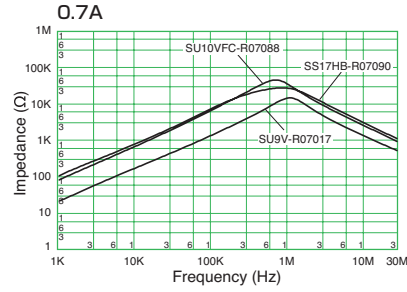
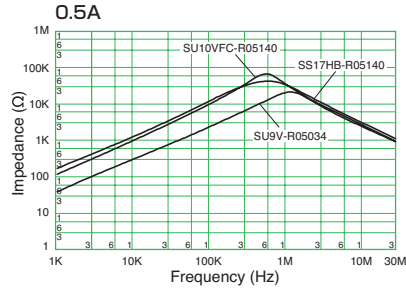
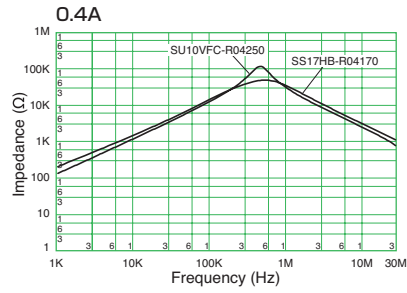
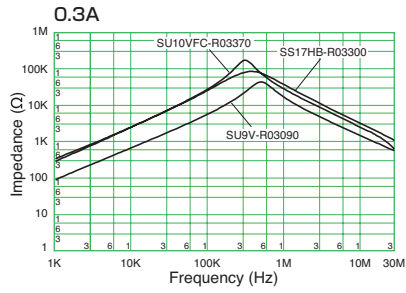

AC Line Filters



- All specifications in this catalog and production status of products are subject to change without notice. Prior to the purchase, please contact NEC TOKIN for updated product data.
- Please request for a specification sheet for detailed product data prior to the purchase.
- Before using the product in this catalog, please read "Precautions" and other safety precautions listed in the printed version catalog.

SS Coils

SS17VA/HA Type

[RoHS Compliant]

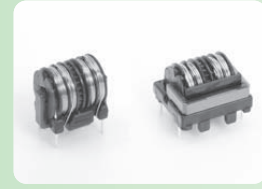

Model	Rated current AC(A)	Wire diameter (mm)	Inductance (mH) min.	DC resistance (Ω /line) max.	Temperature rise(K) max.	Marking	Weight approx. (g)
SS17VA/HA-03155	0.3	0.20	15.5	2.60	48	03 Lot No.	5.7
SS17VA/HA-04085	0.4	0.23	8.5	1.40	53	04 Lot No.	5.6
SS17VA/HA-05070	0.5	0.25	7.0	1.10	55	05 Lot No.	5.8
SS17VA/HA-06060	0.6	0.28	6.0	0.84	45	06 Lot No.	5.8
SS17VA/HA-07045	0.7	0.30	4.5	0.70	50	07 Lot No.	5.9
SS17VA/HA-08035	0.8	0.30	3.5	0.45	58	08 Lot No.	8.9
SS17VA/HA-10015	1.0	0.37	1.5	0.38	50	10 Lot No.	6.0
SS17VA/HA-11013	1.1	0.37	1.3	0.24	65	11 Lot No.	5.7
SS17VA/HA-13010	1.3	0.40	1.0	0.18	55	13 Lot No.	5.7
SS17VA/HA-17005	1.7	0.45	0.5	0.12	55	17 Lot No.	5.7
SS17VA/HA-R03200	0.3	0.20	20.0	2.60	48	R03 Lot No.	5.7
SS17VA/HA-R04110	0.4	0.23	11.0	1.40	53	R04 Lot No.	5.6
SS17VA/HA-R05090	0.5	0.25	9.0	1.10	55	R05 Lot No.	5.8
SS17VA/HA-R06075	0.6	0.28	7.5	0.84	45	R06 Lot No.	5.8
SS17VA/HA-R07060	0.7	0.30	6.0	0.70	50	R07 Lot No.	5.9
SS17VA/HA-R08045	0.8	0.30	4.5	0.45	58	R08 Lot No.	8.9
SS17VA/HA-R10025	1.0	0.37	2.5	0.38	50	R10 Lot No.	6.0
SS17VA/HA-R11015	1.1	0.37	1.5	0.24	65	R11 Lot No.	5.7
SS17VA/HA-R13012	1.3	0.40	1.2	0.18	55	R13 Lot No.	5.7
SS17VA/HA-R17007	1.7	0.45	0.7	0.12	55	R17 Lot No.	5.7

- Rated voltage:250VAC • Thermal class:E(120°C) • Withstanding voltage:AC 2400V for 2seconds (between lines)
- Operating temperature range(°C):-25 to T (T=120-temperature rise) • Inductance measurement condition:1kHz, 1V, KC530 or equivalent

Shape and Dimensions

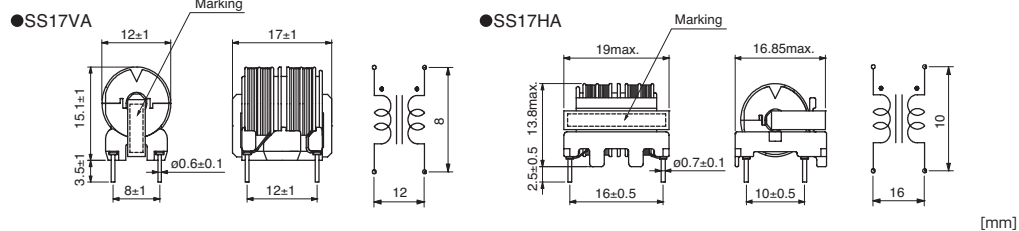

Numbering System

SS 17VA/HA - 03 155

① ② ③ ④ ⑤

- ① Series name
- ② Core size(VA/HA shows a vertical or horizontal type)
- ③ Core type(Nothing shows standard core type, R shows a high- μ core type)
- ④ Current rating(03 shows 0.3A)
- ⑤ Inductance(155 shows 15.5mH)



- All specifications in this catalog and production status of products are subject to change without notice. Prior to the purchase, please contact NEC TOKIN for updated product data.
- Please request for a specification sheet for detailed product data prior to the purchase.
- Before using the product in this catalog, please read "Precautions" and other safety precautions listed in the printed version catalog.

Impedance vs. Frequency

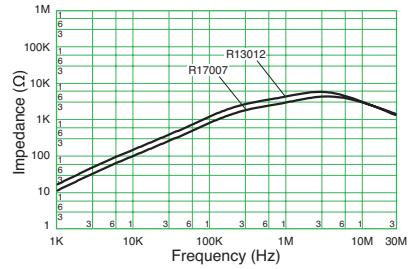
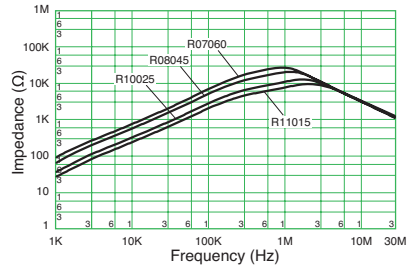
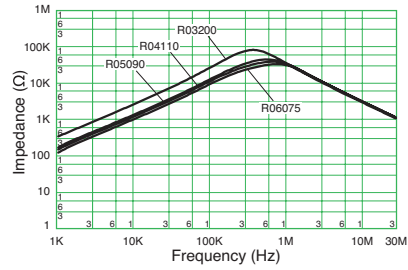
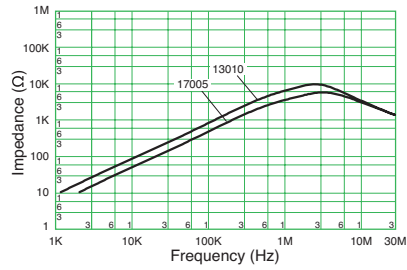
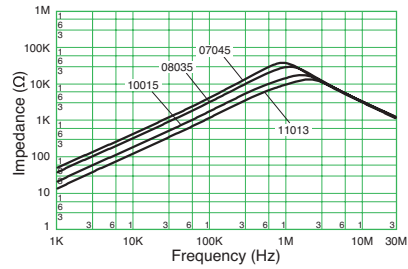
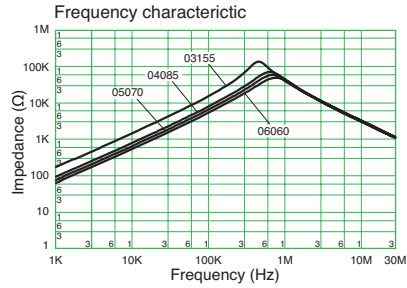

Characteristic compare
0.3A

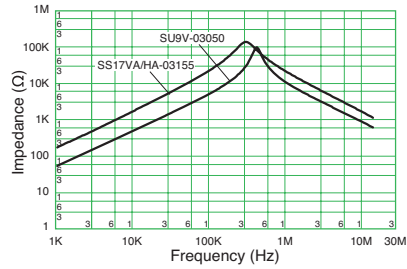

0.5A

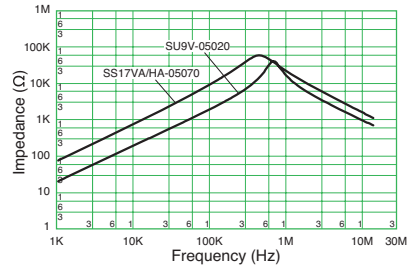

0.7A

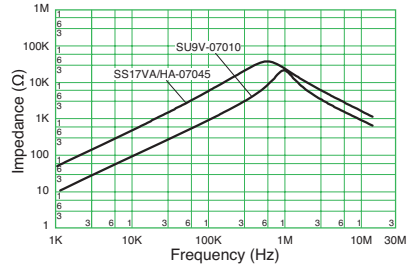

1.0A

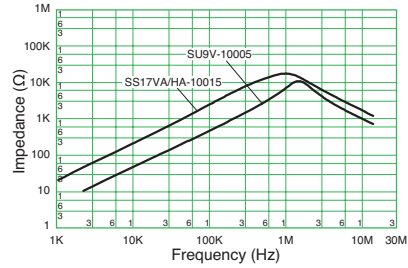

- All specifications in this catalog and production status of products are subject to change without notice. Prior to the purchase, please contact NEC TOKIN for updated product data.
- Please request for a specification sheet for detailed product data prior to the purchase.
- Before using the product in this catalog, please read "Precautions" and other safety precautions listed in the printed version catalog.

Impedance vs. Frequency

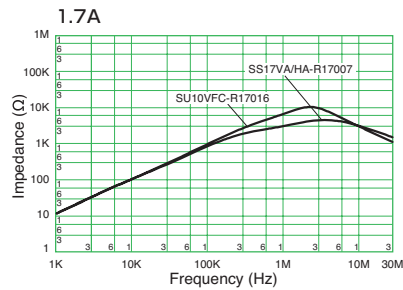
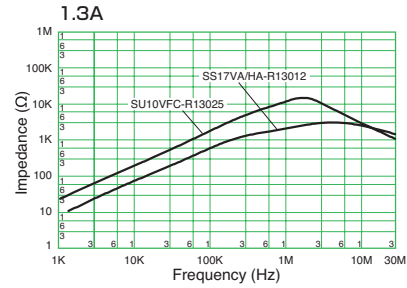
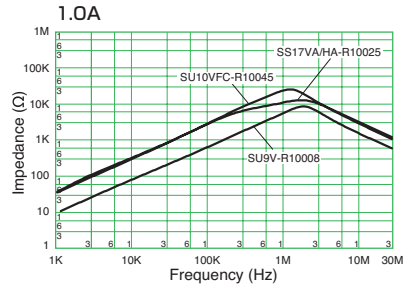
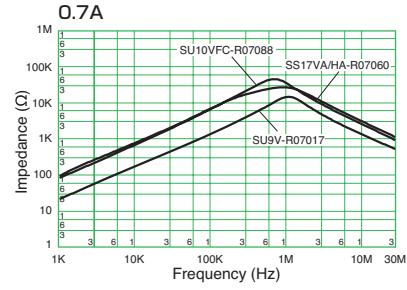
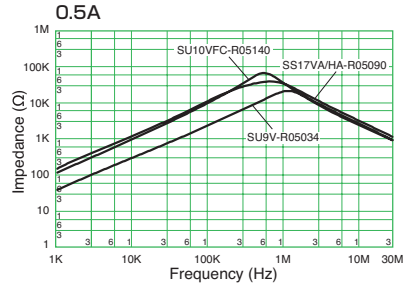
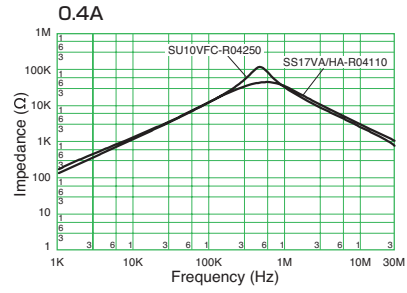
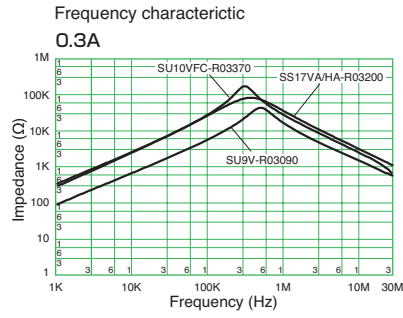

- All specifications in this catalog and production status of products are subject to change without notice. Prior to the purchase, please contact NEC TOKIN for updated product data.
- Please request for a specification sheet for detailed product data prior to the purchase.
- Before using the product in this catalog, please read "Precautions" and other safety precautions listed in the printed version catalog.

SS Coils

SS20H Type

[RoHS Compliant]



Model	Rated current AC(A)	Inductance (mH) min.	DC resistance (Ω/line) max.	Temperature rise(K) max.	Marking	Weight approx. (g)
SS20H-03510	0.3	51	3.2	45	03 lot No.	12.0
SS20H-04340	0.4	34	2.0	45	04 lot No.	12.0
SS20H-05270	0.5	27	1.5	45	05 lot No.	12.0
SS20H-06150	0.6	15	0.93	45	06 lot No.	12.0
SS20H-07130	0.7	13	0.75	45	07 lot No.	12.0
SS20H-08100	0.8	10	0.66	45	08 lot No.	12.0
SS20H-10080	1.0	8.0	0.42	45	10 lot No.	12.0
SS20H-12050	1.2	5.0	0.36	45	12 lot No.	12.0
SS20H-13044	1.3	4.4	0.25	45	13 lot No.	12.0
SS20H-15029	1.5	2.9	0.19	45	15 lot No.	12.0
SS20H-20018	2.0	1.8	0.11	45	20 lot No.	12.0
SS20H-R03660	0.3	66	3.2	45	R03 lot No.	12.0
SS20H-R04450	0.4	45	2.0	45	R04 lot No.	12.0
SS20H-R05350	0.5	35	1.5	45	R05 lot No.	12.0
SS20H-R06200	0.6	20	0.93	45	R06 lot No.	12.0
SS20H-R07160	0.7	16	0.75	45	R07 lot No.	12.0
SS20H-R08125	0.8	12.5	0.66	45	R08 lot No.	12.0
SS20H-R10100	1.0	10.0	0.42	45	R10 lot No.	12.0
SS20H-R12063	1.2	6.3	0.36	45	R12 lot No.	12.0
SS20H-R13052	1.3	5.2	0.25	45	R13 lot No.	12.0
SS20H-R15033	1.5	3.3	0.19	45	R15 lot No.	12.0
SS20H-R20023	2.0	2.3	0.11	45	R20 lot No.	12.0

- Rated voltage: 250VAC • Withstanding voltage: AC 2400V (2 sec between lines)
- Insulation resistance: at 500VDC, more than 100MΩ (between lines) • Thermal class: E (120°C)
- Operating temperature range (°C): -25 to T (T=120-temperature rise) • Inductance measurement condition: 1kHz, 1V, KC530

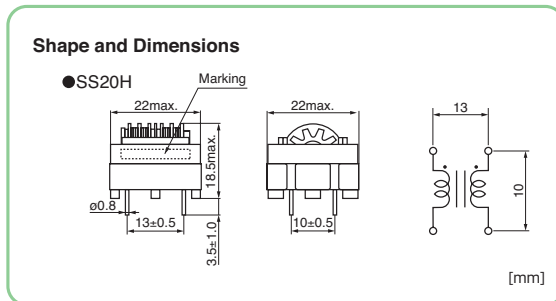

Numbering System

SS 20 H - 03 510

- ① ② ③ ④ ⑤ ⑥

- ① Series
- ② Core size
- ③ Type (V: vertical, H: horizontal)
- ④ Core type (R:high permeability core)
- ⑤ Rated current (03 stands for 0.3A)
- ⑥ Inductance (510 stands for 51mH)



- All specifications in this catalog and production status of products are subject to change without notice. Prior to the purchase, please contact NEC TOKIN for updated product data.
- Please request for a specification sheet for detailed product data prior to the purchase.
- Before using the product in this catalog, please read "Precautions" and other safety precautions listed in the printed version catalog.

Frequency characteristic

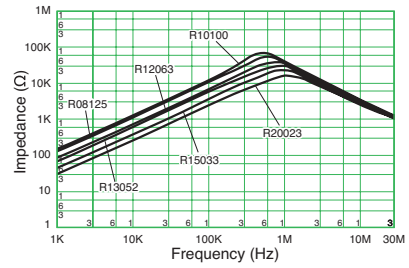
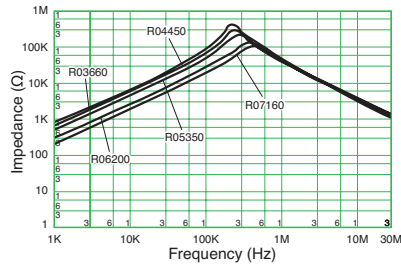
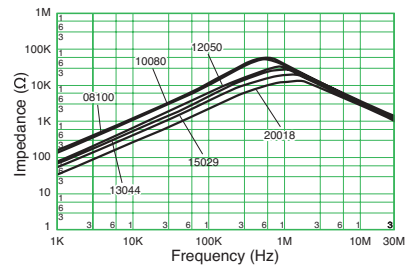
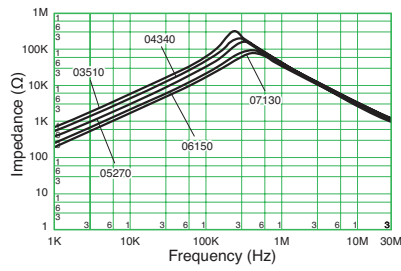

- All specifications in this catalog and production status of products are subject to change without notice. Prior to the purchase, please contact NEC TOKIN for updated product data.
- Please request for a specification sheet for detailed product data prior to the purchase.
- Before using the product in this catalog, please read "Precautions" and other safety precautions listed in the printed version catalog.

SS Coils

SS21V Type

[RoHS Compliant]

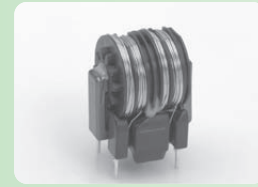

- <Features>
- High inductance yet compact design enables replacement for SS24V-type and SS11V-type
 - High permeability core realizes high inductance (R-types)
 - Approx. 38% reduced volume and covers approx. 70 to 98% inductance compared with SS24V type.
 - Approx. 21% volume increase when compared with SS11V-type; however, MAX inductance is approx. 70% increase.
 - Pin pitch is identical to SS24V-type and SS11V-type, thus making designing easy.
- ※The comparison is with same rated current product's standard specification.

Model	Rated current AC(A)	Inductance (mH) min.	DC resistance (Ω/line) max.	Temperature rise(K) max.	Marking	Weight approx. (g)
SS21V-030930	0.3	93.0	5.9	50	03 LOT No.	12.3
SS21V-040520	0.4	52.0	5.4	50	04 LOT No.	12.2
SS21V-050360	0.5	36.0	2.4	50	05 LOT No.	12.2
SS21V-060220	0.6	22.0	1.5	45	06 LOT No.	12.9
SS21V-070179	0.7	17.9	1.1	50	07 LOT No.	13.2
SS21V-080136	0.8	13.6	0.8	45	08 LOT No.	13.4
SS21V-100098	1.0	9.8	0.6	50	10 LOT No.	13.1
SS21V-110067	1.1	6.7	0.45	45	11 LOT No.	12.8
SS21V-130044	1.3	4.4	0.35	50	13 LOT No.	11.5
SS21V-150038	1.5	3.8	0.30	50	15 LOT No.	12.4
SS21V-180029	1.8	2.9	0.20	45	18 LOT No.	13.3
SS21V-200024	2.0	2.4	0.15	50	20 LOT No.	12.6
SS21V-220017	2.2	1.7	0.13	45	22 LOT No.	12.7
SS21V-250015	2.5	1.5	0.10	50	25 LOT No.	12.3
SS21V-300008	3.0	0.8	0.07	50	30 LOT No.	11.7
SS21V-R031380	0.3	138.0	5.9	50	R03 LOT No.	12.3
SS21V-R040770	0.4	77.0	5.4	50	R04 LOT No.	12.2
SS21V-R050540	0.5	54.0	2.4	50	R05 LOT No.	12.2
SS21V-R060330	0.6	33.0	1.5	45	R06 LOT No.	12.9
SS21V-R070260	0.7	26.0	1.1	50	R07 LOT No.	13.2
SS21V-R080200	0.8	20.0	0.8	45	R08 LOT No.	13.4
SS21V-R100146	1.0	14.6	0.6	50	R10 LOT No.	13.1
SS21V-R110100	1.1	10.0	0.45	45	R11 LOT No.	12.8
SS21V-R130066	1.3	6.6	0.35	50	R13 LOT No.	11.5
SS21V-R150057	1.5	5.7	0.30	50	R15 LOT No.	12.4
SS21V-R180044	1.8	4.4	0.20	45	R18 LOT No.	13.3
SS21V-R200036	2.0	3.6	0.15	50	R20 LOT No.	12.6
SS21V-R220026	2.2	2.6	0.13	45	R22 LOT No.	12.7
SS21V-R250023	2.5	2.3	0.10	50	R25 LOT No.	12.3
SS21V-R300013	3.0	1.3	0.07	50	R30 LOT No.	11.7

- Rated voltage:250VAC • Withstanding voltage:2400V AC for 2sec.(between lines)
- Insulation resistance: at 500VDC, more than 100MΩ (between lines) • Thermal class:E (120°C)
- Operating temperature range(°C):-25 to T (T=120-temperature rise) • Inductance measurement condition:1kHz, 1V, KC530

Shape and Dimensions

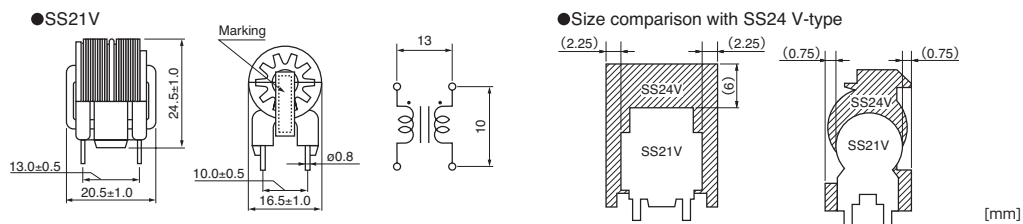

- All specifications in this catalog and production status of products are subject to change without notice. Prior to the purchase, please contact NEC TOKIN for updated product data.
- Please request for a specification sheet for detailed product data prior to the purchase.
- Before using the product in this catalog, please read "Precautions" and other safety precautions listed in the printed version catalog.

Numbering System

SS 21V - 03 0930

- ①
- ②
- ③
- ④
- ⑤

- ① Series
- ② Type (V: vertical, H: horizontal)
- ③ Core type (No marking : Standard core, R : high permeability core)
- ④ Rated current (0930 stands for 93.0A)
- ⑤ Inductance (0930 stands for 93.0mH)

Frequency characteristic

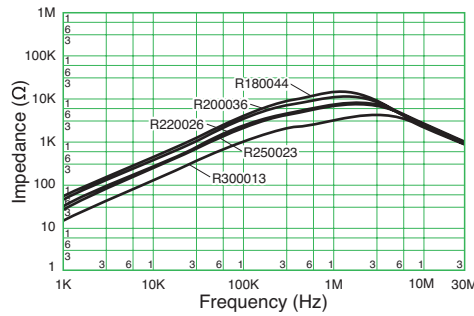
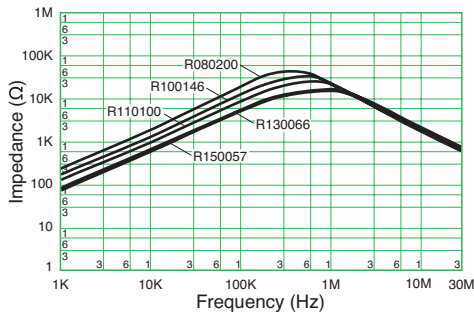
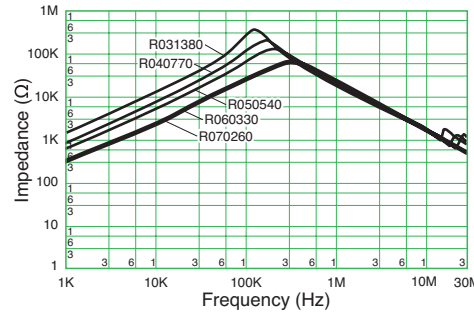
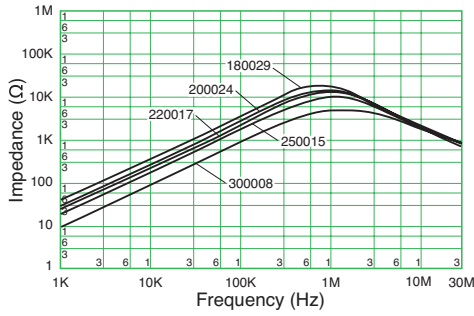
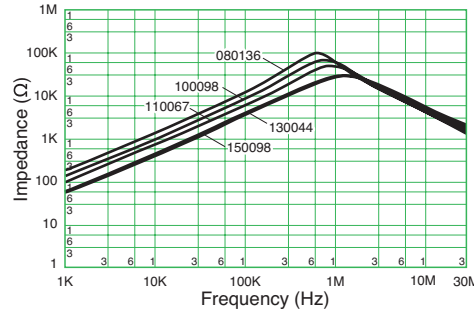
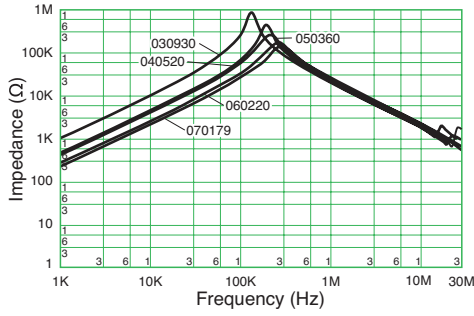

SS Coils

SS24V/H-CH Type

[RoHS Compliant]

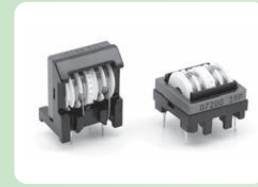

Model	Rated current AC(A)	Inductance (mH) min.	DC resistance (Ω/line) max.	Temperature rise(K) max.	Weight approx.(g)	
					V	H
SS24V/H-05350-CH	0.5	35	1.75	45	18.8	17.1
SS24V/H-08150-CH	0.8	15	0.75	50	18.8	17.1
SS24V/H-10100-CH	1.0	10	0.55	45	18.6	16.9
SS24V/H-15045-CH	1.5	4.5	0.24	45	19.0	17.3
SS24V/H-20025-CH	2.0	2.5	0.17	50	18.3	16.6
SS24V/H-K05570-CH	0.5	57.0	1.75	45	18.8	17.1
SS24V/H-K08240-CH	0.8	24.0	0.75	50	18.8	17.1
SS24V/H-K10165-CH	1.0	16.5	0.55	45	18.6	16.9
SS24V/H-K15070-CH	1.5	7.0	0.24	45	19.0	17.3
SS24V/H-K20040-CH	2.0	4.0	0.17	50	18.3	16.6
SS24V/H-R05600-CH	0.5	60	1.75	45	18.8	17.1
SS24V/H-R08250-CH	0.8	25	0.75	50	18.8	17.1
SS24V/H-R10170-CH	1.0	17	0.55	45	18.6	16.9
SS24V/H-R15080-CH	1.5	8.0	0.24	45	19.0	17.3
SS24V/H-R20045-CH	2.0	4.5	0.17	50	18.3	16.6

- Rated voltage:250VAC • Withstanding voltage: 2400VAC (2sec between lines)
- Insulation resistance: at 500VDC, more than 100MΩ (between lines) • Thermal class: E (120°C)
- Operating temperature range (°C): -25 to T (T=120-temperature rise) • Inductance measurement condition: 1kHz, 1V, KC530

Shape and Dimensions

●SS24V

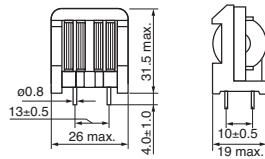

●SS24H

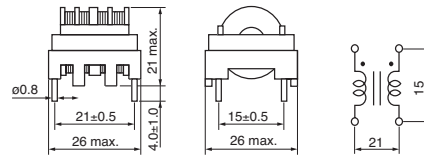

[mm]

Numbering System

SS 24 V - _ - 08 150 - CH
 ① ② ③ ④ ⑤ ⑥ ⑦

- ① Series
- ② Core size
- ③ Core Type (V: vertical, H: horizontal)
- ④
- ⑤ Rated current (08 stands for 0.8A)
- ⑥ Inductance (150 stands for 15mH)
- ⑦ Product type



- All specifications in this catalog and production status of products are subject to change without notice. Prior to the purchase, please contact NEC TOKIN for updated product data.
- Please request for a specification sheet for detailed product data prior to the purchase.
- Before using the product in this catalog, please read "Precautions" and other safety precautions listed in the printed version catalog.

Impedance vs. Frequency

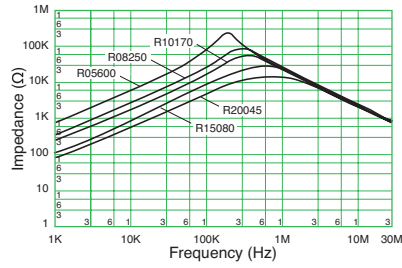
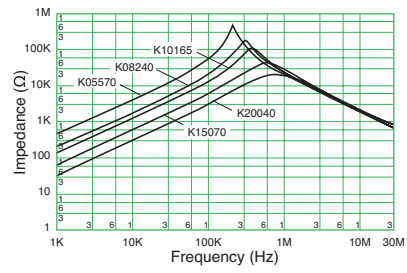
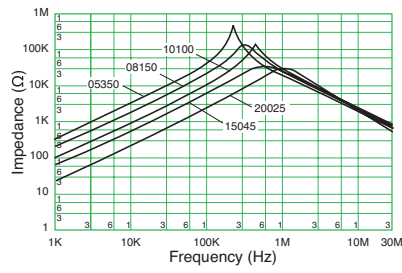

- All specifications in this catalog and production status of products are subject to change without notice. Prior to the purchase, please contact NEC TOKIN for updated product data.
- Please request for a specification sheet for detailed product data prior to the purchase.
- Before using the product in this catalog, please read "Precautions" and other safety precautions listed in the printed version catalog.

SS Coils

SS26V Type

[RoHS Compliant]

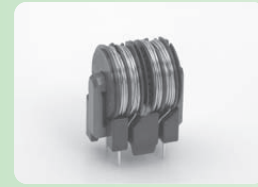

- <Features>
- High inductance yet compact design enables replacement for SS28V-type and SS24V-type
 - Approx. 22% reduced volume and covers approx. 70 to 100% inductance compared with SS28V-type.
 - Approx. only 0.4% volume increase when compared with SS24V-type; however, MAX inductance is approx. 200% increase.
 - Pin pitch is identical to SS28V type and SS24V-type, thus making designing easy.
- ※The comparison is with same rated current product's standard specification.

Model	Rated current AC(A)	Inductance (mH) min.	DC resistance (Ω/line) min. max.	Temperature rise(K) max.	Marking	Weight approx. (g)
SS26V-050880	0.5	88.0	2.4	45	05 LOT No.	25.3
SS26V-060640	0.6	64.0	1.8	45	06 LOT No.	25.4
SS26V-070510	0.7	51.0	1.4	50	07 LOT No.	25.2
SS26V-080350	0.8	35.0	1.0	45	08 LOT No.	25.0
SS26V-100250	1.0	25.0	0.7	45	10 LOT No.	25.8
SS26V-120169	1.2	16.9	0.55	50	12 LOT No.	22.6
SS26V-150121	1.5	12.1	0.40	50	15 LOT No.	23.5
SS26V-180092	1.8	9.2	0.30	50	18 LOT No.	24.3
SS26V-200076	2.0	7.6	0.25	50	20 LOT No.	25.9
SS26V-250046	2.5	4.6	0.15	50	25 LOT No.	24.3
SS26V-300028	3.0	2.8	0.10	50	30 LOT No.	23.0
SS26V-R051170	0.5	117.0	2.4	45	R05 LOT No.	25.3
SS26V-R060860	0.6	86.0	1.8	45	R06 LOT No.	25.4
SS26V-R070680	0.7	68.0	1.4	50	R07 LOT No.	25.2
SS26V-R080470	0.8	47.0	1.0	45	R08 LOT No.	25.0
SS26V-R100330	1.0	33.0	0.7	45	R10 LOT No.	25.8
SS26V-R120220	1.2	22.0	0.55	50	R12 LOT No.	22.6
SS26V-R150162	1.5	16.2	0.40	50	R15 LOT No.	23.5
SS26V-R180123	1.8	12.3	0.30	50	R18 LOT No.	24.3
SS26V-R200102	2.0	10.2	0.25	50	R20 LOT No.	25.9
SS26V-R250061	2.5	6.1	0.15	50	R25 LOT No.	24.3
SS26V-R300038	3.0	3.8	0.10	50	R30 LOT No.	23.0

- Rated voltage: 250VAC
- Withstanding voltage: 2400VAC (2sec between lines)
- Insulation resistance: at 500VDC, more than 100MΩ (between lines)
- Thermal class: E (120°C)
- Operating temperature range (°C): -25 to T (T=120-temperature rise)
- Inductance measurement condition: 1kHz, 1V, KC530

Shape and Dimensions

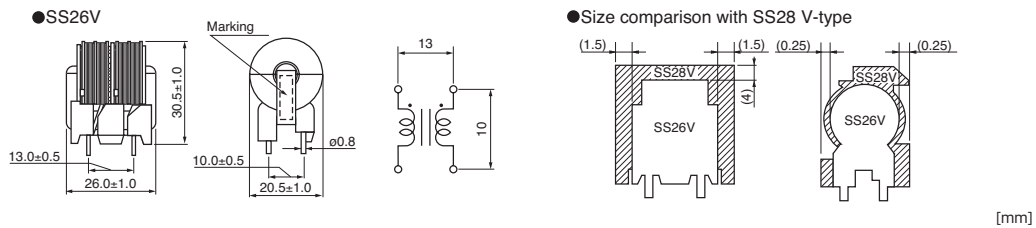

Numbering System

SS 26V - R 05 0880

① ② ③ ④ ⑤

- Series
- Core size ; shupe (V : vertical)
- Core Type (no marking stands for standard type, R : high permeability core)
- Rated current (05 stands for 0.5A)
- Inductance (0880 stands for 88.0mH)



- All specifications in this catalog and production status of products are subject to change without notice. Prior to the purchase, please contact NEC TOKIN for updated product data.
- Please request for a specification sheet for detailed product data prior to the purchase.
- Before using the product in this catalog, please read "Precautions" and other safety precautions listed in the printed version catalog.

Impedance vs. Frequency

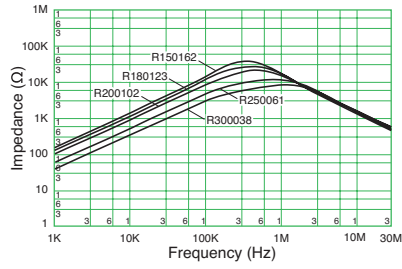
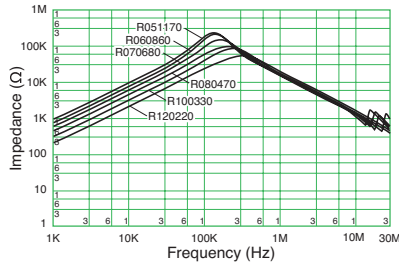
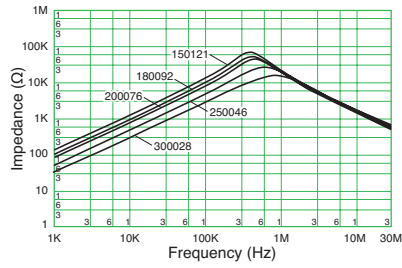
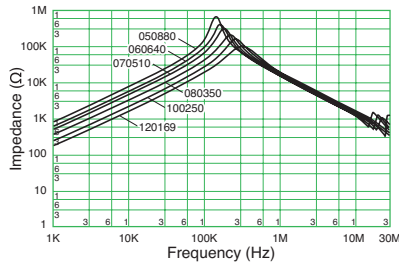

- All specifications in this catalog and production status of products are subject to change without notice. Prior to the purchase, please contact NEC TOKIN for updated product data.
- Please request for a specification sheet for detailed product data prior to the purchase.
- Before using the product in this catalog, please read "Precautions" and other safety precautions listed in the printed version catalog.

SS Coils

SS28V/H-CH Type

[RoHS Compliant]

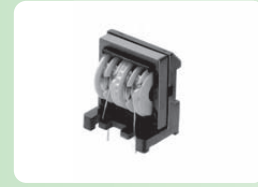

Model	Rated current AC(A)	Inductance (mH) min.	DC resistance (Ω/line) max.	Temperature rise(K) max.	Weight approx.(g)	
					V	H
SS28V/H-08350-CH	0.8	35	0.95	45	32.0	29.6
SS28V/H-10250-CH	1.0	25	0.65	45	33.4	31.0
SS28V/H-15100-CH	1.5	10	0.35	50	30.0	27.6
SS28V/H-20075-CH	2.0	7.5	0.22	45	32.7	30.3
SS28V/H-25045-CH	2.5	4.5	0.16	45	32.9	30.5
SS28V/H-K08530-CH	0.8	53	0.95	45	32.0	29.6
SS28V/H-K10410-CH	1.0	41	0.65	45	33.4	31.0
SS28V/H-K15155-CH	1.5	15.5	0.35	50	30.0	27.6
SS28V/H-K20115-CH	2.0	11.5	0.22	45	32.7	30.3
SS28V/H-K25075-CH	2.5	7.5	0.16	45	32.9	30.5
SS28V/H-R08600-CH	0.8	60	0.95	45	32.0	29.6
SS28V/H-R10450-CH	1.0	45	0.65	45	33.4	31.0
SS28V/H-R15170-CH	1.5	17	0.35	50	30.0	27.6
SS28V/H-R20130-CH	2.0	13	0.22	45	32.7	30.3
SS28V/H-R25080-CH	2.5	8.0	0.16	45	32.9	30.5

- Rated voltage:250VAC • Withstanding voltage: 2400VAC (2sec between lines)
- Insulation resistance: at 500VDC, more than 100MΩ (between lines) • Thermal class: E (120°C)
- Operating temperature range (°C): -25 to T (T=120-temperature rise) • Inductance measurement condition: 1kHz, 1V, KC530

Shape and Dimensions

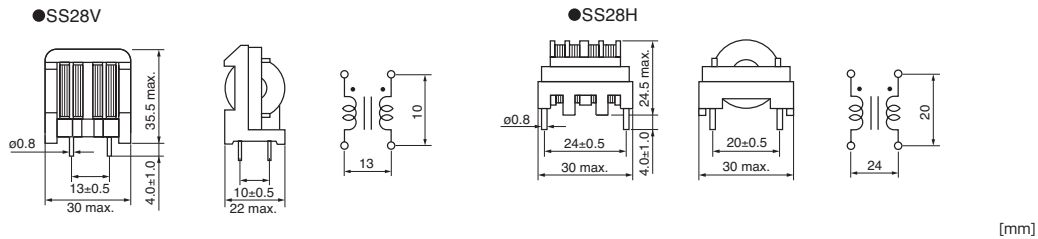

Numbering System

SS 28V/H - 08 350 - CH
 ① ② ③ ④ ⑤ ⑥

- ① Series
- ② Core size ; shupe (V : vertical)
- ③ Core Type (no marking stands for standard type)
- ④ Rated current (08 stands for 0.8A)
- ⑤ Inductance (350 stands for 35mH)
- ⑥ Product type



- All specifications in this catalog and production status of products are subject to change without notice. Prior to the purchase, please contact NEC TOKIN for updated product data.
- Please request for a specification sheet for detailed product data prior to the purchase.
- Before using the product in this catalog, please read "Precautions" and other safety precautions listed in the printed version catalog.

Frequency characteristic

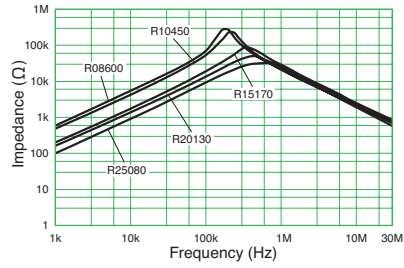
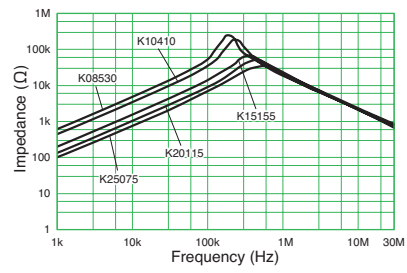
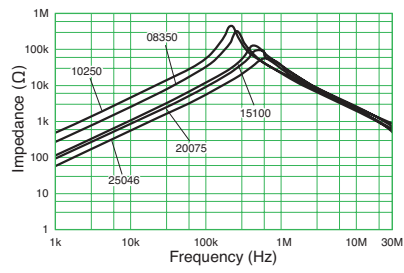

- All specifications in this catalog and production status of products are subject to change without notice. Prior to the purchase, please contact NEC TOKIN for updated product data.
- Please request for a specification sheet for detailed product data prior to the purchase.
- Before using the product in this catalog, please read "Precautions" and other safety precautions listed in the printed version catalog.

SS Coils

SSB28V/H Type

A common mode choke coil for class B

[RoHS Compliant]

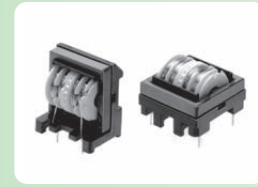

Model	Rated current AC(A)	Inductance (mH) min.	DC resistance (Ω /line) max.	Temperature rise(K) max.	Weight approx.(g)	
					V	H
SSB28V/H -R08600	0.8	60	0.95	45	32.0	29.6
SSB28V/H -R10450	1.0	45	0.65	45	33.4	31.0
SSB28V/H -R15170	1.5	17	0.35	50	30.0	27.6
SSB28V/H -R20130	2.0	13	0.22	45	32.7	30.3
SSB28V/H -R25080	2.5	8.0	0.16	45	32.9	30.5

- Rated voltage:250VAC • Withstanding voltage: 2400VAC (2sec between lines)
- Insulation resistance: at 500VDC, more than 100M Ω (between lines) • Thermal class: B (130°C)
- Operating temperature range (°C): -25 to T (T=120-temperature rise) • Inductance measurement condition: 1kHz, 1V, KC530

Shape and Dimensions

●SSB28V

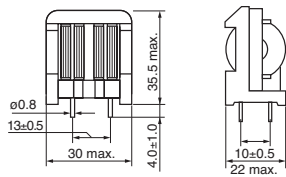

●SSB28H

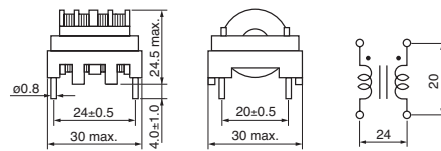

[mm]

Numbering System

SSB 28 V - 08 350

① ② ③ ④ ⑤

- ① Series
- ② Core size
- ③ Type (V: vertical, H: horizontal)
- ④ Rated current (08 stands for 0.8A)
- ⑤ Inductance (350 stands for 35mH)

Impedance vs. Frequency

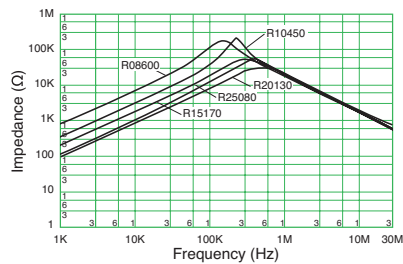

- All specifications in this catalog and production status of products are subject to change without notice. Prior to the purchase, please contact NEC TOKIN for updated product data.
- Please request for a specification sheet for detailed product data prior to the purchase.
- Before using the product in this catalog, please read "Precautions" and other safety precautions listed in the printed version catalog.

SS Coils

SS30V Type

[RoHS Compliant]



- <Features>
- High inductance yet compact design enables replacement for SS35V-type and SS28V-type
 - Approx. 36% reduced volume and covers approx. 60 to 100% inductance compared with SS35V-type.
 - Approx. only 0.2% volume increase when compared with SS28V-type; however, MAX inductance is approx. 60% increase.
 - Please be advised that the pin pitch is different from SS35V-type and SS28V-type
- ※The comparison is with same rated current product's standard specification.

Model	Rated current AC(A)	Inductance (mH) min.	DC resistance (Ω /line) max.	Temperature rise(K) max.	Marking	Weight approx. (g)
SS30V-080730	0.8	73.0	1.5	50	08 LOT No.	35.1
SS30V-100530	1.0	53.0	1.1	50	10 LOT No.	36.8
SS30V-120290	1.2	29.0	0.6	45	12 LOT No.	35.0
SS30V-150200	1.5	20.0	0.5	45	15 LOT No.	35.3
SS30V-180145	1.8	14.5	0.23	50	18 LOT No.	35.2
SS30V-200100	2.0	10.0	0.21	45	20 LOT No.	34.9
SS30V-250070	2.5	7.0	0.16	45	25 LOT No.	34.1
SS30V-300054	3.0	5.4	0.12	45	30 LOT No.	34.6
SS30V-350036	3.5	3.6	0.10	50	35 LOT No.	30.6
SS30V-400021	4.0	2.1	0.07	50	40 LOT No.	29.0
SS30V-450013	4.5	1.3	0.06	50	45 LOT No.	26.1
SS30V-R080960	0.8	96.0	1.5	50	R08 LOT No.	35.1
SS30V-R100700	1.0	70.0	1.1	50	R10 LOT No.	36.8
SS30V-R120380	1.2	38.0	0.6	45	R12 LOT No.	35.0
SS30V-R150270	1.5	27.0	0.5	45	R15 LOT No.	35.3
SS30V-R180190	1.8	19.0	0.23	50	R18 LOT No.	35.2
SS30V-R200132	2.0	13.2	0.21	45	R20 LOT No.	34.9
SS30V-R250092	2.5	9.2	0.16	45	R25 LOT No.	34.1
SS30V-R300071	3.0	7.1	0.12	45	R30 LOT No.	34.6
SS30V-R350047	3.5	4.7	0.10	50	R35 LOT No.	30.6
SS30V-R400028	4.0	2.8	0.07	50	R40 LOT No.	29.0
SS30V-R450017	4.5	1.7	0.06	50	R45 LOT No.	26.1

- Rated voltage:250VAC • Withstanding voltage: 2400VAC (2sec between lines)
- Insulation resistance: at 500VDC, more than 100M Ω (between lines) • Thermal class: E (120°C)
- Operating temperature range (°C): -25 to T (T=120-temperature rise) • Inductance measurement condition: 1kHz, 1V, KC530

Shape and Dimensions

●SS30V

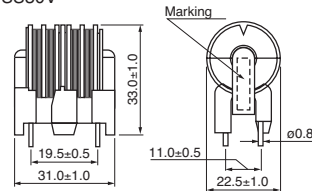

●Size comparison with SS35 V-type

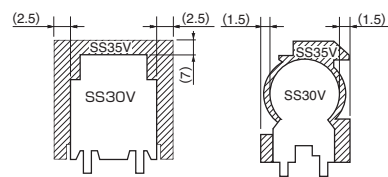

[mm]

Numbering System

SS 30V- 08 0730

① ② ③ ④ ⑤

- Series
- Core size ; shupe (V : vertical)
- Core Type (no marking stands for standard type)
- Rated current (08 stands for 0.8A)
- Inductance (0730 stands for 73.0mH)



- All specifications in this catalog and production status of products are subject to change without notice. Prior to the purchase, please contact NEC TOKIN for updated product data.
- Please request for a specification sheet for detailed product data prior to the purchase.
- Before using the product in this catalog, please read "Precautions" and other safety precautions listed in the printed version catalog.

Impedance vs. Frequency

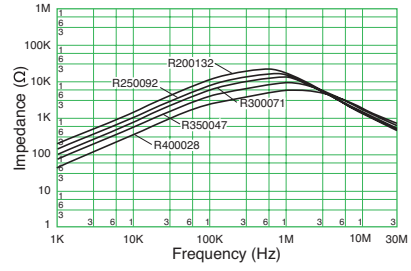
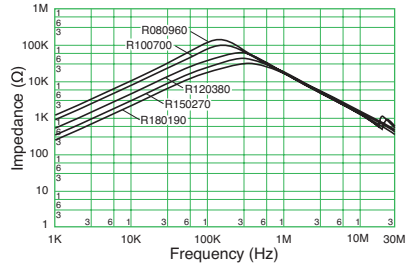
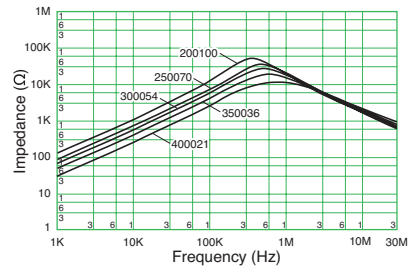
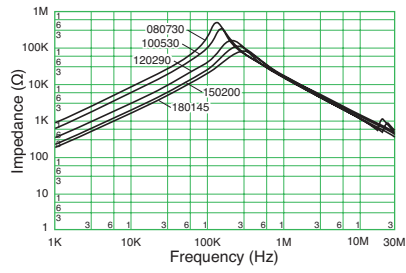

- All specifications in this catalog and production status of products are subject to change without notice. Prior to the purchase, please contact NEC TOKIN for updated product data.
- Please request for a specification sheet for detailed product data prior to the purchase.
- Before using the product in this catalog, please read "Precautions" and other safety precautions listed in the printed version catalog.

SS Coils

SS35V/35H Type

[RoHS Compliant]



Model	Rated current AC(A)	Inductance (mH) min.	DC resistance (Ω/line) max.	Temperature rise(K) max.	Weight approx.(g)	
					V	H
SS35V/H-15300	1.5	30	0.48	45	60.0	57.0
SS35V/H-20170	2.0	17	0.28	45	61.0	58.0
SS35V/H-25090	2.5	9	0.20	45	59.0	56.0
SS35V/H-30082	3.0	8.2	0.15	45	59.0	56.0
SS35V/H-35047	3.5	4.7	0.10	45	57.0	54.0
SS35V/H-40033	4.0	3.3	0.08	50	55.0	52.0
SS35V/H-45022	4.5	2.2	0.06	50	53.0	50.0

- Rated voltage:250VAC • Withstanding voltage: 2400VAC (2sec between lines)
- Insulation resistance: at 500VDC, more than 100MΩ (between lines) • Thermal class: E (120°C)
- Operating temperature range (°C): -25 to T (T=120-temperature rise) • Inductance measurement condition: 1kHz, 1V, KC530

Shape and Dimensions

●SS35V

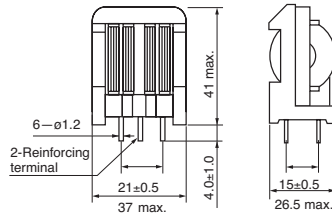

●SS35H

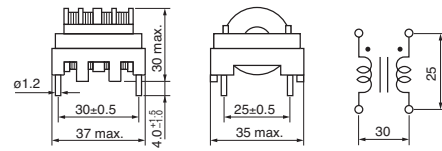

[mm]

Numbering System

SS 35 V - 15 300

① ② ③ ④ ⑤

- Series
- Core size
- Type (V: vertical, H: horizontal)
- Rated current (15 stands for 1.5A)
- Inductance (300 stands for 30mH)

Frequency characteristic

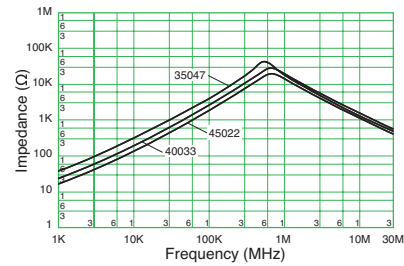
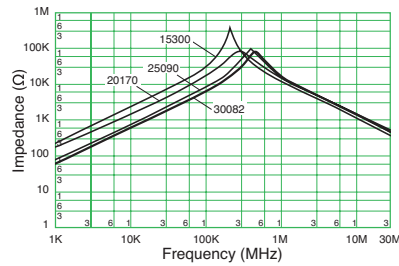

- All specifications in this catalog and production status of products are subject to change without notice. Prior to the purchase, please contact NEC TOKIN for updated product data.
- Please request for a specification sheet for detailed product data prior to the purchase.
- Before using the product in this catalog, please read "Precautions" and other safety precautions listed in the printed version catalog.

SS Coils

SS38V Type

[RoHS Compliant]



Model	Rated current AC(A)	Inductance (mH) min.	DC resistance (Ω/line) max.	Temperature rise(K) max.	Weight approx.(g)
SS38V-35073A	3.5	7.3	0.15	65	66.7
SS38V-38060A	3.8	6.0	0.14	65	65.0
SS38V-40048A	4.0	4.8	0.12	65	62.7
SS38V-43038A	4.3	3.8	0.11	65	60.8

- Rated voltage:250VAC • Withstanding voltage: 2400VAC (2sec between lines)
- Insulation resistance: at 500VDC, more than 100MΩ (between lines) • Thermal class: E (120°C)
- Operating temperature range (°C): -25 to T (T=120-temperature rise) • Inductance measurement condition: 1kHz, 1V, KC530

Shape and Dimensions

●SS38V

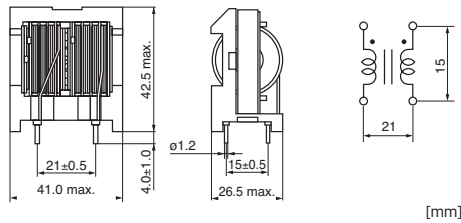

Numbering System

SS 38 V - 35 073A

- ① ② ③ ④ ⑤

- ① Series
- ② Core size
- ③ Type (V: vertical, H: horizontal)
- ④ Rated current (35 stands for 3.5A)
- ⑤ Inductance (073 stands for 7.3mH)

Comparison example with other size product

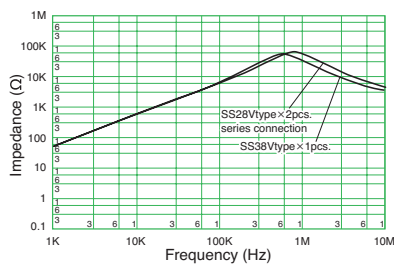

Impedance vs. Frequency

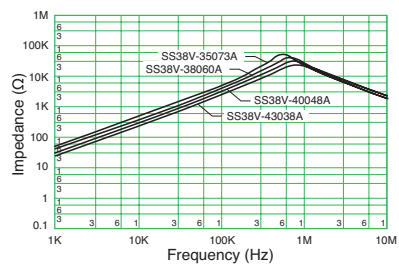

- All specifications in this catalog and production status of products are subject to change without notice. Prior to the purchase, please contact NEC TOKIN for updated product data.
- Please request for a specification sheet for detailed product data prior to the purchase.
- Before using the product in this catalog, please read "Precautions" and other safety precautions listed in the printed version catalog.

SN Coils: Characteristics and Precautions

Material Characteristics of SN Cores

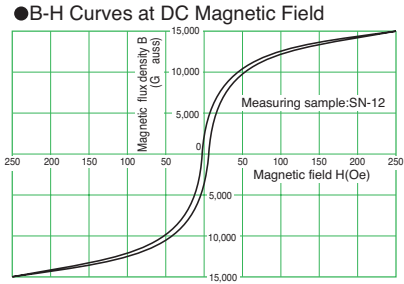
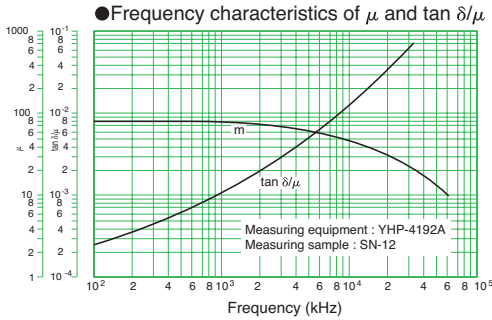

Circuit Design Precautions

Improper use of noise-prevention coils thyristor circuits may cause increased noise. When designing circuits, follow the instructions below.

●Correct insertion of SN Coils and capacitors

SN Coil

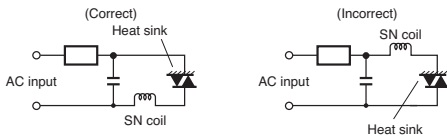

Capacitor

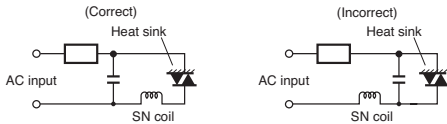

●Correct mounting of SN Coils

When attaching an SN Coil, do not use a long lead or attach it far from the noise emission source. Doing so results in increased aerial radiated noise.

●Circuit for turn-off prevention

When a thyristor control circuit is inserted, the thyristor element may not be able to ignite because the current turns off. To avoid this, inset C and R as shown in figures (A) and (B).

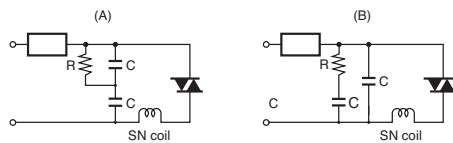

●Appropriate capacity

The appropriate capacity for the capacitor is from $0.1\mu F$ to $0.3\mu F$. If the capacity is too small, the SN Coil perform as expected.

●Effect variation by capacity

As shown in the figure, noise-prevention performance varies with capacitor strength. Select the most appropriate value for your specification.

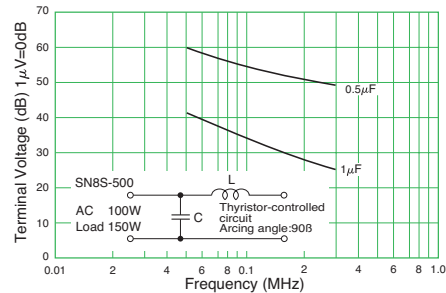

●Use as smoothing choke coils in switching power supplies

SN Coils have a large core loss; Do not use them as smoothing choke coils.

●Precautions

To avoid breaking wires, be sure to glue SN Coils to the board.



- All specifications in this catalog and production status of products are subject to change without notice. Prior to the purchase, please contact NEC TOKIN for updated product data.
- Please request for a specification sheet for detailed product data prior to the purchase.
- Before using the product in this catalog, please read "Precautions" and other safety precautions listed in the printed version catalog.

●Frequency characteristics of μ and $\tan \delta/\mu$

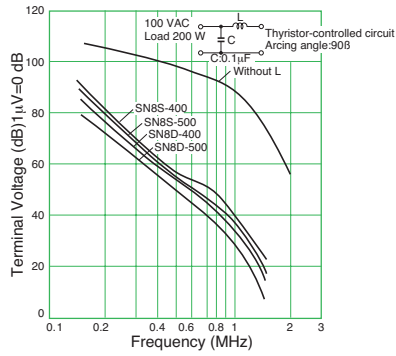

●B-H Curves at DC Magnetic Field

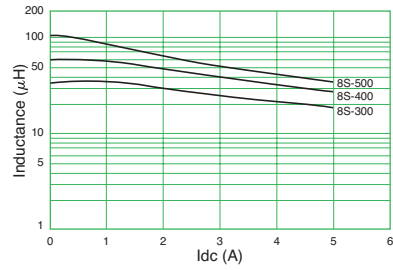

●Frequency characteristics of μ and $\tan \delta/\mu$

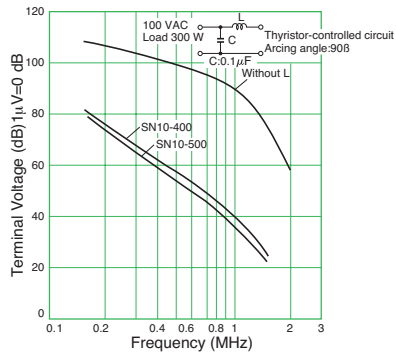

●DC-superposed Characteristics (2)

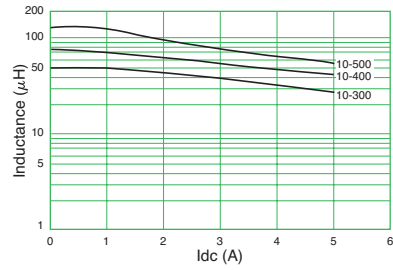

●Frequency characteristics of μ and $\tan \delta/\mu$

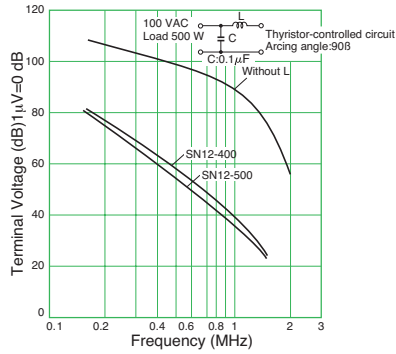

●DC-superposed Characteristics (3)

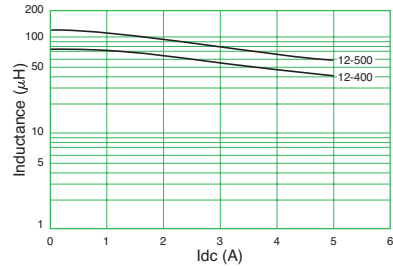

Measuring Circuit

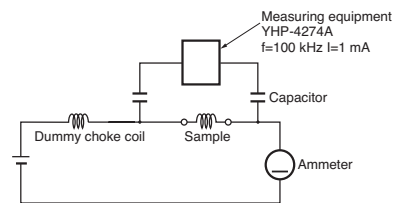

- All specifications in this catalog and production status of products are subject to change without notice. Prior to the purchase, please contact NEC TOKIN for updated product data.
- Please request for a specification sheet for detailed product data prior to the purchase.
- Before using the product in this catalog, please read "Precautions" and other safety precautions listed in the printed version catalog.

HHB Coils

Hi μ and Low Core loss Type

[RoHS Compliant]



- <Features>
- Permeability: 150
 - High permeability realizes compact volume and small footprint.(10 to 50% less volume compared with conventional SN coil series.)
 - Low core loss

Model	Rated current AC(A)	Inductance (μ H) min.	DC resistance (m Ω) max.	Temperature rise(K) max.	Dimensions D×H (mm) max.	ϕ_1 (mm)	ϕ_2 (mm) max.	Wire size (mm ϕ)	Mounting pitch for reference (mm)	Weight approx. (g)
HHB5-0R45A115V	2	115	100	40	13.5×9.5	10±2	1.5	0.45	7	4
HHB8-0R7A100V	3.5	100	70	45	17×10	10±2	1.5	0.7	8	7
HHB10-0R7A550V	3	550	145	45	24×14	10±2	1.5	0.7	10	17
HHB10-0R8A170V	3	170	60	30	23×13	10±2	1.5	0.8	9	12
HHB12-1R2A170V	8	170	40	55	27×14	10±2	1.5	1.2	10.5	22

- Operating temperature range(°C): -25 to T (T=120-temperature rise)
- Wire type: 1 UEW or 1 PEW
- Inductance measurement condition: at 100kHz, 1mA, KC547
- Thermal class: E (120°C)
- Values of mounting pitch listed above are for reference only. The actual pitch may differ.

Shape and Dimensions

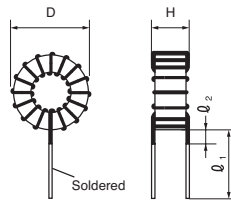

*Same type of shape as SN series are available.(Horizontal type,with base and etc) [mm]

Numbering System

HHB5 - 0R5A 70 V

① ② ③ ④

- ① Core size
- ② Wire size
- ③ Inductance
- ④ shape

Core loss comparison data

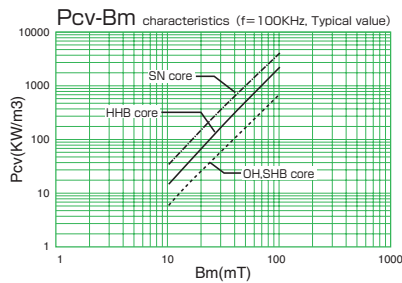

- All specifications in this catalog and production status of products are subject to change without notice. Prior to the purchase, please contact NEC TOKIN for updated product data.
- Please request for a specification sheet for detailed product data prior to the purchase.
- Before using the product in this catalog, please read "Precautions" and other safety precautions listed in the printed version catalog.

Impedance vs. Frequency

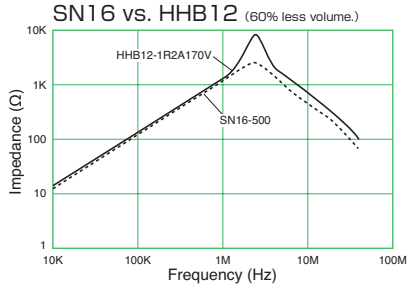
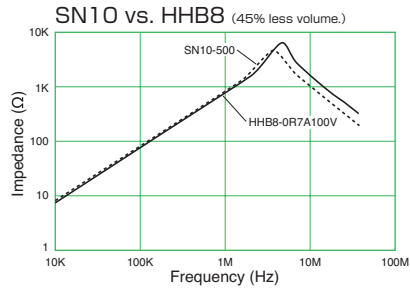
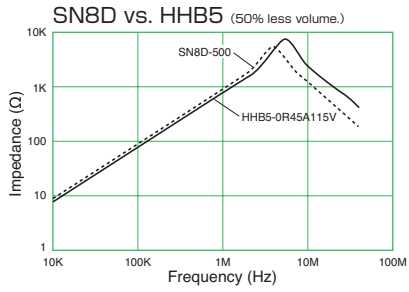

*Comparison of the volume stated in the graph is calculated from guaranteed values.



- All specifications in this catalog and production status of products are subject to change without notice. Prior to the purchase, please contact NEC TOKIN for updated product data.
- Please request for a specification sheet for detailed product data prior to the purchase.
- Before using the product in this catalog, please read "Precautions" and other safety precautions listed in the printed version catalog.

Inductance Characteristics

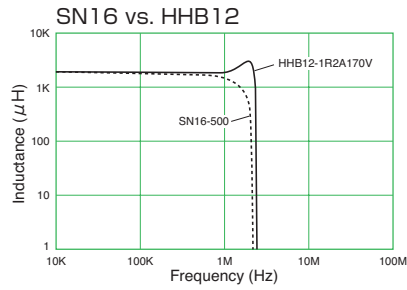
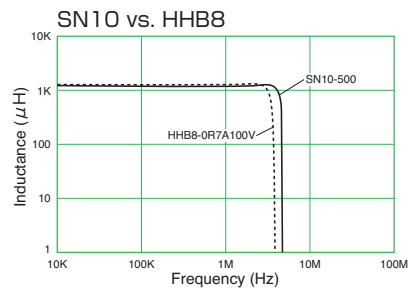
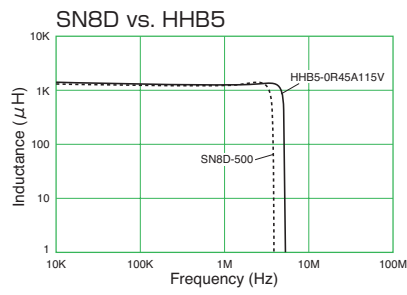

- All specifications in this catalog and production status of products are subject to change without notice. Prior to the purchase, please contact NEC TOKIN for updated product data.
- Please request for a specification sheet for detailed product data prior to the purchase.
- Before using the product in this catalog, please read "Precautions" and other safety precautions listed in the printed version catalog.

DC-superposed Characteristics

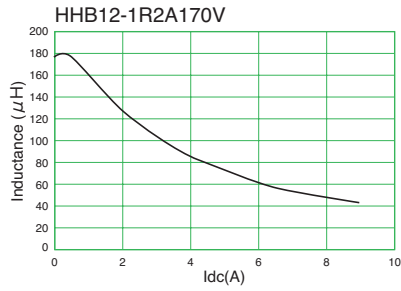
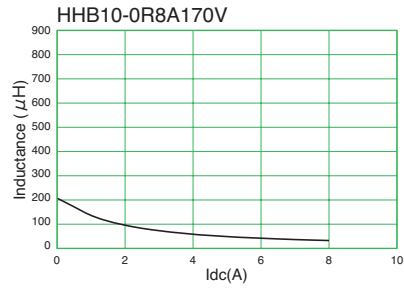
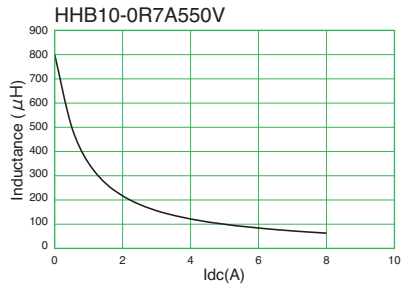
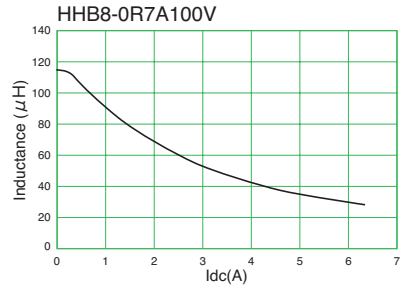
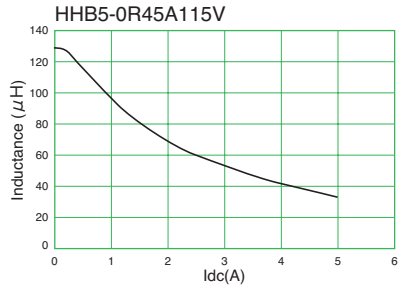

- All specifications in this catalog and production status of products are subject to change without notice. Prior to the purchase, please contact NEC TOKIN for updated product data.
- Please request for a specification sheet for detailed product data prior to the purchase.
- Before using the product in this catalog, please read "Precautions" and other safety precautions listed in the printed version catalog.

SN Coils

Small and Standard Type

[RoHS Compliant]



Type	Model	Rated current (A)	Inductance (μH) min.	DC resistance (Ω) max.	Temperature rise(K) max.	Dimensions D×H (mm) max.	φ ₁ (mm)	φ ₂ (mm) max.	Wire size (mmφ)	Mounting pitch for reference (mm)	Weight approx. (g)
Small type	SN3-200	1	10	0.045	15	8.5×5.5	20±2	1.5	0.4	5	0.8
	SN5-300	2	25	0.042	18	13×7	20±2	1.5	0.55	6	2.6
	SN5-400	2	48	0.058	22	13×8	20±2	1.5	0.55	6	3
	SN8S-300	2	26	0.042	19	16×8	20±2	1.5	0.6	8	4.1
	SN8S-400	2	46	0.052	20	16×8	20±2	1.5	0.6	8	4.5
	SN8S-500	2	72	0.068	23	16×9	20±2	1.5	0.6	8.5	4.9
Standard type	SN8D-300	2	45	0.052	20	16×11	20±2	1.5	0.6	9.5	6.1
	SN8D-400	2	80	0.072	24	16×11	20±2	1.5	0.6	10	6.8
	SN8D-500	2	125	0.100	27	17×13	20±2	1.5	0.6	10.5	7.3
	SN10-300	3	40	0.035	18	21×11	20±2	1.5	0.8	9	10.2
	SN10-400	3	72	0.042	20	21×11	20±2	1.5	0.8	9	10.8
	SN10-500	3	110	0.052	26	21×12	20±2	1.5	0.8	10	11.8
	SN12-400	5	64	0.032	32	25×12	20±2	1.5	1.0	11	15.8
	SN12-500	5	100	0.040	34	26×12	20±2	1.5	1.0	12	18.2
	SN13-300	6	51	0.023	28	30×17	20±2	1.5	1.2	16	31.1
	SN13-400	6	92	0.030	33	30×18	20±2	1.5	1.2	16	35.1
	SN13-500	6	143	0.036	38	31×18	20±2	1.5	1.2	16.5	38.2
	SN16-300	8	60	0.021	21	34×19	20±2	1.5	1.5	15	39
	SN16-400	8	108	0.027	24	35×19	20±2	1.5	1.5	15	44.4
	SN16-500	8	168	0.031	36	35×21	20±2	1.5	1.5	16.5	51.2

- Operating temperature range(°C): -25 to T (T=105-temperature rise)
- Wire type: 1 PVF, 1 UEW or 1 PEW
- Inductance measurement condition: at 100kHz, 1mA, KC547 (SN13 and SN16 types: 1kHz, 1mA)
- Thermal class: A (105°C)

Shape and Dimensions

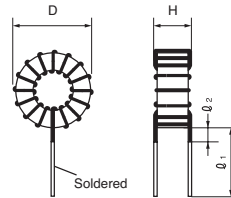

[mm]

Impedance vs. Frequency

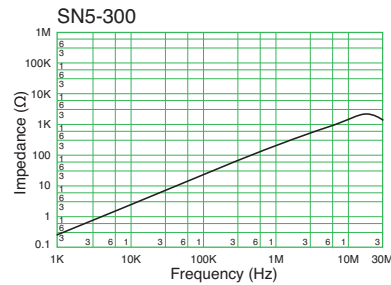
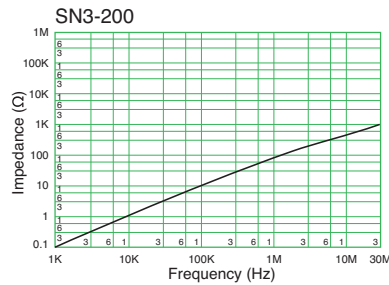

- All specifications in this catalog and production status of products are subject to change without notice. Prior to the purchase, please contact NEC TOKIN for updated product data.
- Please request for a specification sheet for detailed product data prior to the purchase.
- Before using the product in this catalog, please read "Precautions" and other safety precautions listed in the printed version catalog.

Impedance vs. Frequency

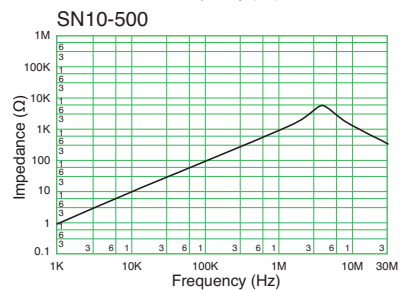
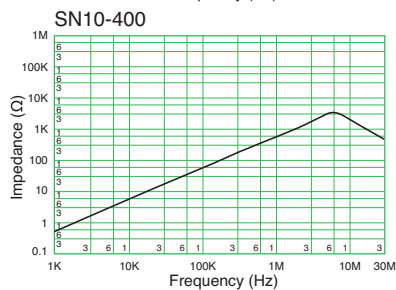
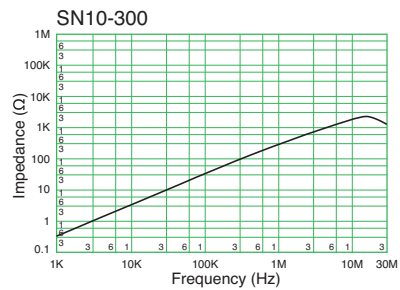
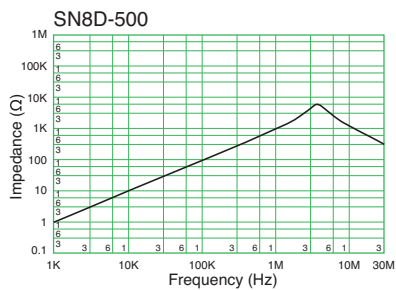
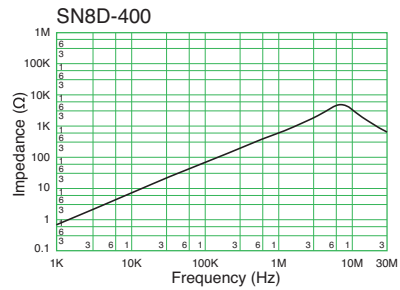
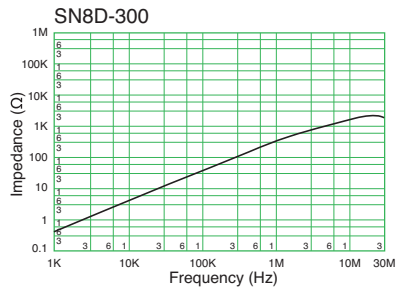
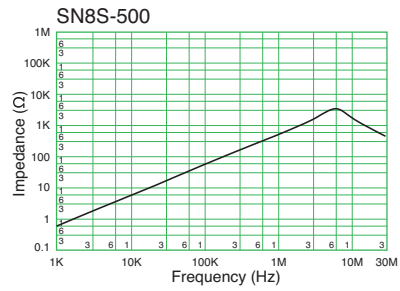
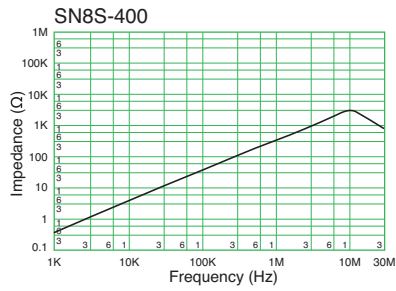
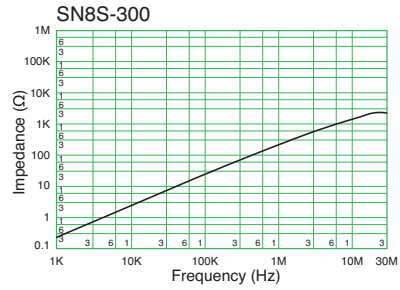
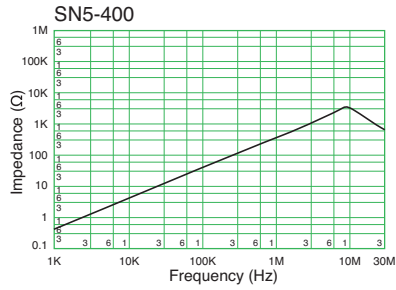

AC Line Filters



- All specifications in this catalog and production status of products are subject to change without notice. Prior to the purchase, please contact NEC TOKIN for updated product data.
- Please request for a specification sheet for detailed product data prior to the purchase.
- Before using the product in this catalog, please read "Precautions" and other safety precautions listed in the printed version catalog.

Impedance vs. Frequency

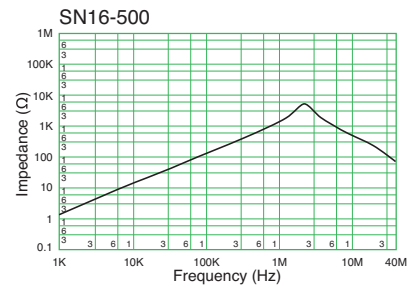
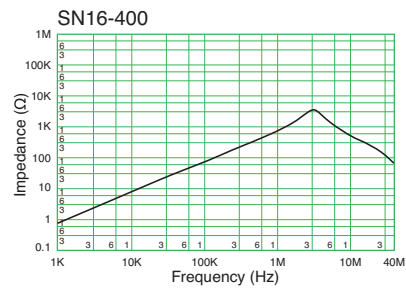
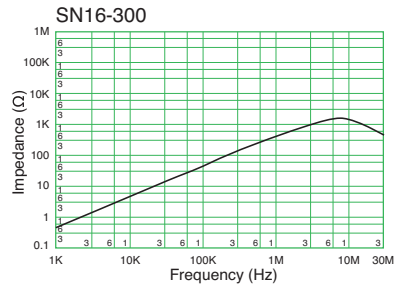
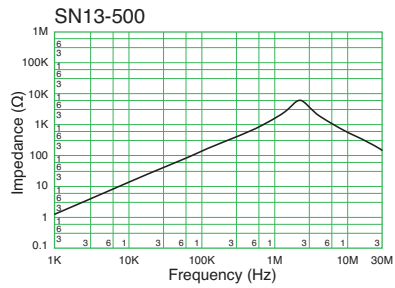
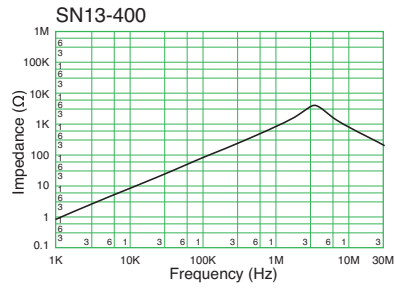
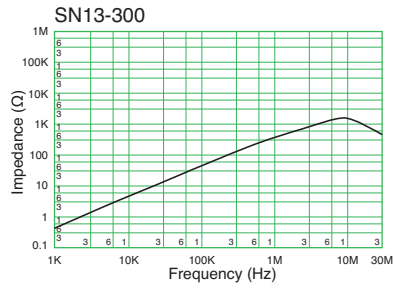
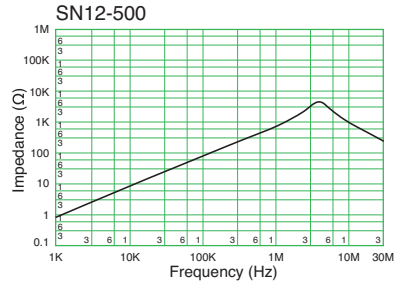
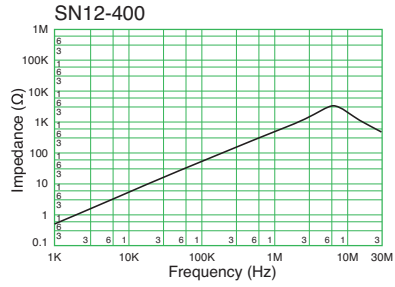

- All specifications in this catalog and production status of products are subject to change without notice. Prior to the purchase, please contact NEC TOKIN for updated product data.
- Please request for a specification sheet for detailed product data prior to the purchase.
- Before using the product in this catalog, please read "Precautions" and other safety precautions listed in the printed version catalog.

SN Coils

Terminal Base Type – J Type

[RoHS Compliant]



Model	Rated current (A)	Inductance (μH) min.	DC resistance (Ω) max.	Temperature rise(K) max.	Finished dimensions (mm)			Wire size (mmφ)	Weight approx. (g)
					A(max.)	B(max.)	C(max.)		
SN10-300J	3	40	0.041	23	23	16	26	0.8	12.5
SN10-400J	3	72	0.056	27	23	16	26	0.8	12.9
SN10-500J	3	110	0.071	30	23	16	26	0.8	14
SN12-400J	5	64	0.037	35	28	17	29	1.0	17.1
SN12-500J	5	100	0.045	38	28	17	29	1.0	20

- Operating temperature range(°C): -25 to T (T=105-temperature rise)
- Wire type: 1 PVF, 1 UEW or 1 PEW
- Inductance measurement condition: at 100kHz, 1mA, KC547
- Thermal class: A (105°C)

Shape and Dimensions

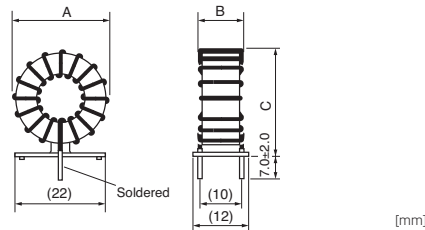

Frequency characteristic

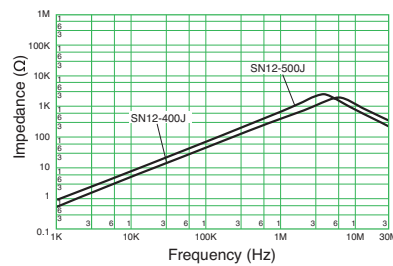
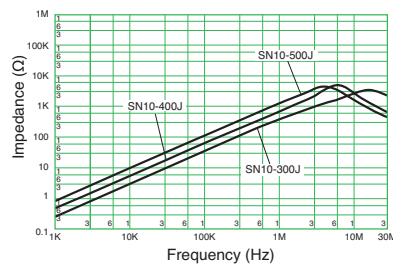

- All specifications in this catalog and production status of products are subject to change without notice. Prior to the purchase, please contact NEC TOKIN for updated product data.
- Please request for a specification sheet for detailed product data prior to the purchase.
- Before using the product in this catalog, please read "Precautions" and other safety precautions listed in the printed version catalog.

SN Coils

Terminal Base Type – JA Type

[RoHS Compliant]



Model	Rated current (A)	Inductance (μH) min.	DC resistance (Ω) max.	Temperature rise(K) max.	Finished dimensions (mm)			Wire size (mmφ)	Weight approx. (g)
					A(max.)	B(max.)	C(max.)		
SN8S-300JA	2	26	0.042	19	18.0	—	18.0	0.6	4.4
SN8S-400JA	2	46	0.052	20	18.0	—	18.0	0.6	5
SN16-300JA	8	60	0.021	21	35.0	19.0	39.0	1.5	40.6
SN16-400JA	8	108	0.027	24	35.0	20.0	39.0	1.5	45
SN16-500JA	8	168	0.031	36	35.0	21.0	39.0	1.5	53.6

- Operating temperature range(°C): -25 to T (T=105-temperature rise) • Wire type: 1 PVF, 1 UEW or 1 PEW
- Inductance measurement condition: at 100kHz, 1mA, KC547 • Thermal class: A (105°C)

Shape and Dimensions

●SN8S-JA

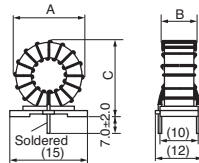

●SN16-JA

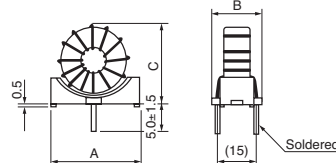

[mm]

Frequency characteristic

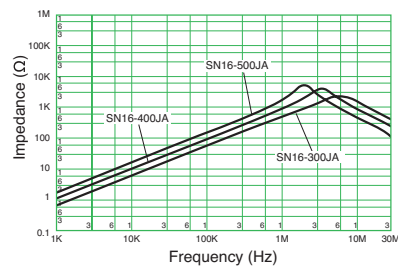
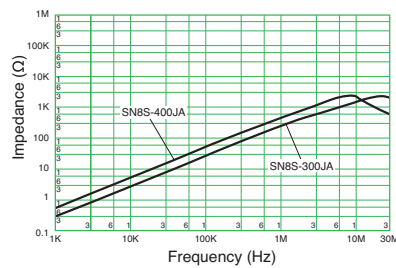

- All specifications in this catalog and production status of products are subject to change without notice. Prior to the purchase, please contact NEC TOKIN for updated product data.
- Please request for a specification sheet for detailed product data prior to the purchase.
- Before using the product in this catalog, please read "Precautions" and other safety precautions listed in the printed version catalog.

SN Coils

Terminal Base Type – JB Type

[RoHS Compliant]

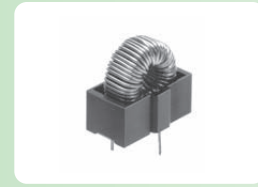

Model	Rated current (A)	Inductance (μH) min.	DC resistance (Ω) max.	Temperature rise(K) max.	Finished dimensions (mm)					Wire size (mmφ)	Weight approx. (g)
					A(max.)	B(max.)	C(max.)	D	E		
SN5-300JB	1	25	0.080	18	13.5	9.2	15.0	(7.5)	(10.0)	0.4	3
SN5-450JB	1	64	0.110	25	13.5	9.2	15.5	(7.5)	(10.0)	0.4	3
SN8S-300JB	2	26	0.055	19	18.0	12.5	18.0	(9.7)	(14.0)	0.6	4.8
SN8S-400JB	2	46	0.070	20	18.0	12.5	18.0	(9.7)	(14.0)	0.6	5.4
SN8S-500JB	2	72	0.085	23	18.0	12.5	18.0	(9.7)	(14.0)	0.6	5.9
SN8D-300JB	2	45	0.070	20	18.5	15.5	18.0	(13.0)	(14.0)	0.6	7.6
SN8D-400JB	2	80	0.085	24	18.5	15.5	18.0	(13.0)	(14.0)	0.6	8.4
SN8D-500JB	2	125	0.100	27	18.5	15.5	18.0	(13.0)	(14.0)	0.6	8.7

- Operating temperature range(°C): -25 to T (T=105-temperature rise)
- Wire type: 1 PVF, 1 UEW or 1 PEW
- Inductance measurement condition: at 100kHz, 1mA, KC547
- Thermal class: A (105°C)

Shape and Dimensions

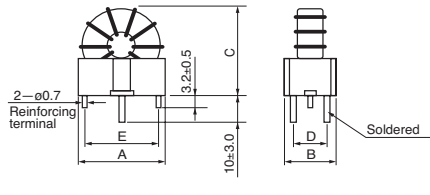

Frequency characteristic

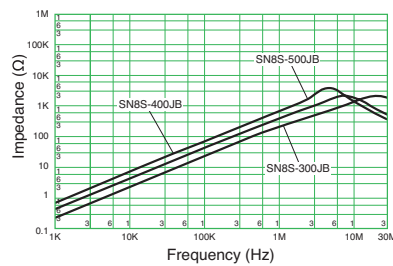
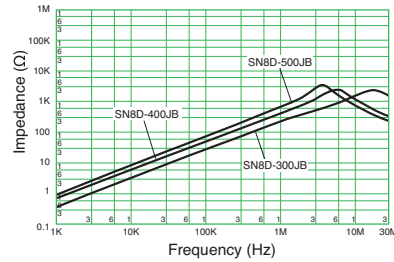
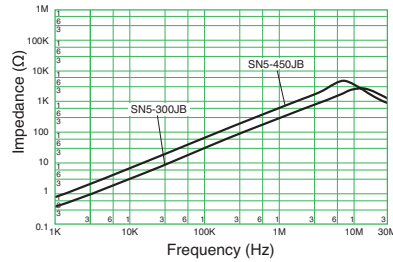

- All specifications in this catalog and production status of products are subject to change without notice. Prior to the purchase, please contact NEC TOKIN for updated product data.
- Please request for a specification sheet for detailed product data prior to the purchase.
- Before using the product in this catalog, please read "Precautions" and other safety precautions listed in the printed version catalog.

SN Coils

Terminal Base Type – W Type

[RoHS Compliant]



Model	Rated current (A)	Inductance (μH) min.	DC resistance (Ω) max.	Temperature rise(K) max.	Finished dimensions (mm)			Wire size (mmφ)	Weight approx. (g)
					A(max.)	B(max.)	C(max.)		
SN8D-300W	2	45	0.052	20	24.5	18	19.5	0.6	15.1
SN8D-400W	2	80	0.072	24	24.5	18	19.5	0.6	15.4
SN8D-500W	2	125	0.100	27	24.5	18	19.5	0.6	17

- Operating temperature range(°C): -25 to T (T=105-temperature rise) • Wire type:1 PVF, 1 UEW or 1 PEW
- Inductance measurement condition: at 100kHz, 1mA, KC547 • Thermal class: A (105°C)

Shape and Dimensions

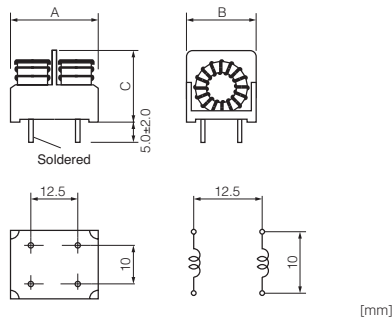

Frequency characteristic

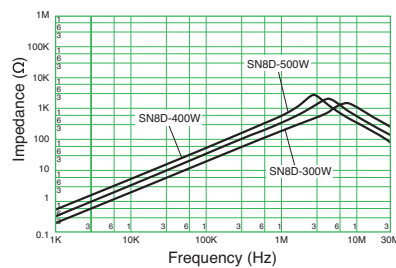

- All specifications in this catalog and production status of products are subject to change without notice. Prior to the purchase, please contact NEC TOKIN for updated product data.
- Please request for a specification sheet for detailed product data prior to the purchase.
- Before using the product in this catalog, please read "Precautions" and other safety precautions listed in the printed version catalog.

SN Coils

Terminal Base Type – P1 Type

[RoHS Compliant]



Model	Rated current (A)	Inductance (μH) min.	DC resistance (Ω) max.	Temperature rise(K) max.	Finished dimensions (mm)			Wire size (mmφ)	Weight approx. (g)
					A(max.)	B(max.)	C(max.)		
SN8S-30P1	2	26	0.042	19	17	11	23	0.6	5
SN8S-40P1	2	46	0.052	20	17	11	23	0.6	5.2
SN8S-50P1	2	72	0.068	23	17	11	23	0.6	5.5

- Operating temperature range(°C): -25 to T (T=105-temperature rise) • Wire type:1 PVF, 1 UEW or 1 PEW
- Inductance measurement condition: at 100kHz, 1mA, KC547 • Thermal class: A (105°C)

Shape and Dimensions

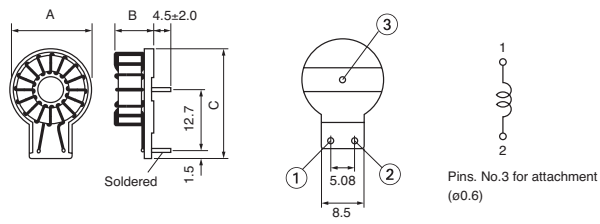

Frequency characteristic

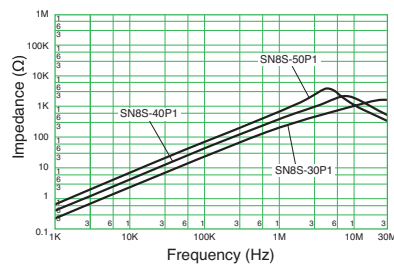

- All specifications in this catalog and production status of products are subject to change without notice. Prior to the purchase, please contact NEC TOKIN for updated product data.
- Please request for a specification sheet for detailed product data prior to the purchase.
- Before using the product in this catalog, please read "Precautions" and other safety precautions listed in the printed version catalog.

SN Coils

Terminal Base Type – P2 Type

[RoHS Compliant]



Model	Rated current (A)	Inductance (μH) min.	DC resistance (Ω) max.	Temperature rise(K) max.	Finished dimensions (mm)				Wire size (mmφ)	Weight approx. (g)
					A(max.)	B(max.)	C(max.)	D(max.)		
SN5-30P2	2	25	0.046	18	17.0	14.0	9.0	12.7	0.55	3
SN5-40P2	2	48	0.065	22	17.0	14.0	9.0	12.7	0.55	3.5
SN8S-30P2	2	26	0.050	19	19.0	17.0	10.5	15.2	0.6	5
SN8S-40P2	2	46	0.060	20	19.0	17.0	10.5	15.2	0.6	5.2
SN8S-50P2	2	72	0.075	23	19.0	17.0	10.5	15.2	0.6	5.5

- Operating temperature range(°C): -25 to T (T=105-temperature rise) • Wire type: 1 PVF, 1 UEW or 1 PEW
- Inductance measurement condition: at 100kHz, 1mA, KC547 • Thermal class: A (105°C)

Shape and Dimensions

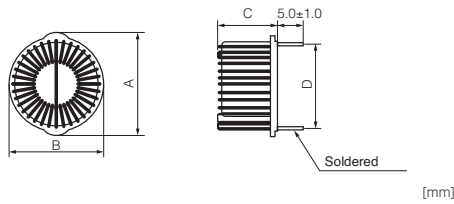

Frequency characteristic

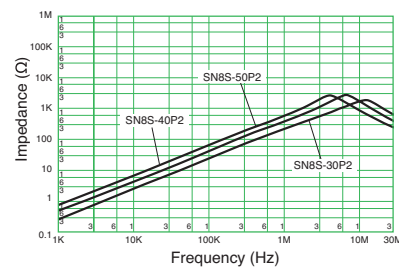
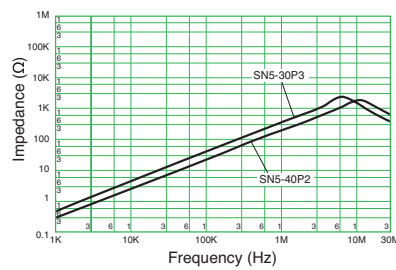

- All specifications in this catalog and production status of products are subject to change without notice. Prior to the purchase, please contact NEC TOKIN for updated product data.
- Please request for a specification sheet for detailed product data prior to the purchase.
- Before using the product in this catalog, please read "Precautions" and other safety precautions listed in the printed version catalog.

SHB Coils

Booster Coils for Active Filters

[RoHS Compliant]



Model	Rated current (A)	Inductance(μ H)		DC resistance (m Ω) max.	Dimensions D×H (mm) max.	Wire size (mm ϕ)	Weight approx. (g)
		I=0 \pm 20%	I=rated min.				
SHB-02-1000V	2	1640	750	450	35×20	0.6	40
SHB-03-500V	3	850	375	180	32×20	0.8	45
SHB-03-700V	3	1150	525	230	43×22	0.8	65
SHB-04-300V	4	600	225	123	35×20	0.9	45
SHB-04-500V	4	950	375	170	40×22	0.9	65
SHB-05-300V	5	680	225	98	43×22	1.1	70
SHB-05-650V	5	1330	488	150	53×30	1.1	120
SHB-08-150V	8	440	113	58	43×22	1.3	75
SHB-08-350V	8	930	263	100	53×30	1.3	125
SHB-08-650V	8	1170	488	104	56×33	1.3	205
SHB-10-200V	10	570	150	50	53×30	1.6	135
SHB-10-400V	10	700	300	50	56×33	1.6	215
SHB-15-100V	15	400	75	33	53×30	1.8	135
SHB-15-200V	15	400	150	35	57×33	1.8	210
SHB-20-35V	20	74	26	12	53×30	1.1×4	115
SHB-20-60V	20	105	45	15	60×33	1.1×4	195
SHB-30-17V	30	36	13	7	53×30	1.4×4	120
SHB-30-20V	30	44	15	7	60×33	1.4×4	200

- Operating temperature range(°C): -25 to T (T=105-temperature rise) • Wire type:1 PVF, 1 UEW or 1 PEW
- Inductance measurement condition: at 100kHz, 1mA, KC547 • Thermal class: A (105°C)

Shape and Dimensions

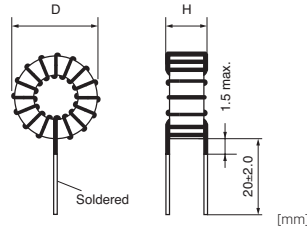

Frequency characteristic

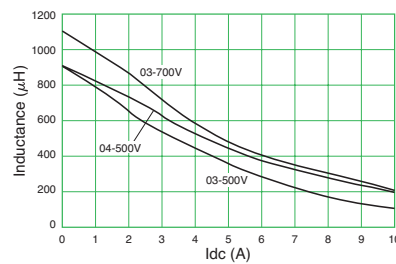
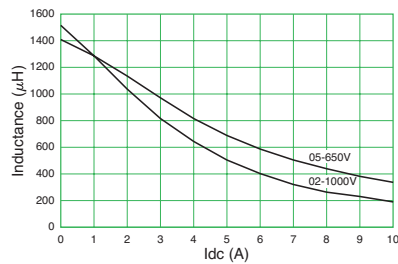

- All specifications in this catalog and production status of products are subject to change without notice. Prior to the purchase, please contact NEC TOKIN for updated product data.
- Please request for a specification sheet for detailed product data prior to the purchase.
- Before using the product in this catalog, please read "Precautions" and other safety precautions listed in the printed version catalog.

DC-superposed Characteristics

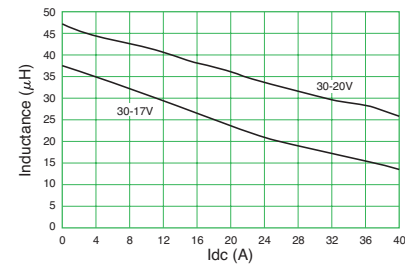
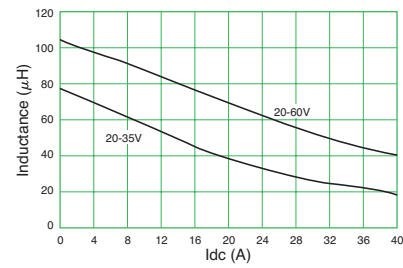
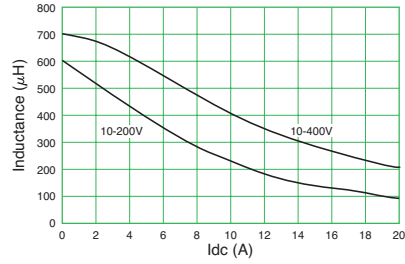
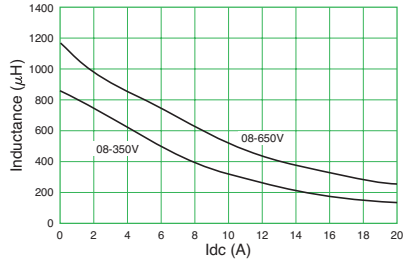
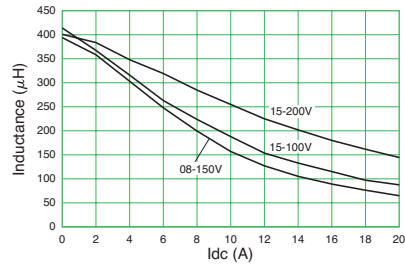
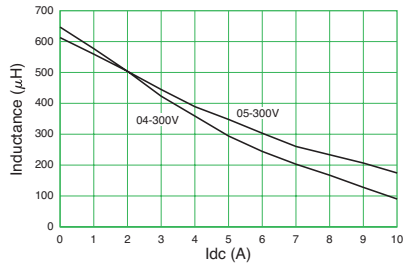

- All specifications in this catalog and production status of products are subject to change without notice. Prior to the purchase, please contact NEC TOKIN for updated product data.
- Please request for a specification sheet for detailed product data prior to the purchase.
- Before using the product in this catalog, please read "Precautions" and other safety precautions listed in the printed version catalog.

Precautions

Shelf Life

Use within 6 months. If the product is used after a storage period of 6 months or longer, confirm its solderability before use.

Precautions for product storage

Storage condition

- Avoid storage in high temperature and high humidity environment as such condition may deteriorate the solderability of external electrode.
- Avoid storage in atmosphere containing toxic gasses or acid (e.g. sulfur and chlorine) as such gas may deteriorate the solderability of external electrode.
- Avoid storage near strong magnetic field as such condition may magnetize the product.



- All specifications in this catalog and production status of products are subject to change without notice. Prior to the purchase, please contact NEC TOKIN for updated product data.
- Please request for a specification sheet for detailed product data prior to the purchase.
- Before using the product in this catalog, please read "Precautions" and other safety precautions listed in the printed version catalog.

Precautions



- The names of the products and the specifications in this catalog are subject to change without notice for the sake of improvement. The manufacturer also reserves the right to discontinue any of these products. At the time of delivery, please ask for specifications sheets to check the contents in order to use the products properly and safely.
- Descriptions in this catalog regarding product characteristics and quality are based solely on discrete components. When using these components, be sure to check the specifications with the component in question mounted on the products.
- The manufacturer's warranty will not cover any disadvantage or damage caused by improper use of the products that deviates from the characteristics, specifications, or conditions for use described in this catalog.
- The products in this catalog are intended for use in ordinary electronic products. If any of these products are to be used in special applications requiring extremely high reliability, such as in aviation equipment and nuclear power controllers where product defects might pose a safety risk, please consult your NEC TOKIN sales representatives.
- Though the manufacturer has taken all possible precautions to ensure the quality and reliability of its products, improper use of products may result in bodily injury, fire, or similar accident. If you have any questions regarding the use of the products in question, please consult your NEC TOKIN sales representatives.
- Please be advised that the manufacturer accepts no responsibility for any infraction by users of the manufacturer's products on third party patents or industrial copyrights. The manufacturer is responsible only when such infractions are attributable to the structural design of the product and its manufacturing process.
- Export Control
For customers outside Japan
NEC TOKIN products should not be used or sold for use in the development, production, stockpiling or utilization of any conventional weapons or mass-destructive weapons(nuclear weapons, chemical or biological weapons, or missiles), or any other weapons.
For customers in Japan
For products which are controlled items subject to the "Foreign Exchange and Foreign Trade Law" of Japan, the export license specified by the law is required for export.
- This catalog is current as of June 2012.



- All specifications in this catalog and production status of products are subject to change without notice. Prior to the purchase, please contact NEC TOKIN for updated product data.
- Please request for a specification sheet for detailed product data prior to the purchase.
- Before using the product in this catalog, please read "Precautions" and other safety precautions listed in the printed version catalog.