

IEC Appliance Inlet C14 with Filter, Fuseholder 1- or 2-pole (5x20 mm or 6.3x32 mm), Line Switch 1- or 2-pole, Voltage Selector (Step)

Standard- or Medical-Filter



Fuse drawer must be ordered separately (see accessories).



Description

- Panel Mount:
Screw-on mounting from front side
- 5 Functions:
Appliance Inlet, Line Switch, Fuseholder with interchangeable fuse drawer for Fuse-links 5 x 20 mm or 6.3 x 32 mm, with or without voltage selector (step switch), Line filter in standard and medical version
- Quick connect terminals 4.8 x 0.8 mm
- Alternative: version without line filter [KD](#)

Approvals

- VDE License Number: 40004665 (FKSO, FKSP, FKSU, FKSV)
- UL License Number: E72928 (FKSO, FKSP, FKSU, FKSV)

Characteristics

- All single elements are already wired
- The fuse drawer "Fingergrip" can be removed by hand
For added safety "Extra-Safe" fuse drawers are available
Fuse drawer meets requirements of medical standard IEC/EN 60601-1
The fuse drawer can only be opened with the aid of a tool
The fuseholder is accessible from the equipment front
- Qualified for use in equipment according IEC/EN 60950

References

[General Product Information](#)

Weblinks

[Approvals](#), [RoHS](#), [CHINA-RoHS](#), [Mating Connectors](#), [e-Store](#), [Distributor-Stock-Check](#), [Accessories](#)

Technical Data

Ratings IEC	1 - 10A @ Ta 40 °C / 250VAC; 50Hz
Ratings UL/CSA	1 - 10A @ Ta 40 °C / 125VAC; 60Hz
Leakage Current	standard < 0.5 mA (250 V / 60Hz) medical < 5 µA (250 V / 60 Hz)
Dielectric Strength	> 1.7 kVDC between L-N > 2.7 kVDC between L/N-PE Test voltage (2 sec)
Allowable Operation Temp.	-25 °C to 85 °C
Climatic Category	25/085/21 acc. to IEC 60068-1
Degree of Protection	from front side IP 40 acc. to IEC 60529
Protection Class	Suitable for appliances with protection class 1 acc. to IEC 61140
Terminal	Quick connect terminals 4.8 x 0.8 mm
Panel Thickness s	Screw: max 8 mm Mounting screw torque max 0.5 Nm
Material: Housing	Thermoplastic, black, UL 94V-0

Appliance-Inlet/-Outlet	C14 acc. to IEC/EN 60320-1, UL 498, CSA C22.2 no. 42 (for cold conditions) pin-temperature 70 °C, 10A, Protection Class 1
Fuseholder	1 or 2 pole, Shocksafe category PC2 acc. to IEC 60127-6, for fuse-links 5 x 20 or 6.3 x 32 mm
Rated Power Acceptance @ Ta 23 °C	5 x 20: 2.5W (1 pole)/ 2W (2-pole) per pole 6.3 x 32: 3.15W (1 pole)/ 2.5W (2-pole) per pole
Power Acceptance @ Ta > 23°C	Admissible power acceptance at higher ambient temperature see derating curves
Line Switch	Rocker switch 2-pole, non-illuminated, acc. to IEC 61058-1 Technical details
Voltage Selectors	optional, step, 2-4 digits
Line Filter	Standard and Medical Version, IEC 60939, IEC 60601-1, UL 1283, UL 544, EN 133 200, CSA C22.2 no. 8 Technical details
MTBF	> 1'200'000h acc. to MIL-HB-217 F

Dimensions CD

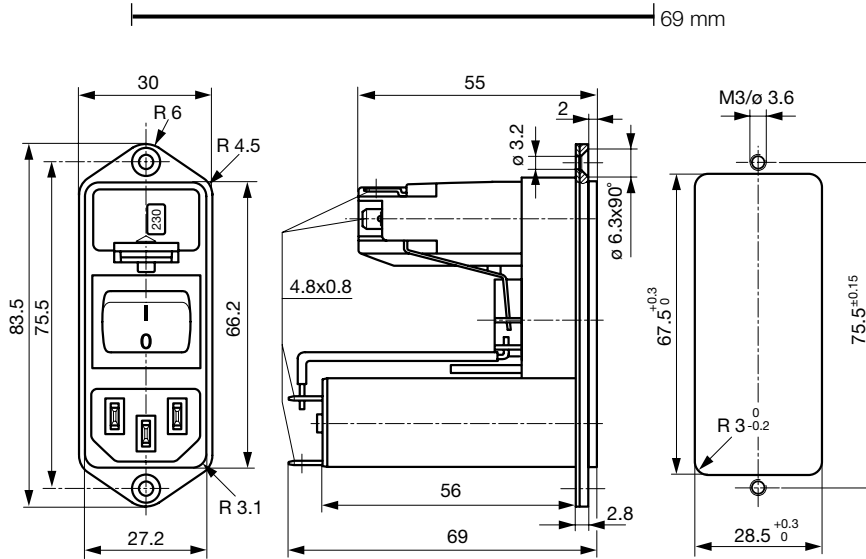

Technical Data of Filter-Components

Rated Current [A]	Filter-Type	Inductances L [mH]	Capacitance CX [nF]	Capacitance CY [nF]	R [MΩ]
1	Standard Version	2 x 10	68	2.2	-
2	Standard Version	2 x 4	68	2.2	-
4	Standard Version	2 x 1.5	68	2.2	-
6	Standard Version	2 x 0.8	68	2.2	-
10	Standard Version	2 x 0.3	68	2.2	-
1	Medical Version (M5)	2 x 10	68	-	1
2	Medical Version (M5)	2 x 4	68	-	1
4	Medical Version (M5)	2 x 1.5	68	-	1
6	Medical Version (M5)	2 x 0.8	68	-	1
10	Medical Version (M5)	2 x 0.3	68	-	1

Diagrams

Standard version with voltage selector

Medical version with voltage selector

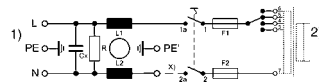
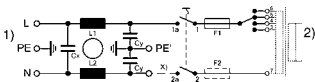

- 1) Line
- 2) Load
- x) External connection to be made by the customer

- 1) Line
- 2) Load
- x) External connection to be made by the customer

Derating Curves

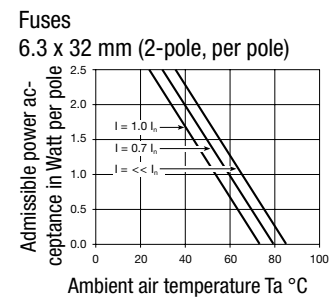
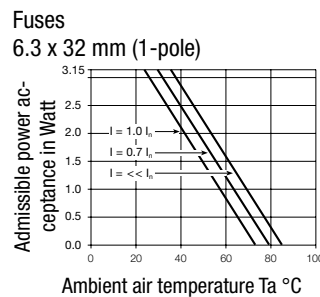
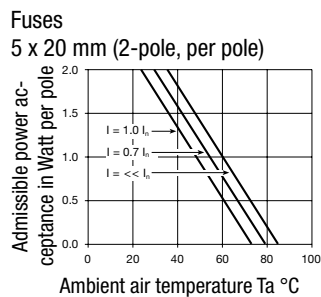
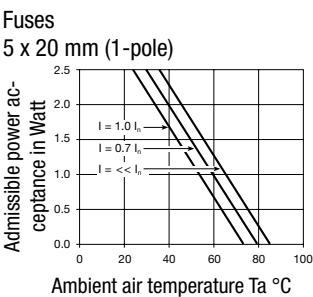

Attenuation Loss

--- differential mode ____ common mode

Standard version

1 A

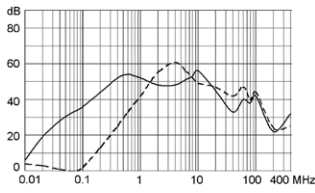

2 A

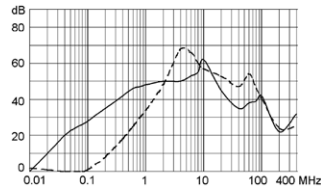

4 A

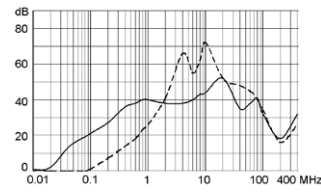

6 A

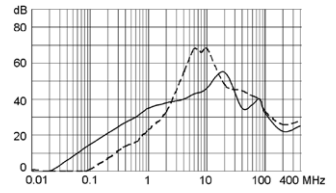

10 A

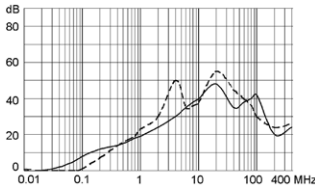

Medical version (M5)

1 A

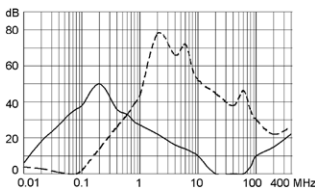

2 A

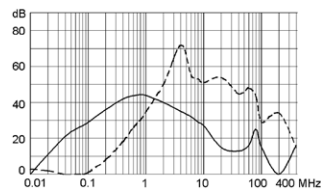

4 A

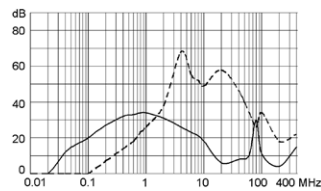

6 A

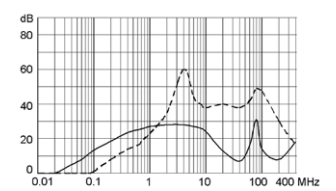

10 A

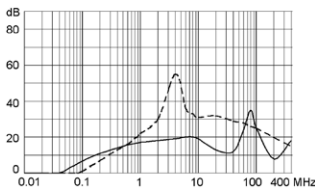

Variants

Type	Rated Current [A]	Filter-Type	Fuseholder	Line Switch	Voltage Selectors	Order Number
CD	1	Standard Version	1-pole	2-pole	-	CD11.1501.151
CD	2	Standard Version	1-pole	2-pole	-	CD21.1501.151
CD	4	Standard Version	1-pole	2-pole	-	CD31.1501.151
CD	6	Standard Version	1-pole	2-pole	-	CD41.1501.151
CD	10	Standard Version	1-pole	2-pole	-	CD61.1501.151
CD	1	Standard Version	1-pole	2-pole	2-4 digits	CD11.4501.151
CD	2	Standard Version	1-pole	2-pole	2-4 digits	CD21.4501.151
CD	4	Standard Version	1-pole	2-pole	2-4 digits	CD31.4501.151
CD	6	Standard Version	1-pole	2-pole	2-4 digits	CD41.4501.151
CD	10	Standard Version	1-pole	2-pole	2-4 digits	CD61.4501.151
CD	1	Standard Version	2-pole	2-pole	-	CD14.1101.151
CD	2	Standard Version	2-pole	2-pole	-	CD24.1101.151
CD	4	Standard Version	2-pole	2-pole	-	CD34.1101.151
CD	6	Standard Version	2-pole	2-pole	-	CD44.1101.151
CD	10	Standard Version	2-pole	2-pole	-	CD64.1101.151
CD	1	Standard Version	2-pole	2-pole	2-4 digits	CD14.4101.151
CD	2	Standard Version	2-pole	2-pole	2-4 digits	CD24.4101.151
CD	4	Standard Version	2-pole	2-pole	2-4 digits	CD34.4101.151

Type	Rated Current [A]	Filter-Type	Fuseholder	Line Switch	Voltage Selectors	Order Number
CD	6	Standard Version	2-pole	2-pole	2-4 digits	CD44.4101.151
CD	10	Standard Version	2-pole	2-pole	2-4 digits	CD64.4101.151
CD	1	Medical Version (M5)	2-pole	2-pole	2-4 digits	CDG4.4101.151
CD	2	Medical Version (M5)	2-pole	2-pole	2-4 digits	CDA4.4101.151
CD	4	Medical Version (M5)	2-pole	2-pole	2-4 digits	CDC4.4101.151
CD	6	Medical Version (M5)	2-pole	2-pole	2-4 digits	CDE4.4101.151
CD	10	Medical Version (M5)	2-pole	2-pole	2-4 digits	CDL4.4101.151

Packaging unit 10 Pcs

Required Accessory

Description

Fusedrawer 3

Fusedrawer for Fuse Links 5x20mm resp.. 6.3x32mm



Fingergrip, 5 x 20, 2-pole, Voltage Selectors	4303.2014.00
Fingergrip, 5 x 20, 2-pole, Voltage Selectors, 100, 120, 220, 240	4303.2014.01
Fingergrip, 5 x 20, 2-pole, Voltage Selectors, 110, 150, 220	4303.2014.02
Fingergrip, 5 x 20, 2-pole, Voltage Selectors, 110, 220	4303.2014.03

...

Accessories

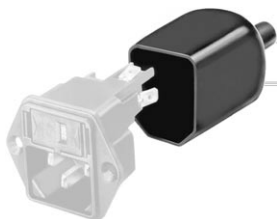

Assorted Covers

Rear Cover

0859.0077



Cord retaining kits

Cord retaining strain relief

Flat head, A

4700.0001

Mating Outlets/Connectors

Category / Description

Appliance Outlet Overview complete



IEC Appliance Outlet F, Screw-on Mounting, Front Side, Solder or Quick-connect Terminal	4787
IEC Appliance Outlet F, Snap-in Mounting, Front Side, Solder or Quick-connect Terminal	4788
IEC Appliance Outlet F or H, Screw-on Mounting, Front Side, Solder, PCB or Quick-connect Terminal	5091
IEC Appliance Outlet F or H, Screw-on Mounting, Front Side, Solder or Quick-connect Terminal	5092

[Appliance Outlet further types to CD](#)



[Connector Overview complete](#)

IEC Connector C15, Rewireable, Straight	0101
IEC Connector C15A, Rewireable, Straight	0102
IEC Connector C15A, Rewireable, Straight	0102-G
IEC Connector C15A, Rewireable, Angled	0112
IEC Connector C13, Rewireable, Angled	4012
Connector further types to CD	...

[Power Cord Overview complete](#)



Power Cord with IEC Connector C13, Angled	0311
Power Cord with IEC Connector C13, Angled	3011
Power Cord with IEC Connector C13, Angled	3012
Power Cord with IEC Connector C13, Angled	3013
Power Cord with IEC Connector C13	3020
Power Cord further types to CD	...