



Frontier Electronics Corp.

667 E. COCHRAN STREET, SIMI VALLEY, CA 93065

TEL: (805) 522-9998 FAX: (805) 522-9989

E-mail: frontiersales@frontierusa.com

Web: <http://www.frontierusa.com>

1A ULTRA FAST EFFICIENT RECTIFIER

MUR105 THRU MUR1100

FEATURES

- LOW POWER LOSS, HIGH EFFICIENCY
- LOW LEAKAGE
- LOW FORWARD VOLTAGE DROP
- HIGH CURRENT CAPABILITY
- HIGH SPEED SWITCHING
- HIGH RELIABILITY
- HIGH CURRENT SURGE
- GLASS PASSIVATED CHIP JUNCTION

MECHANICAL DATA

- CASE: MOLDED PLASTIC, DO41, DIMENSIONS IN INCHES AND (MILLIMETERS)
- EPOXY: UL 94V-0 RATE FLAME RETARDANT
- LEAD: MIL-STD-202E METHOD 208C GUARANTEED
- MOUNTING POSITION: ANY
- WEIGHT: 0.34 GRAMS

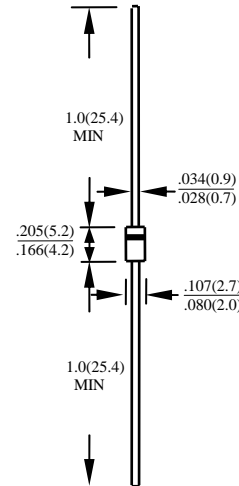

MAXIMUM RATINGS AND ELECTRICAL CHARACTERISTICS RATINGS AT 25°C AMBIENT TEMPERATURE UNLESS OTHERWISE SPECIFIED SINGLE PHASE, HALF WAVE, 60 HZ, RESISTIVE OR INDUCTIVE LOAD. FOR CAPACITIVE LOAD, DERATE CURRENT BY 20%

RATINGS	SYMBOL	MUR 105	MUR 110	MUR 115	MUR 120	MUR 140	MUR 160	MUR 180	MUR 1100	UNITS
MAXIMUM RECURRENT PEAK REVERSE VOLTAGE	V_{RRM}	50	100	150	200	400	600	800	1000	V
MAXIMUM RMS VOLTAGE	V_{RMS}	35	70	105	140	280	480	560	700	V
MAXIMUM DC BLOCKING VOLTAGE	V_{DC}	50	100	150	200	400	600	800	1000	V
MAXIMUM AVERAGE FORWARD RECTIFIED CURRENT 0.375" (9.5mm) LEAD LENGTH AT $T_A=55^\circ\text{C}$	I_O	1.0								A
PEAK FORWARD SURGE CURRENT, 8.3ms SINGLE HALF SINE-WAVE SUPERIMPOSED ON RATED LOAD	I_{FSM}	35								A
TYPICAL JUNCTION CAPACITANCE (NOTE 1)	C_J	70								PF
TYPICAL THERMAL RESISTANCE (NOTE 2)	$R_{\theta ja}$	50								$^\circ\text{C}/\text{W}$
STORAGE TEMPERATURE RANGE	T_{STG}	- 55 TO + 150								$^\circ\text{C}$
OPERATING TEMPERATURE RANGE	T_{OP}	- 55 TO + 150								$^\circ\text{C}$

ELECTRICAL CHARACTERISTICS (AT $T_A=25^\circ\text{C}$ UNLESS OTHERWISE NOTED)

CHARACTERISTICS	SYMBOL	MUR 105	MUR 110	MUR 115	MUR 120	MUR 140	MUR 160	MUR 180	MUR 1100	UNITS
MAXIMUM FORWARD VOLTAGE AT I_O DC	V_F	0.875				1.25		1.75		V
MAXIMUM REVERSE CURRENT AT 25°C	I_R	2				5				μA
MAXIMUM REVERSE CURRENT AT 100°C	I_R	50								μA
MAXIMUM REVERSE RECOVERY TIME (NOTE 3)	T_{RR}	25				50		75		nS

- NOTE:
1. MEASURED AT 1 MHZ AND APPLIED REVERSE VOLTAGE OF 4.0 VOLTS
 2. BOTH LEADS ATTACHED TO HEAT SINK 20×20×1t(mm) COPPER PLATE AT LEAD LENGTH 5mm
 3. REVERSE RECOVERY TEST CONDITIONS: $I_F=0.5\text{A}$, $I_R=1.0\text{A}$, $I_{RR}=0.25\text{A}$

RATINGS AND CHARACTERISTIC CURVE MUR105 THRU MUR1100

FIG. 1-TEST CIRCUIT DIAGRAM AND REVERSE RECOVERY TIME CHARACTERISTIC

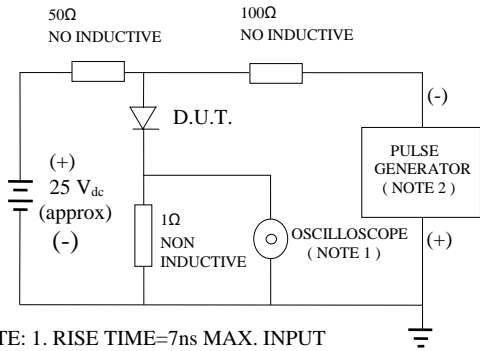

NOTE: 1. RISE TIME=7ns MAX. INPUT IMPEDANCE=1 MOhms 22PF
 2. RISE TIME =10ns MAX. SOURCE IMPEDANCE=50 OHMS

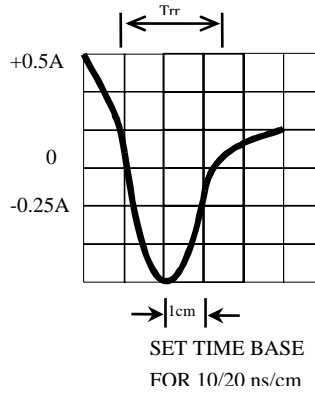

FIG. 2-TYPICAL FORWARD CURRENT DERATING CURVE

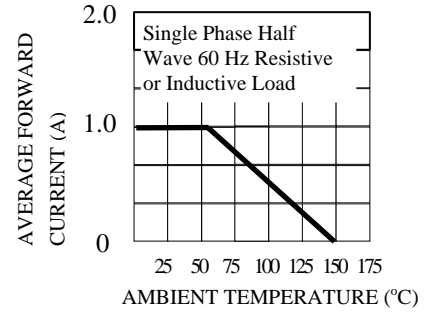

FIG. 3-TYPICAL REVERSE CHARACTERISTICS

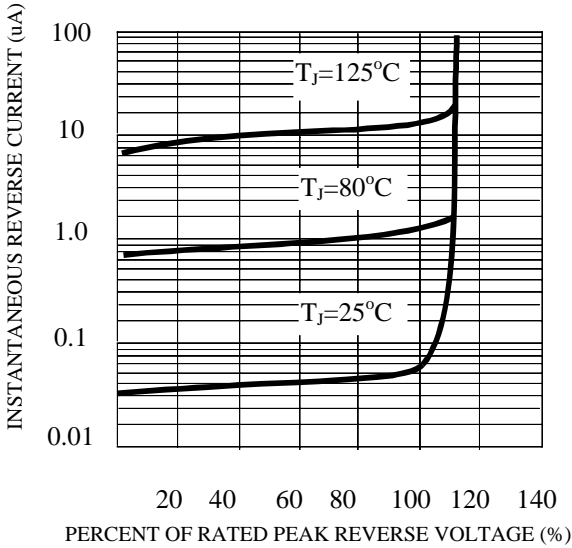

FIG. 4-TYPICAL INSTANTANEOUS FORWARD CHARACTERISTICS

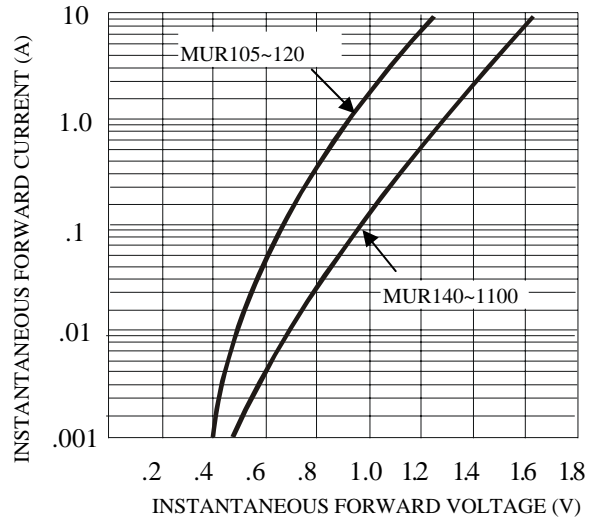

FIG. 5-MAXIMUM NON-REPETITIVE FORWARD SURGE CURRENT

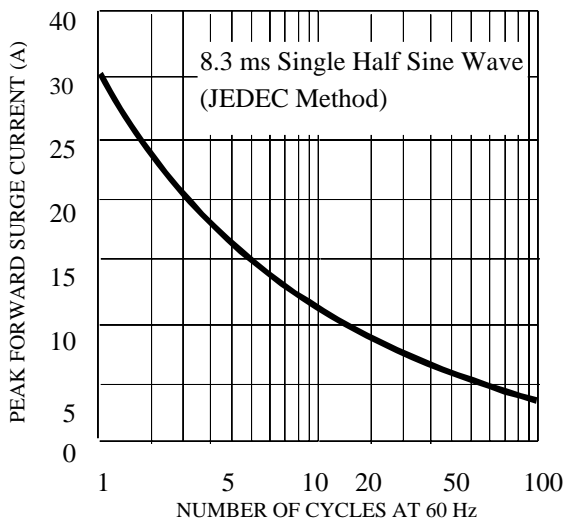

FIG. 6-TYPICAL JUNCTION CAPACITANCE

