

**VI TELEFILTER**

**Filter specification**

**TFS 895**

**1/5**

**Measurement condition**

Ambient temperature:	23	°C
Input power level:	0	dBm
Terminating impedance:		
Input:	50	Ω
Output:	50	Ω

**Characteristics**

Remark:

The maximum attenuation in the pass band is defined as the insertion loss  $a_e$ . The nominal frequency  $f_N$  is fixed at 895,5 MHz without any tolerance or limit. The values of absolute attenuation  $a_{abs}$  are guaranteed for the whole operating temperature range. The frequency shift of the filter in the operating temperature range is included in the production tolerance scheme.

D a t a		typ. value		tolerance / limit	
<b>Insertion loss</b>	$a_e$	2,2	dB	max.	2,7 dB
<b>Insertion loss at ambient temperature</b>		2,0	dB	max.	2,2 dB
<b>Nominal frequency</b>	$f_N$	-			895,5 MHz
<b>Passband</b>	PB	45	MHz	$f_N \pm$	19,5 MHz
<b>Pass band variation</b>		1,5	dB	max.	1,9 dB
<b>Pass band variation at ambient temperature</b>		1,2	dB	max.	1,5 dB
<b>Absolute attenuation</b>	$a_{abs}$				
0,3 MHz ... 856 MHz		20	dB	min.	17 dB
925 MHz ... 935 MHz		15	dB	min.	4 dB
925 MHz ... 935 MHz	at ambient temperature	35	dB	min.	6 dB
935 MHz ... 2000 MHz		23	dB	min.	20 dB
2000 MHz ... 3660 MHz		10	dB	min.	5 dB
<b>VSWR within PB</b>		2,5 : 1		max.	3,0 : 1
<b>Input power level</b>		-		max.	20 dBm
<b>Operating temperature range</b>	OTR	-			- 30 °C ... + 80°C
<b>Storage temperature range</b>		-			- 40 °C ... + 85°C
<b>Temperature coefficient of frequency</b>	$TC_f^*$	- 43	ppm/K		-

\*)  $\Delta f(\text{Hz}) = TC_f(\text{ppm/K}) \times (T - T_0) \times f_{T0}(\text{MHz})$

**Generated:**

---

**Checked / Approved:**

---

Tele Filter GmbH  
 Potsdamer Straße 18  
 D 14 513 TELTOW / Germany  
 Tel: (+49) 3328 4784-0 / Fax: (+49) 3328 4784-30  
 E-Mail: [tft@telefilter.com](mailto:tft@telefilter.com)

VI TELEFILTER reserves the right to make changes to the product(s) and/or information contained herein without notice. No liability is assumed as a result of their use or application. No rights under any patent accompany the sale of any such product(s) or information.

**Filter characteristic**

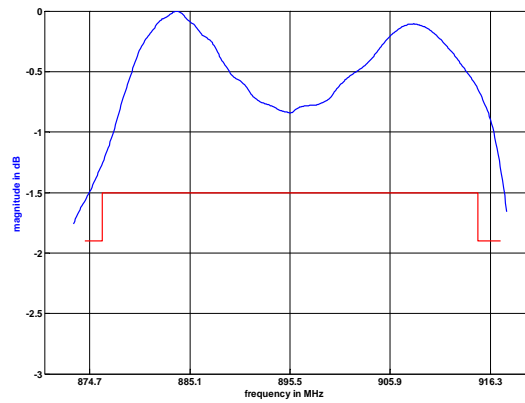
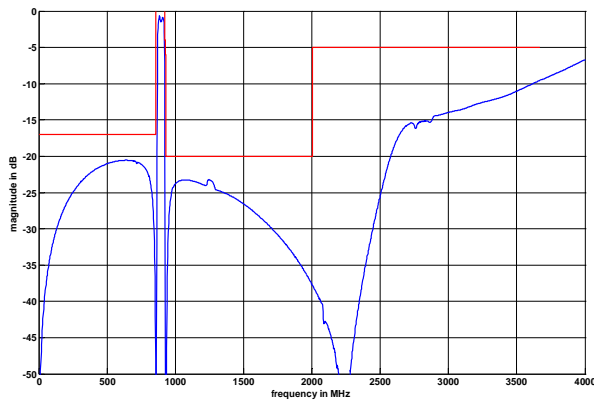

**Construction and pin connection**

(All dimensions in mm)

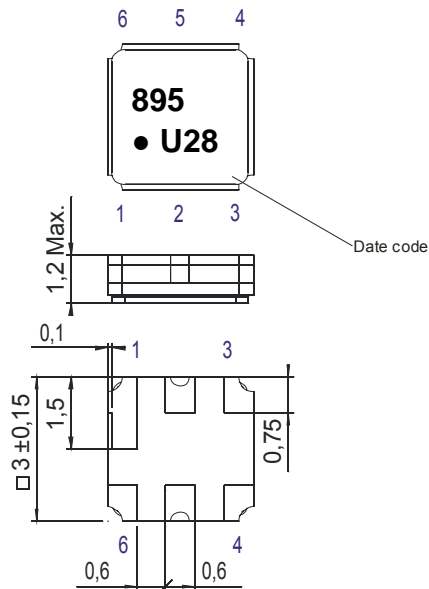

- 1 Ground
- 2 Input
- 3 Ground
- 4 Ground
- 5 Output
- 6 Ground

Date code: Year + week  
 U 2006  
 V 2007  
 W 2008  
 ...

**50 Ohm Test circuit**

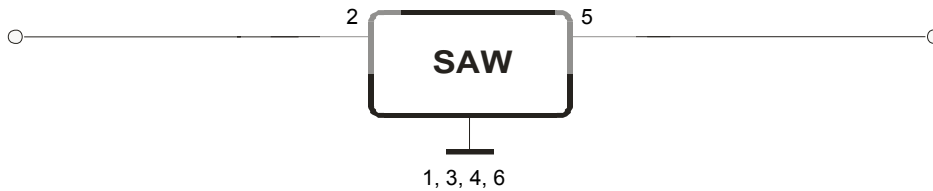

**Tele Filter GmbH**  
 Potsdamer Straße 18  
 D 14 513 TELTOW / Germany  
 Tel: (+49) 3328 4784-0 / Fax: (+49) 3328 4784-30  
 E-Mail: [tft@telefilter.com](mailto:tft@telefilter.com)

VI TELEFILTER reserves the right to make changes to the product(s) and/or information contained herein without notice. No liability is assumed as a result of their use or application. No rights under any patent accompany the sale of any such product(s) or information.

**Stability characteristics, reliability**

After the following tests the filter shall meet the whole specification:

1. Shock: 500g, 1 ms, half sine wave, 3 shocks each plane;  
DIN IEC 68 T2 - 27
2. Vibration: 10 Hz to 500 Hz, 0,35 mm or 5 g respectively, 1 octave per min, 10 cycles per plan, 3 plans;  
DIN IEC 68 T2 - 6
3. Change of temperature: -55 °C to 125°C / 30 min. each / 10 cycles  
DIN IEC 68 part 2 – 14 Test N
4. Resistance to solder heat (reflow): reflow possible: three times max.;  
for temperature conditions refer to the attached "Air reflow temperature conditions" on page 4;

This filter is RoHS compliant (2002/95/EG, 2005/618/EG)

**Packing**

Tape & Reel: IEC 286 – 3, with exception of value for N and minimum bending radius;  
tape type II, embossed carrier tape with top cover tape on the upper side;

max. pieces of filters per reel:	9000
reel of empty components at start:	min. 300 mm
reel of empty components at start including leader:	min. 500 mm
trailer:	min. 300 mm

**Tape (all dimensions in mm)**

- W : 8,00 ± 0,3
- Po : 4,00 ± 0,1
- Do : 1,50 +0,1/-0
- E : 1,75 ± 0,1
- F : 3,50 ± 0,05
- G(min) : 0,75
- P2 : 2,00 ± 0,05
- P1 : 4,00 ± 0,1
- D1(min) : 1,50
- Ao : 3,25 ± 0,1
- Bo : 3,25 ± 0,1
- Ct : 5,5 ± 0,1

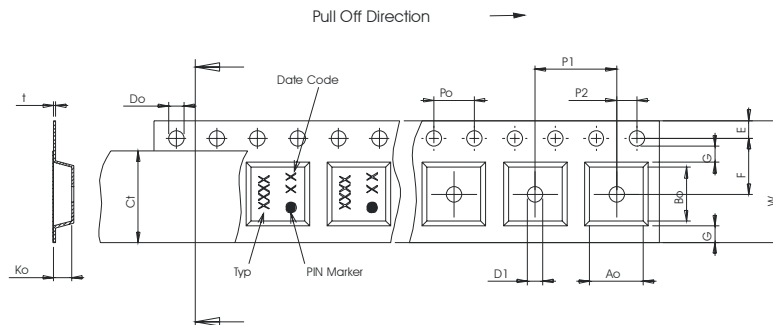

**Reel (all dimensions in mm)**

- A : 330
- W1 : 8,4 +1,5/-0
- W2(max) : 14,4
- N(min) : 50
- C : 13,0 +0,5/-0,2

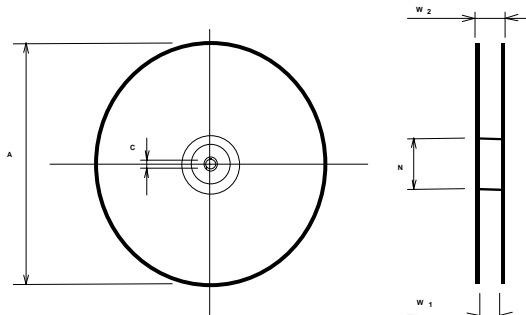

The minimum bending radius is 45 mm.

**Tele Filter GmbH**  
**Potsdamer Straße 18**  
**D 14 513 TELTOW / Germany**  
**Tel: (+49) 3328 4784-0 / Fax: (+49) 3328 4784-30**  
**E-Mail: [tft@telefilter.com](mailto:tft@telefilter.com)**

VI TELEFILTER reserves the right to make changes to the product(s) and/or information contained herein without notice. No liability is assumed as a result of their use or application. No rights under any patent accompany the sale of any such product(s) or information.

**Air reflow temperature conditions**

<b>Conditions</b>	<b>Exposure</b>
Average ramp-up rate (30°C to 217°C)	less than 3°C/second
> 100°C	between 300 and 600 seconds
> 150°C	between 240 and 500 seconds
> 217°C	between 30 and 150 seconds
Peak temperature	max. 260°C
Time within 5°C of actual peak temperature	between 10 and 30 seconds
Cool-down rate (Peak to 50°C)	less than 6°C/second
Time from 30°C to Peak temperature	no greater than 300 seconds

**Chip-mount air reflow profile**

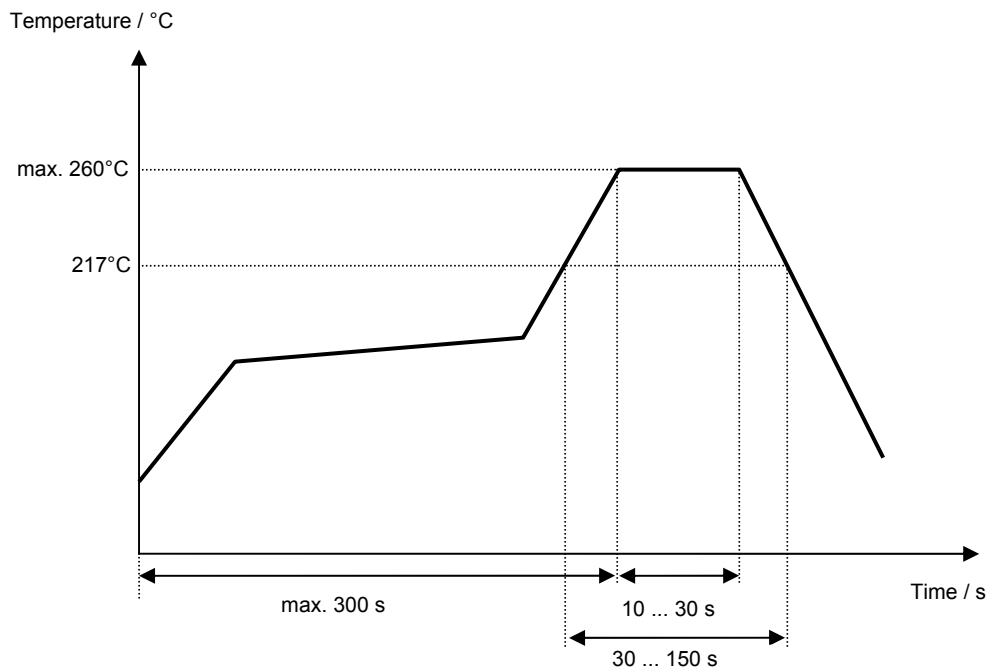

**VI TELEFILTER****Filter specification****TFS 895****5/5****History**

<b>Version</b>	<b>Reason of Changes</b>	<b>Name</b>	<b>Date</b>
1.0	Generation of development specification	Strehl	31.03.2006
1.1	Add typ. value and filter characteristic Generation of filter specification	Strehl	26.06.2006
1.2	package changed to 3x3 6 pad with long pin 1	Steiner	11.7.2006

---

**Tele Filter GmbH**  
**Potsdamer Straße 18**  
**D 14 513 TELTOW / Germany**  
**Tel: (+49) 3328 4784-0 / Fax: (+49) 3328 4784-30**  
**E-Mail: [tft@telefilter.com](mailto:tft@telefilter.com)**

VI TELEFILTER reserves the right to make changes to the product(s) and/or information contained herein without notice. No liability is assumed as a result of their use or application. No rights under any patent accompany the sale of any such product(s) or information.