

FJN13003

High Voltage Switch Mode Application

- High Speed Switching
- Suitable for Electronic Ballast up to 21W

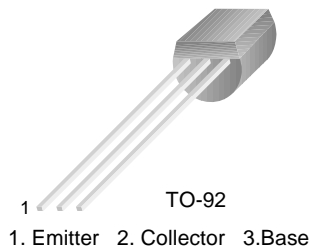

NPN Silicon Transistor Planar Silicon Transistor

Absolute Maximum Ratings $T_C=25^\circ\text{C}$ unless otherwise noted

Symbol	Parameter	Value	Units
V_{CBO}	Collector-Base Voltage	700	V
V_{CEO}	Collector-Emitter Voltage	400	V
V_{EBO}	Emitter-Base Voltage	9	V
I_C	Collector Current (DC)	1.5	A
I_{CP}	*Collector Current (Pulse)	3	A
I_B	Base Current (DC)	0.75	A
I_{BP}	*Base Current (Pulse)	1.5	A
P_C	Collector Power Dissipation($T_a=25^\circ\text{C}$)	1.1	W
T_J	Junction Temperature	150	$^\circ\text{C}$
T_{STG}	Storage Temperature	- 65 ~ 150	$^\circ\text{C}$

* Pulse Test: Pulse Width=5ms, Duty Cycle \leq 10%

Electrical Characteristics $T_a=25^\circ\text{C}$ unless otherwise noted

Symbol	Parameter	Test Condition	Min.	Typ.	Max.	Units
BV_{CBO}	Collector-Base Breakdown Voltage	$I_C=500\mu\text{A}, I_E=0$	700			V
BV_{CEO}	Collector-Emitter Breakdown Voltage	$I_C=5\text{mA}, I_B=0$	400			V
BV_{EBO}	Emitter-Base Breakdown Voltage	$I_E=500\mu\text{A}, I_C=0$	9			V
I_{EBO}	Emitter Cut-off Current	$V_{EB}=9\text{V}, I_C=0$			10	μA
h_{FE}	DC Current Gain	$V_{CE}=2\text{V}, I_C=0.5\text{A}$	9		21	
		$V_{CE}=2\text{V}, I_C=1.0\text{A}$	5			
$V_{CE}(\text{sat})$	Collector-Emitter Saturation Voltage	$I_C=0.5\text{A}, I_B=0.1\text{A}$			0.5	V
		$I_C=1.0\text{A}, I_B=0.25\text{A}$			1.0	V
		$I_C=1.5\text{A}, I_B=0.5\text{A}$			3.0	V
$V_{BE}(\text{sat})$	Base-Emitter Saturation Voltage	$I_C=0.5\text{A}, I_B=0.1\text{A}$			1.0	V
		$I_C=1.0\text{A}, I_B=0.25\text{A}$			1.2	V
f_T	Current Gain Bandwidth Product	$V_{CE}=10\text{V}, I_C=0.1\text{A}$	4			MHz
t_{ON}	Turn ON Time	$V_{CC}=125\text{V}, I_C=1\text{A}, I_{B1}=0.2\text{A}, I_{B2}=-0.2\text{A}, R_L=125\Omega$			1.1	μs
t_{STG}	Storage Time				4.0	μs
t_F	Fall Time				0.7	μs

Typical Characteristics (Continued)

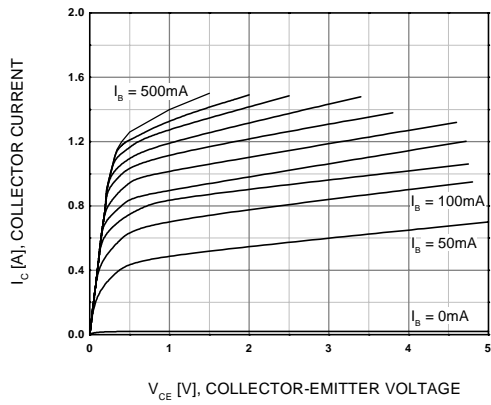

Figure 1. Static Characteristic

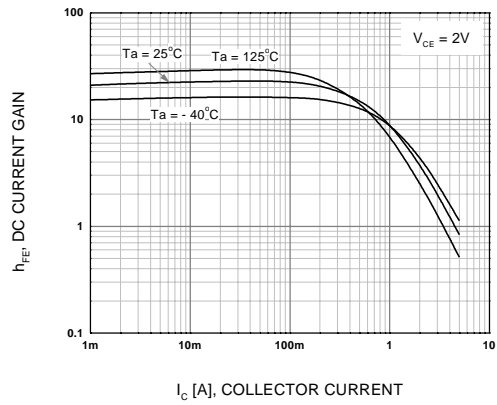

Figure 2. DC current Gain

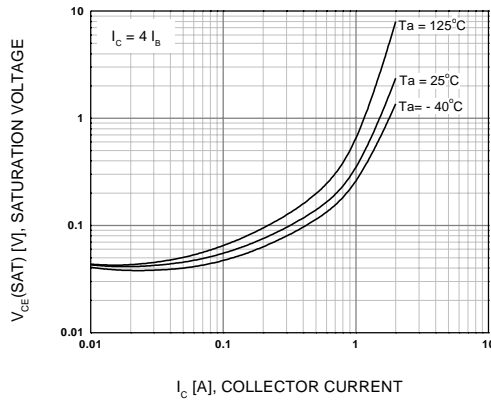

Figure 3. Collector-Emitter Saturation Voltage

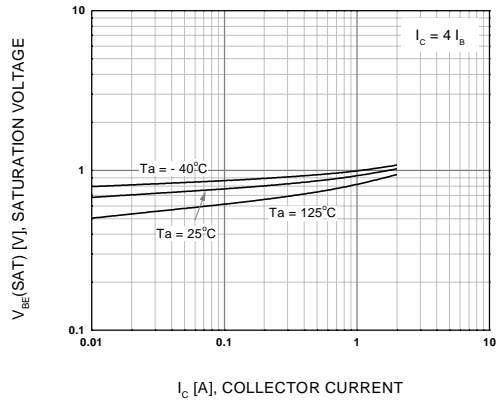

Figure 4. Base-Emitter Saturation Voltage

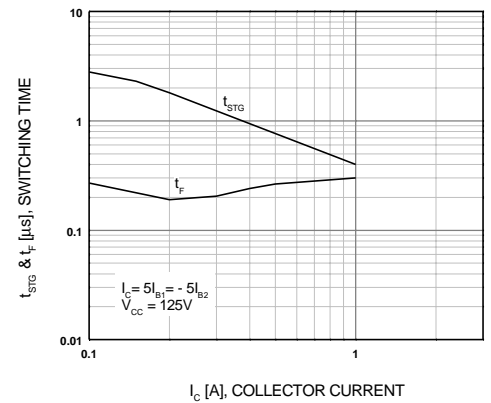

Figure 5. Resistive Load Switching Time

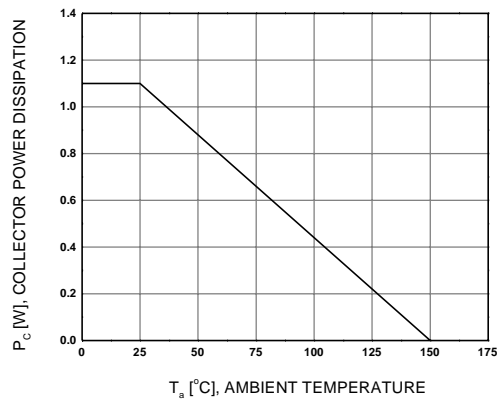

Figure 6. Power Derating

Typical Characteristics

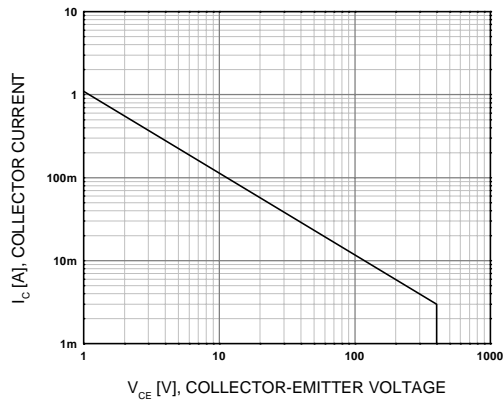

Figure 7. Forward Bias Safe Operating Area

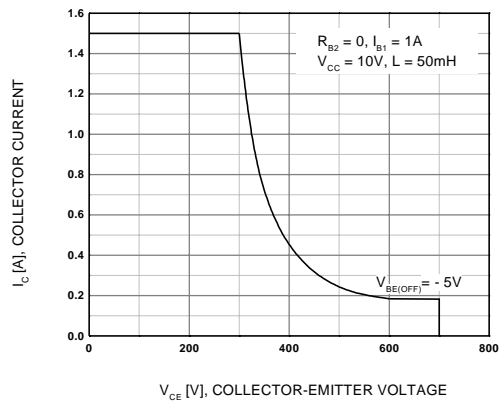
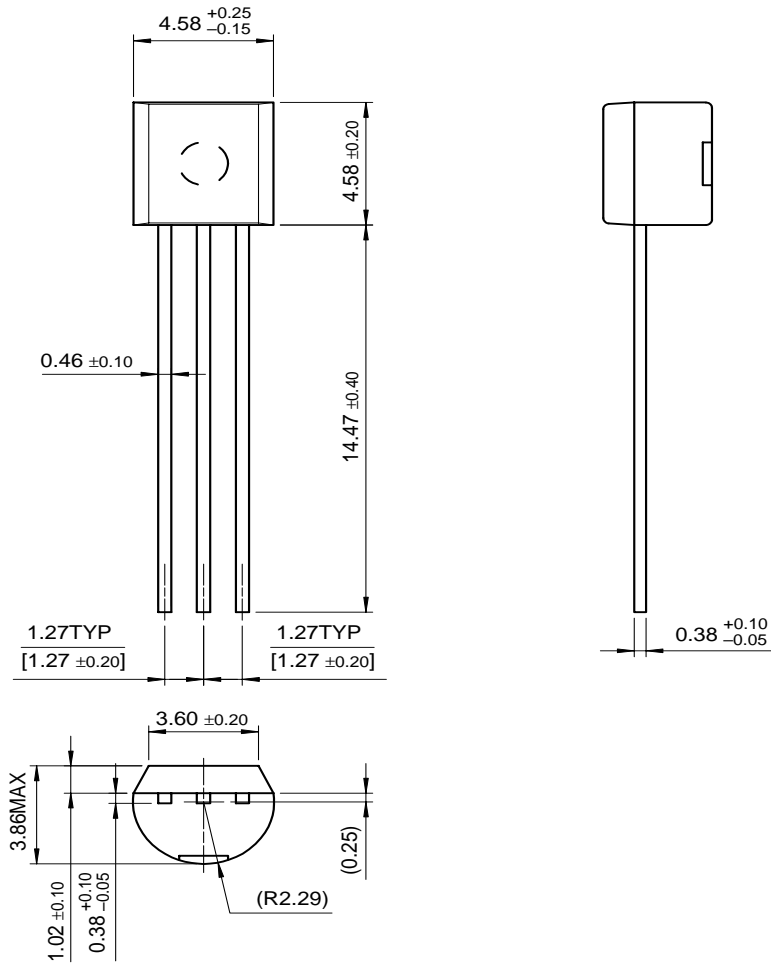

Figure 8. Reverse Bias Safe Operating Area

Package Dimensions

FJN13003

TO-92



Dimensions in Millimeters

TRADEMARKS

The following are registered and unregistered trademarks Fairchild Semiconductor owns or is authorized to use and is not intended to be an exhaustive list of all such trademarks.

ACE _x TM	FAST [®]	OPTOPLANAR TM	STAR*POWER TM
Bottomless TM	FAST _r TM	PACMAN TM	Stealth TM
CoolFET TM	FRFET TM	POP TM	SuperSOT TM -3
CROSSVOLT TM	GlobalOptoisolator TM	Power247 TM	SuperSOT TM -6
DenseTrench TM	GTO TM	PowerTrench [®]	SuperSOT TM -8
DO _M E TM	HiSeC TM	QFET TM	SyncFET TM
EcoSPARK TM	ISOPLANAR TM	QS TM	TruTranslation TM
E ² CMOS TM	LittleFET TM	QT Optoelectronics TM	TinyLogic TM
EnSigna TM	MicroFET TM	Quiet Series TM	UHC TM
FACT TM	MICROWIRE TM	SLIENT SWITCHER [®]	UltraFET [®]
FACT Quiet Series TM	OPTOLOGIC TM	SMART START TM	VCX TM

STAR*POWER is used under license

DISCLAIMER

FAIRCHILD SEMICONDUCTOR RESERVES THE RIGHT TO MAKE CHANGES WITHOUT FURTHER NOTICE TO ANY PRODUCTS HEREIN TO IMPROVE RELIABILITY, FUNCTION OR DESIGN. FAIRCHILD DOES NOT ASSUME ANY LIABILITY ARISING OUT OF THE APPLICATION OR USE OF ANY PRODUCT OR CIRCUIT DESCRIBED HEREIN; NEITHER DOES IT CONVEY ANY LICENSE UNDER ITS PATENT RIGHTS, NOR THE RIGHTS OF OTHERS.

LIFE SUPPORT POLICY

FAIRCHILD'S PRODUCTS ARE NOT AUTHORIZED FOR USE AS CRITICAL COMPONENTS IN LIFE SUPPORT DEVICES OR SYSTEMS WITHOUT THE EXPRESS WRITTEN APPROVAL OF FAIRCHILD SEMICONDUCTOR CORPORATION.

As used herein:

1. Life support devices or systems are devices or systems which, (a) are intended for surgical implant into the body, or (b) support or sustain life, or (c) whose failure to perform when properly used in accordance with instructions for use provided in the labeling, can be reasonably expected to result in significant injury to the user.
2. A critical component is any component of a life support device or system whose failure to perform can be reasonably expected to cause the failure of the life support device or system, or to affect its safety or effectiveness.

PRODUCT STATUS DEFINITIONS

Definition of Terms

Datasheet Identification	Product Status	Definition
Advance Information	Formative or In Design	This datasheet contains the design specifications for product development. Specifications may change in any manner without notice.
Preliminary	First Production	This datasheet contains preliminary data, and supplementary data will be published at a later date. Fairchild Semiconductor reserves the right to make changes at any time without notice in order to improve design.
No Identification Needed	Full Production	This datasheet contains final specifications. Fairchild Semiconductor reserves the right to make changes at any time without notice in order to improve design.
Obsolete	Not In Production	This datasheet contains specifications on a product that has been discontinued by Fairchild semiconductor. The datasheet is printed for reference information only.

find products

Home >> Find products >>

Products groups

Analog and Mixed

Signal

Discrete

Interface

Logic

Microcontrollers

Non-Volatile

Memory

Optoelectronics

Markets and applications

New products

Product selection and parametric search

Cross-reference search

FJN13003
NPN Silicon Transistor

Contents

Features | [Product status/pricing/packaging](#) |

[Models](#)

Features

High Voltage Switch Mode Application

- High Speed Switching
- Suitable for Electronic Ballast up to 21W

[back to top](#)

Product status/pricing/packaging

Product	Product status	Package type	Leads	Packing method
FJN13003BU	Full Production	TO-92	3	BULK
FJN13003TA	Full Production	TO-92	3	TAPE REEL

[back to top](#)

Models

Package & leads	Condition	Temperature range	Software version	Revision date
PSPICE				
TO-92-3	Electrical	-25°C to 125°C	9.2	Dec 17, 2001

[back to top](#)

Related Links

[Request samples](#)

[Dotted line](#)

[How to order products](#)

[Dotted line](#)

[Product Change Notices](#)

[\(PCNs\)](#)

[Dotted line](#)

[Support](#)

[Dotted line](#)

[Distributor and field sales representatives](#)

[Dotted line](#)

[Quality and reliability](#)

[Dotted line](#)

[Design tools](#)

Datasheet

[Download this](#)

[datasheet](#)

PDF

[e-mail this datasheet](#)

[E-]

This page [Print version](#)

technical information

buy products

technical support

my Fairchild

company

