

Features

- 40V/50A,
 $R_{DS(ON)} = 13m$ (tpy.)@ $V_{GS} = 10V$
 $R_{DS(ON)} = 18m$ (tpy.)@ $V_{GS} = 4.5V$
- Super High Dense Cell Design
- Reliable and Rugged
- Fast Switching and Fully Avalanche Rated
- Lead Free and Green Devices Available (RoHS Compliant)

Applications

- Low Voltage Inverter Applications

Pin Description

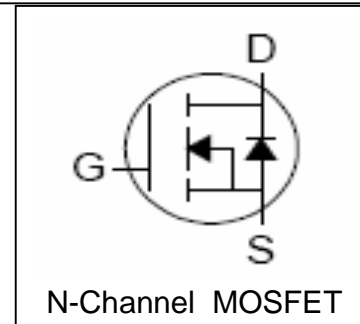
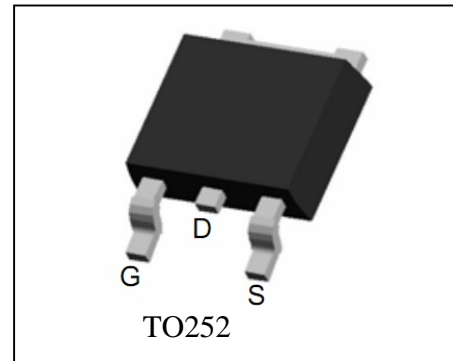

Absolute Maximum Ratings

Symbol	Parameter	Rating	Unit
Common Ratings ($T_A = 25^\circ C$ Unless Otherwise Noted)			
V_{DSS}	Drain-Source Voltage	40	V
V_{GSS}	Gate-Source Voltage	± 20	
T_J	Maximum Junction Temperature	175	$^\circ C$
T_{STG}	Storage Temperature Range	-55 to 175	$^\circ C$
I_S	Diode Continuous Forward Current	$T_C = 25^\circ C$ 50	A
Mounted on Large Heat Sink			
I_{DP}	300 μs Pulse Drain Current Tested	$T_C = 25^\circ C$ 200 ^①	A
I_D	Continuous Drain Current	$T_C = 25^\circ C$ 50 ^②	A
		$T_C = 100^\circ C$ 40	
P_D	Maximum Power Dissipation	$T_C = 25^\circ C$ 50	W
		$T_C = 100^\circ C$ 25	
$R_{\theta JC}$	Thermal Resistance-Junction to Case	3	$^\circ C/W$
Drain-Source Avalanche Ratings			
E_{AS} ^③	Avalanche Energy, Single Pulsed	100	mJ

Electrical Characteristics ($T_A=25^\circ\text{C}$ Unless Otherwise Noted)

Symbol	Parameter	Test Condition	RU3560L			Unit
			Min.	Typ.	Max.	
Static Characteristics						
BV_{DSS}	Drain-Source Breakdown Voltage	$V_{GS}=0V, I_{DS}=250\mu A$	40			V
I_{DSS}	Zero Gate Voltage Drain Current	$V_{DS}=40V, V_{GS}=0V$ $T_J=85^\circ\text{C}$			1	μA
$V_{GS(th)}$	Gate Threshold Voltage	$V_{DS}=V_{GS}, I_{DS}=250\mu A$	1.5	2	2.7	V
I_{GSS}	Gate Leakage Current	$V_{GS}=\pm 20V, V_{DS}=0V$			± 100	nA
$R_{DS(ON)}^{(4)}$	Drain-Source On-state Resistance	$V_{GS}=10V, I_{DS}=25A$		13	16	$m\Omega$
		$V_{GS}=4.5V, I_{DS}=20A$		18	22	$m\Omega$
Diode Characteristics						
$V_{SD}^{(4)}$	Diode Forward Voltage	$I_{SD}=25A, V_{GS}=0V$			1.2	V
t_{rr}	Reverse Recovery Time	$I_{SD}=25A, di_{SD}/dt=100A/\mu s$		14		ns
Q_{rr}	Reverse Recovery Charge			32		nC
Dynamic Characteristics ⁽⁵⁾						
R_G	Gate Resistance	$V_{GS}=0V, V_{DS}=0V, F=1\text{MHz}$		1.2		Ω
C_{iss}	Input Capacitance	$V_{GS}=0V,$ $V_{DS}=20V,$ Frequency=1.0MHz		980		pF
C_{oss}	Output Capacitance			160		
C_{rss}	Reverse Transfer Capacitance			80		
$t_{d(ON)}$	Turn-on Delay Time	$V_{DD}=20V, R_L=15\Omega,$ $I_{DS}=25A, V_{GEN}=10V,$ $R_G=6\Omega$		6		ns
t_r	Turn-on Rise Time			10		
$t_{d(OFF)}$	Turn-off Delay Time			24		
t_f	Turn-off Fall Time			5		
Gate Charge Characteristics ⁽⁵⁾						
Q_g	Total Gate Charge	$V_{DS}=20V, V_{GS}=10V,$ $I_{DS}=25A$		18	23	nC
Q_{gs}	Gate-Source Charge			2.5		
Q_{gd}	Gate-Drain Charge			5		

- Notes: ① Pulse width limited by safe operating area.
 ② Calculated continuous current based on maximum allowable junction temperature. Current limited by bond wire.
 ③ Limited by $T_{Jmax}, I_{AS}=20A, V_{DD}=30V, R_G=50\Omega$, Starting $T_J=25^\circ\text{C}$.
 ④ Pulse test; Pulse width $\leq 300\mu s$, duty cycle $\leq 2\%$.
 ⑤ Guaranteed by design, not subject to production testing.

Typical Characteristics

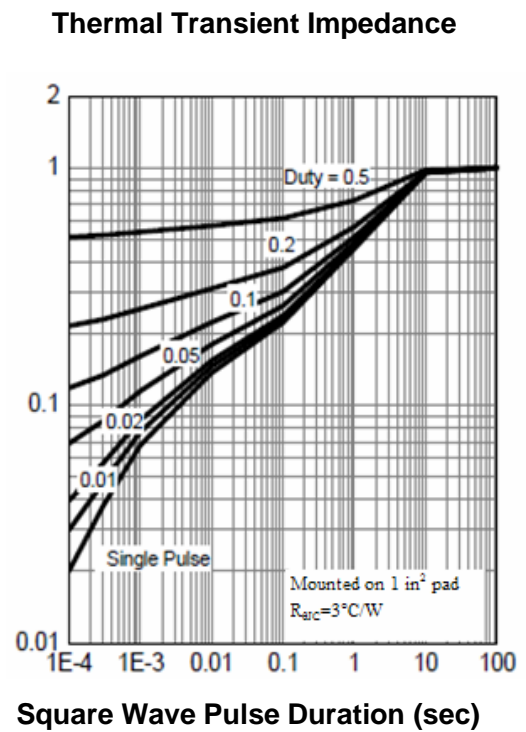
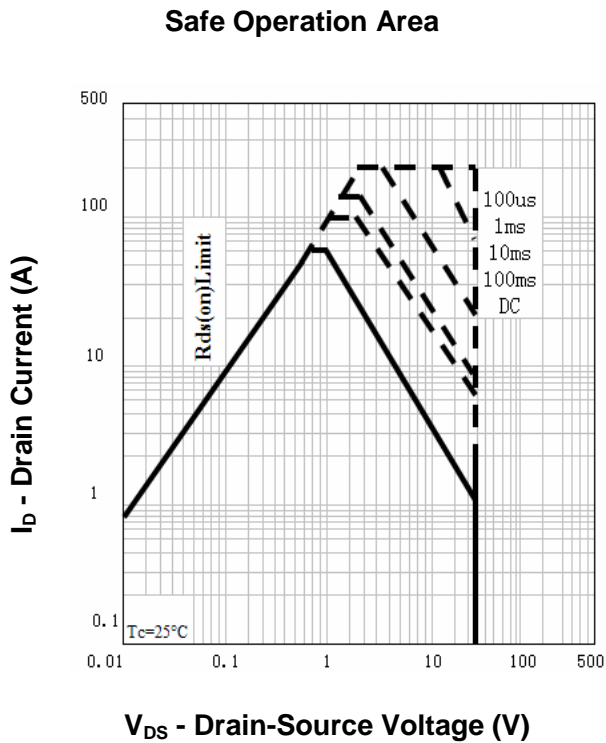
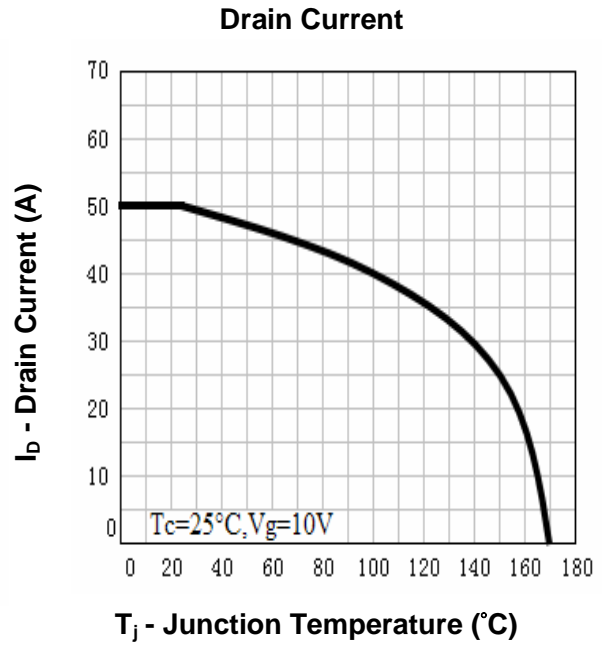
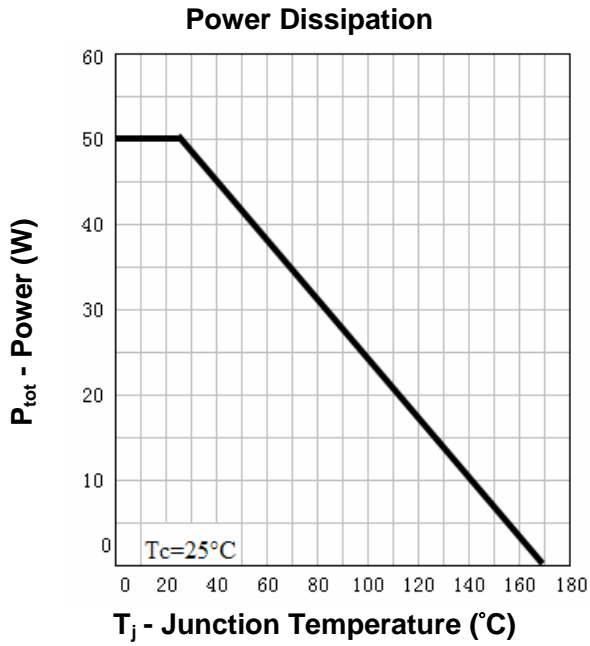

Typical Characteristics

Output Characteristics

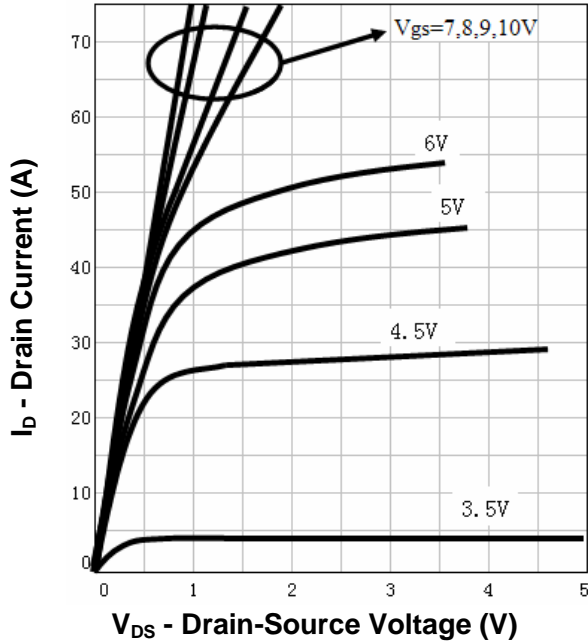

Drain-Source On Resistance

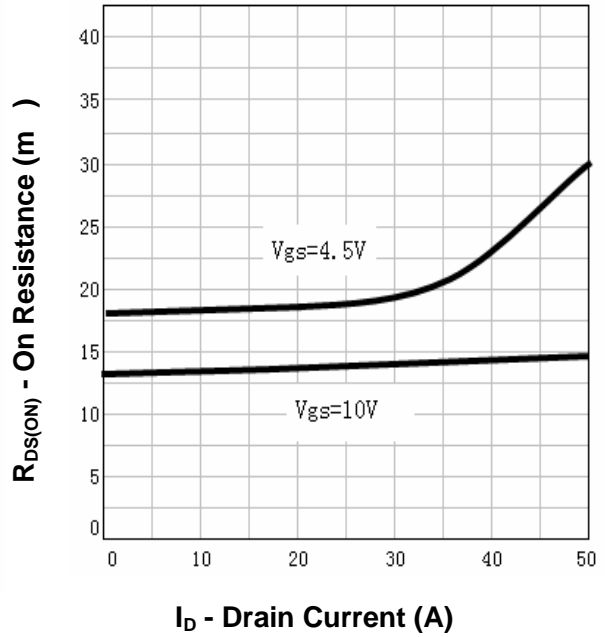

Drain-Source On Resistance

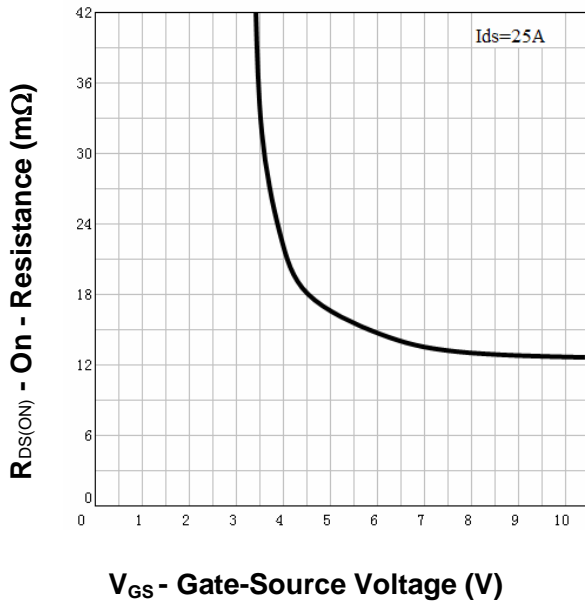

Gate Threshold Voltage

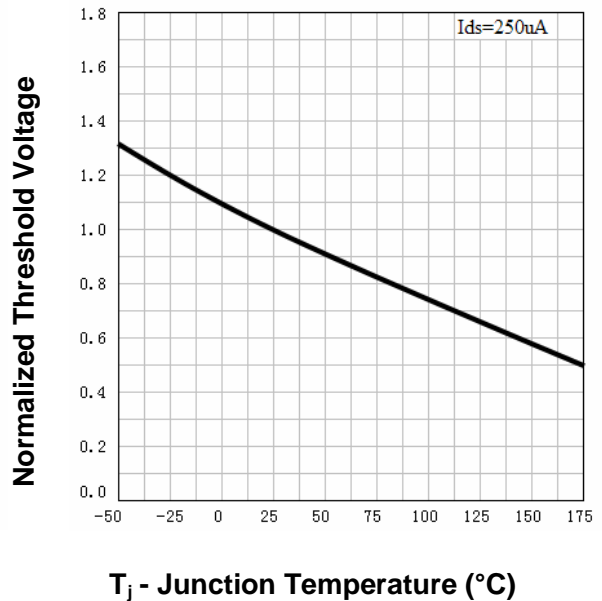

Typical Characteristics

Drain-Source On Resistance

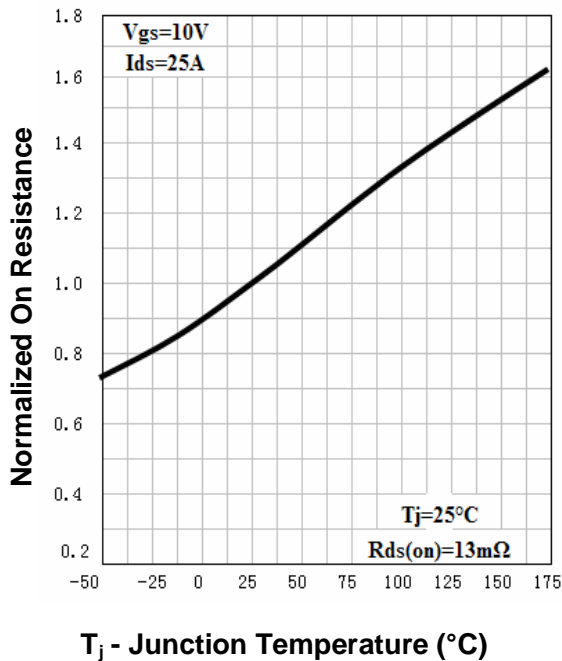

Source-Drain Diode Forward

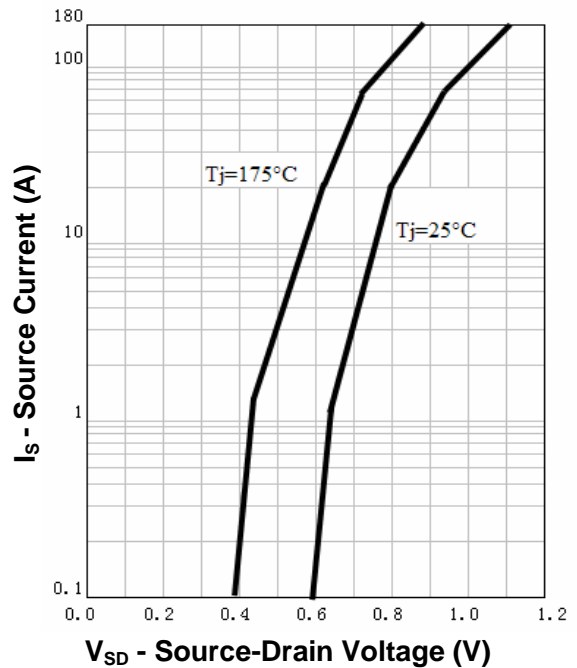

Capacitance

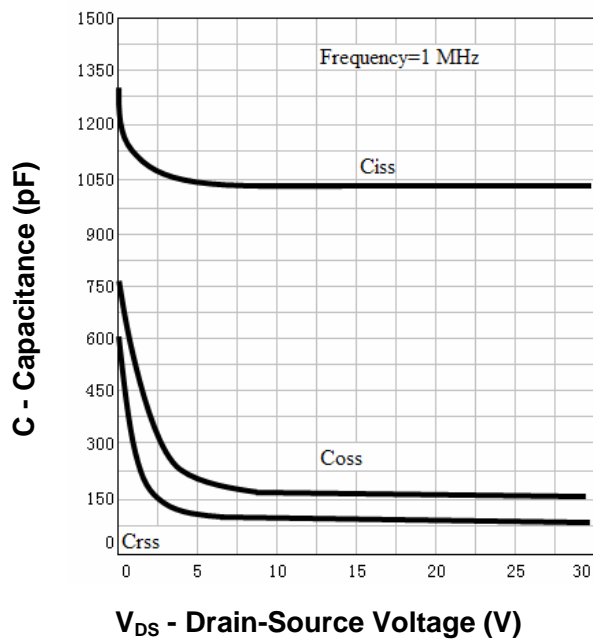

Gate Charge

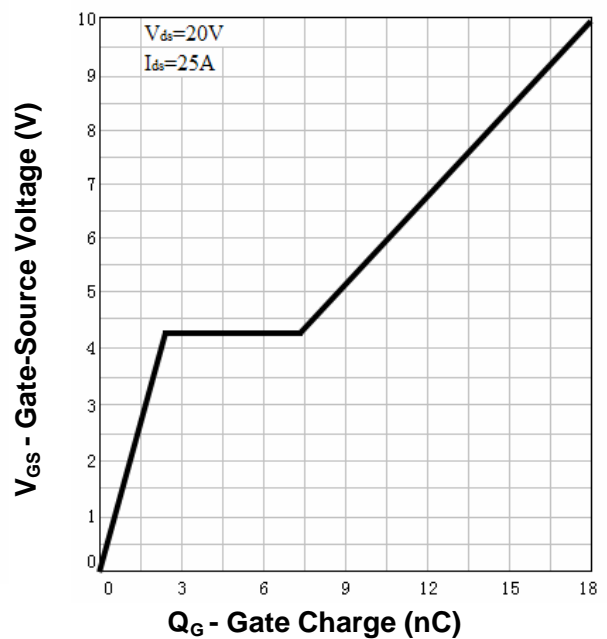

Avalanche Test Circuit and Waveforms

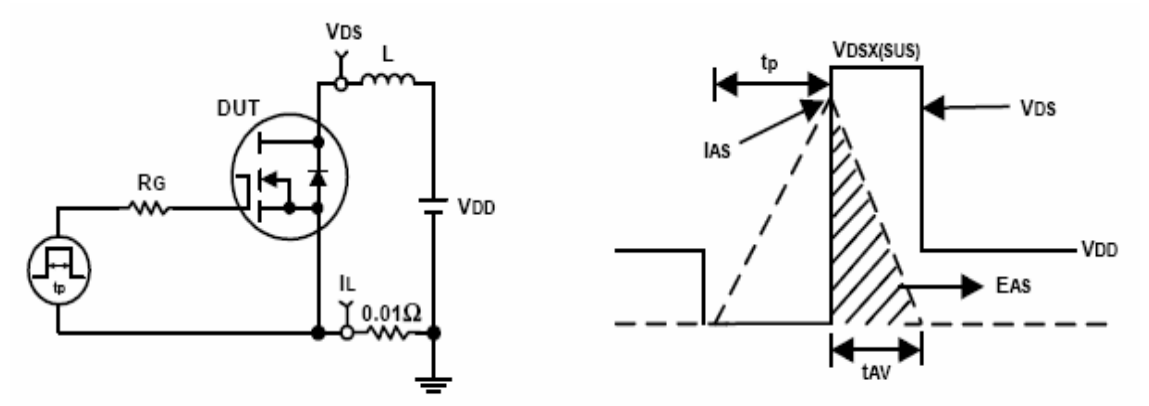

Switching Time Test Circuit and Waveforms

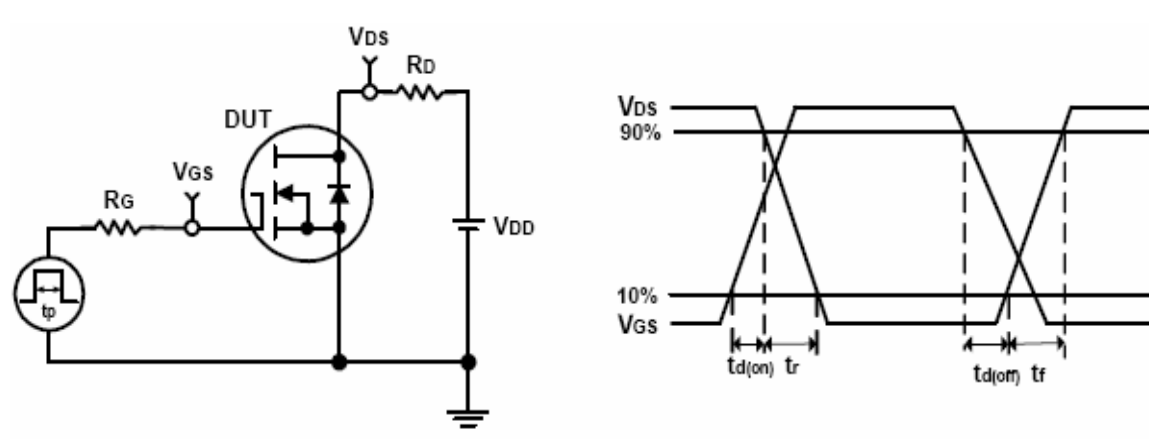

Ordering and Marking Information**RU3560****Package (Available)**

L : TO252

Operating Temperature Range

C : -55 to 150 °C

Assembly Material

G : Green & Lead Free

Packaging

T : TUBE

TR : Tape & Reel

Package Information

TO252-2L

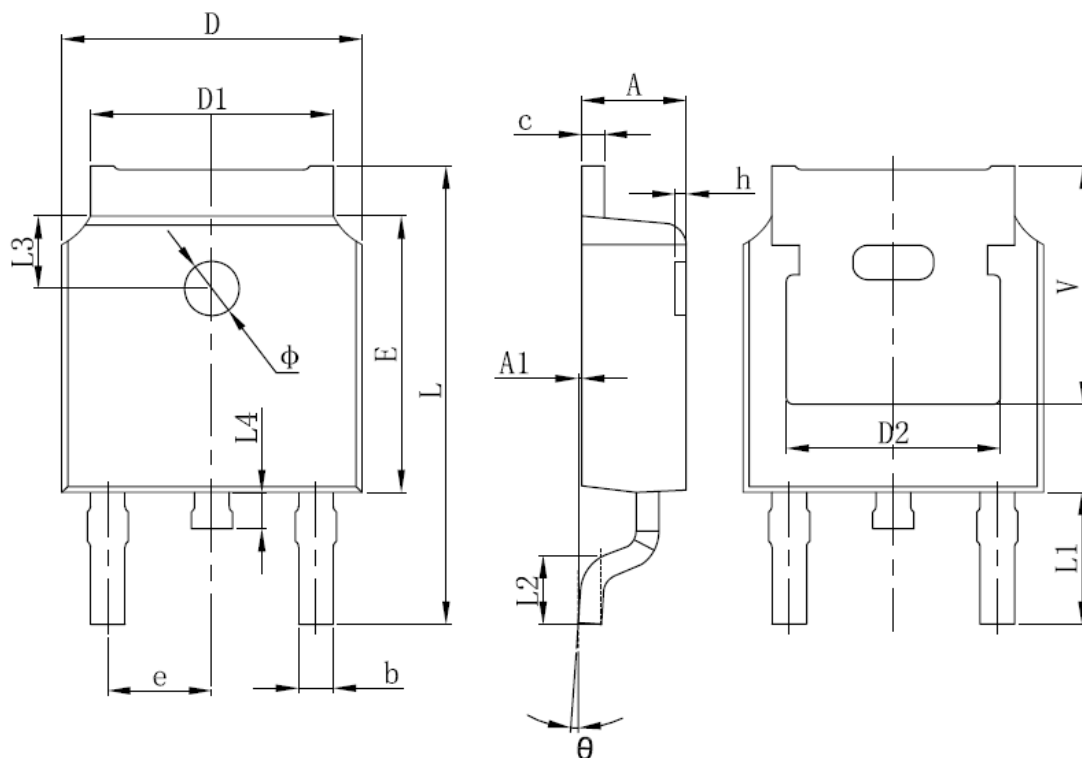

SYMBOL	MM		INCH		SYMBOL	MM		INCH	
	MIN	MAX	MIN	MAX		MIN	MAX	MIN	MAX
A	2.200	2.400	0.087	0.094	L	9.800	10.400	0.386	0.409
A1	0.000	0.127	0.000	0.005	L1	2.900 REF.		0.114 REF.	
b	0.660	0.860	0.026	0.034	L2	1.400	1.700	0.055	0.067
C	0.460	0.580	0.018	0.023	L3	1.600 REF.		0.063 REF.	
D	6.500	6.700	0.256	0.264	L4	0.600	1.000	0.024	0.039
D1	5.100	5.460	0.201	0.215	Φ	1.100	1.300	0.043	0.051
D2	4.830 REF.		0.190 REF.		θ	0°	8°	0°	8°
E	6.000	6.200	0.236	0.244	h	0.000	0.300	0.000	0.012
e	2.186	2.386	0.086	0.094	V	5.350 REF.		0.211 REF.	

ALL DIMENSIONS REFER TO JEDEC STANDARD
DO NOT INCLUDE MOLD FLASH OR PROTRUSIONS

Customer Service

Worldwide Sales and Service:

Sales@ruichips.com

Technical Support:

Technical@ruichips.com

Investor Relations Contacts:

Investor@ruichips.com

Marcom Contact:

Marcom@ruichips.com

Editorial Contact:

Editorial@ruichips.com

HR Contact:

HR@ruichips.com

Legal Contact:

Legal@ruichips.com

Shen Zhen RUICHIPS Semiconductor CO., LTD

Room 501, the 5floor An Tong Industrial Building,
NO.207 Mei Hua Road Fu Tian Area Shen Zhen City, CHINA

TEL: (86-755) 8311-5334

FAX: (86-755) 8311-4278

E-mail: Sales-SZ@ruichips.com