

LED Surface Mount Device

Unit in mm

Features

- 2 mm Thrust Out Domed Lens
- 3.2(L) x 2.4(W) x 2.5(H) mm Size
 - High Efficiency SMD Lamps
 - Realizing over 5 times Luminous than TL*1002 Series
 - Small Package - High Density Mounting is Available
- Low Drive Current
 - High Intensity Light Emission
 - Recommended Forward Current: $I_F = 10$ mA (DC)
- All Transparent Plastic Molded Lens
 - Provides Clear Indication
- Available in an Extensive Lineup from Red Light LED to Pure Green Light LED
- Fast Response Time
 - High Intensity of Pulse Operation
- Reflow Soldering is Applicable
- Packed Quantity: 1000 pcs/reel
- Applications:
 - Portable Instrument
 - Message Signboard
 - High Intensity Backlight
 - Battery-Driven Equipment

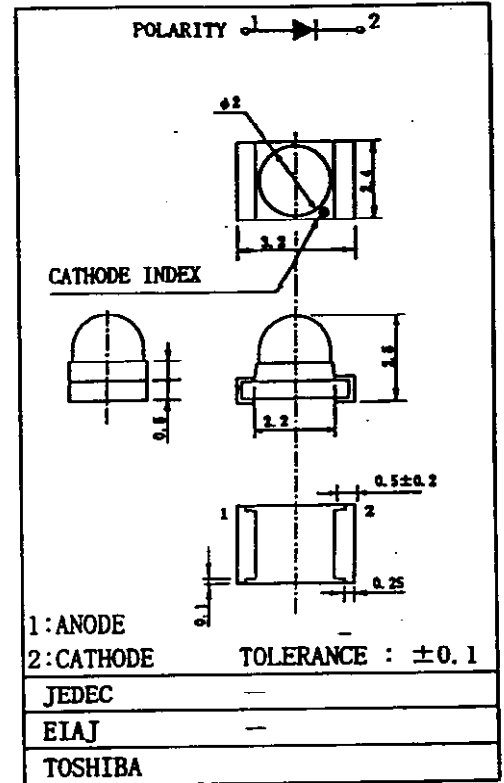

Line-Up

Product Name	Color	Material
TLPG1005	Pure Green	GaP
TLG1005	Green	GaP
TLGD1005	Green	GaP
TLYE1005	Yellow	InGaAIP
TLOE1005	Orange	InGaAIP
TLS1005	Red	GaAsP
TLRA1005	Red	GaAlAs

The information contained here is subject to change without notice.

The information contained herein is presented only as guide for the applications of our products. No responsibility is assumed by TOSHIBA for any infringements of patents or other rights of the third parties which may result from its use. No license is granted by implication or otherwise under any patent or patent rights of TOSHIBA or others. These TOSHIBA products are intended for usage in general electronic equipments (office equipment, communication equipment, measuring equipment, domestic electrification, etc.) Please make sure that you consult with us before you use these TOSHIBA products in equipments which require high quality and/or reliability, and in equipments which could have major impact to the welfare of human life (atomic energy control, spaceship, traffic signal, combustion control, all types of safety devices, etc.). TOSHIBA cannot accept liability to any damage which may occur in case these TOSHIBA products were used in the mentioned equipments without prior consultation with TOSHIBA.

**TLG1005, TLGD1005, TLPG1005,
TLOE1005, TLYE1005, TLS1005, TLRA1005**

Maximum Ratings (T_a = 25°C)

Product Name	Forward Current (DC) I _F (mA)	Reverse Voltage V _G (V)	Power Dissipation P _D (mW)	Operating Temperature T _{opr} (°C)	Storage Temperature T _{stg} (°C)
TLPG1005	25	4	65.0	-25 ~ 80	-30 ~ 85
TLG1005	25	4	62.5		
TLGD1005	25	4	62.5		
TLYE1005	25	4	62.5		
TLOE1005	25	4	60.0		
TLS1005	25	4	65.0		
TLRA1005	25	4	60.0		

Electro-Optical Characteristics (T_a = 25°C)

Product Name	Emission Spectrum			Luminous Intensity			Forward Voltage			Reverse Current	
	λ _p	Δλ		I _v			V _F			I _g	
	Typ.	Typ.	I _F	Min.	Typ.	I _F	Typ.	Max.	I _F	Max.	V _g
TLPG1005	555	20	20	4.76	12	20	2.05	2.6	20	5	4
TLG1005	567	25	20	15.3	45	20	2.05	2.5	20	5	4
TLGD1005	570	25	20	27.2	75	20	2.1	2.5	20	5	4
TLYE1005	590	13	20	85	300	20	2.1	2.5	20	50	4
TLOE1005	612	15	20	153	400	20	2.0	2.4	20	50	4
TLS1005	635	40	20	8.5	25	20	2.05	2.6	20	50	4
TLRA1005	660	25	20	153	450	20	1.85	2.4	20	50	4
UNIT	nm		mA	mcd		mA	V		mA	μA	V

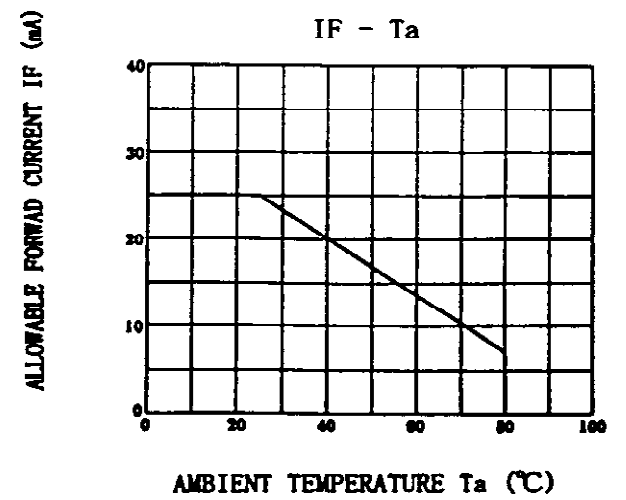
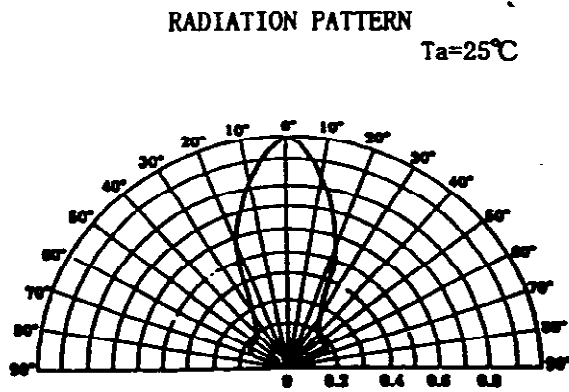
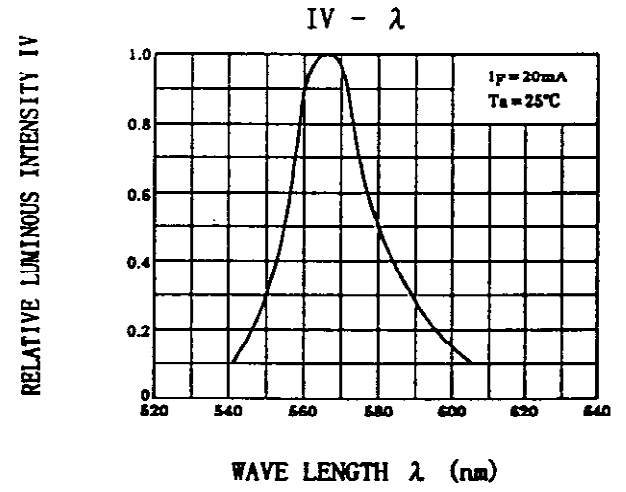
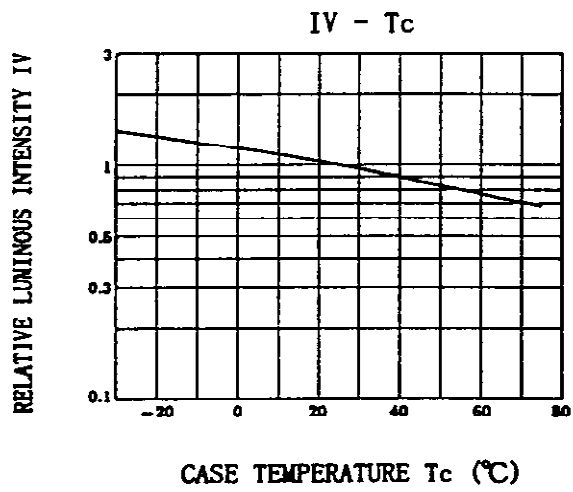
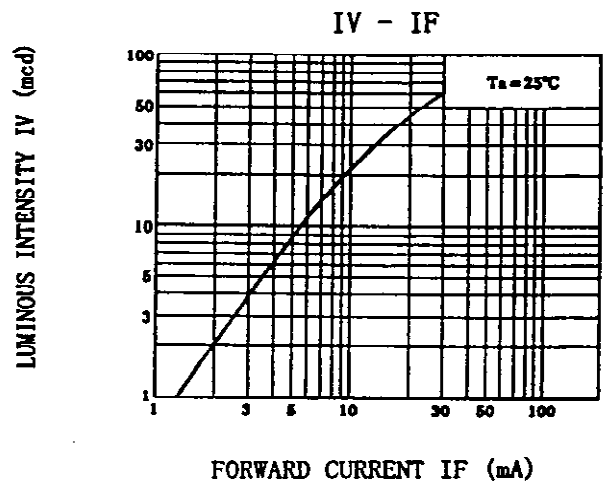
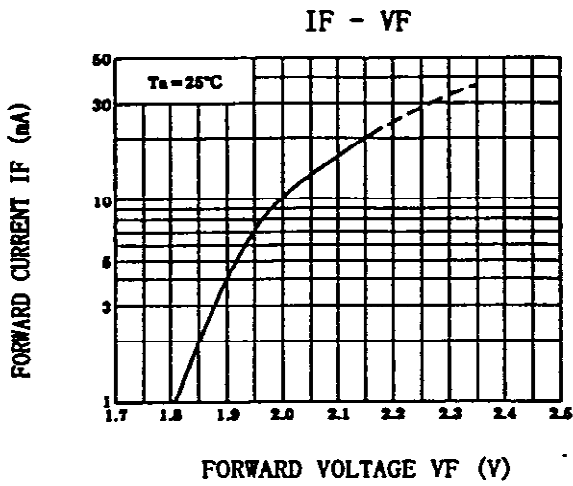

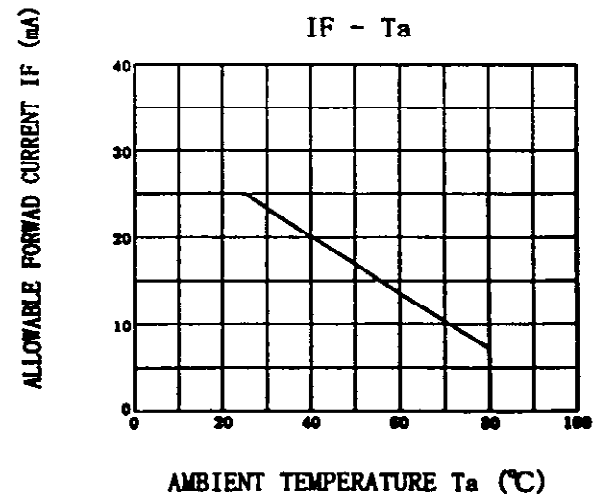
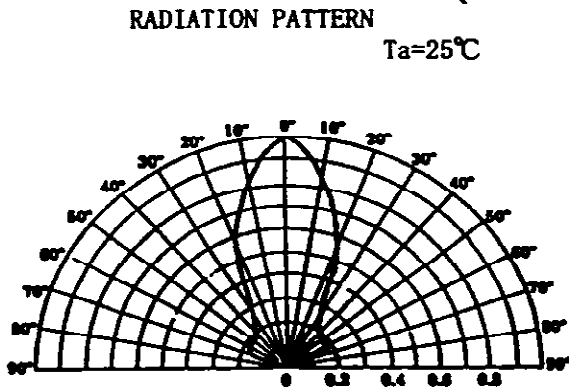
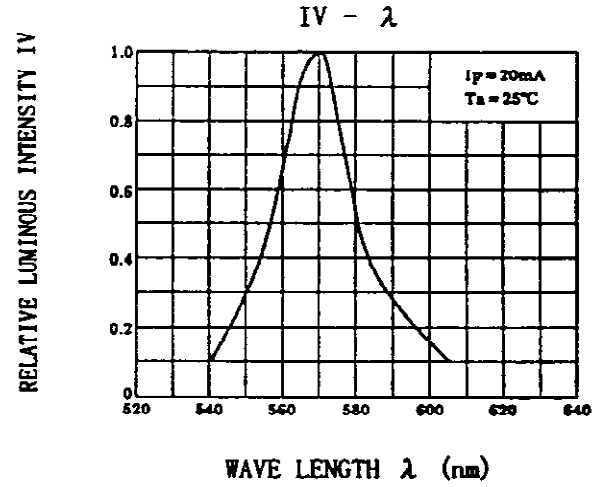
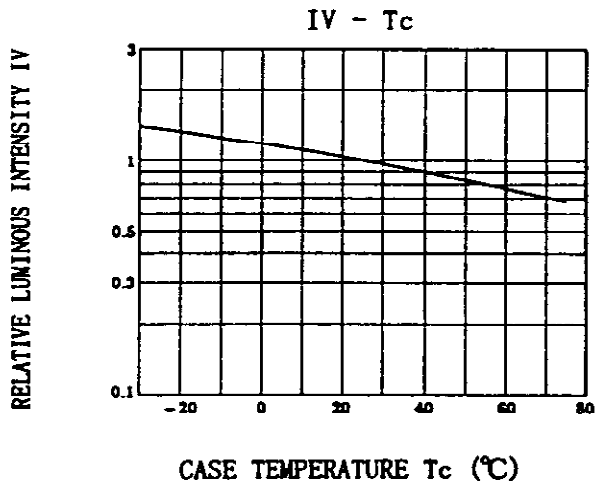
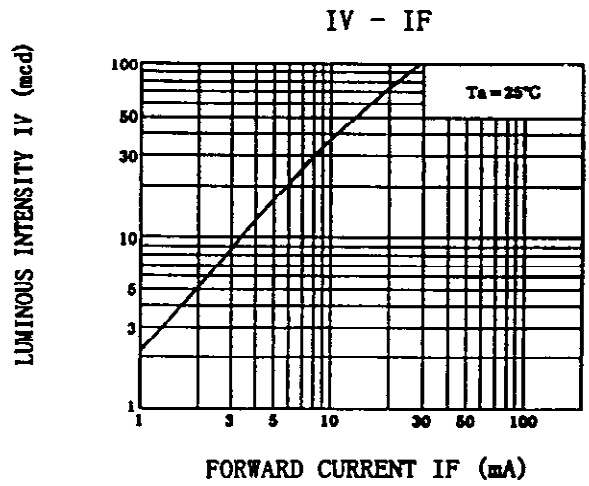
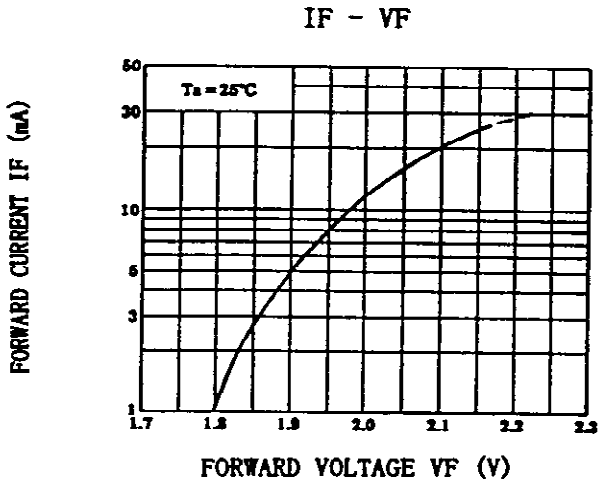

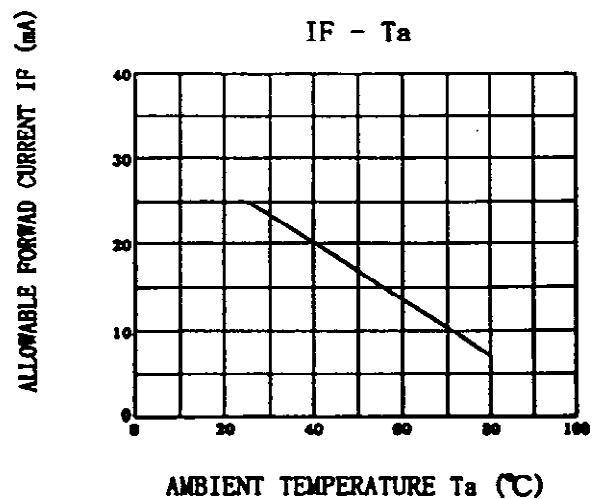
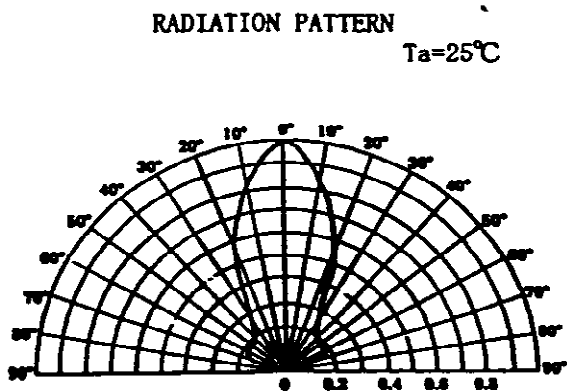
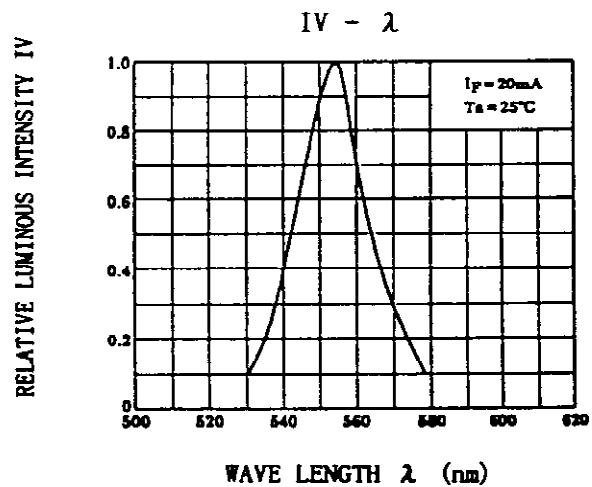
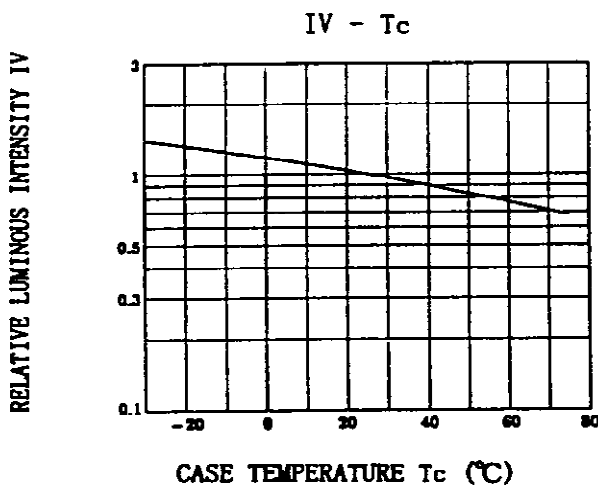
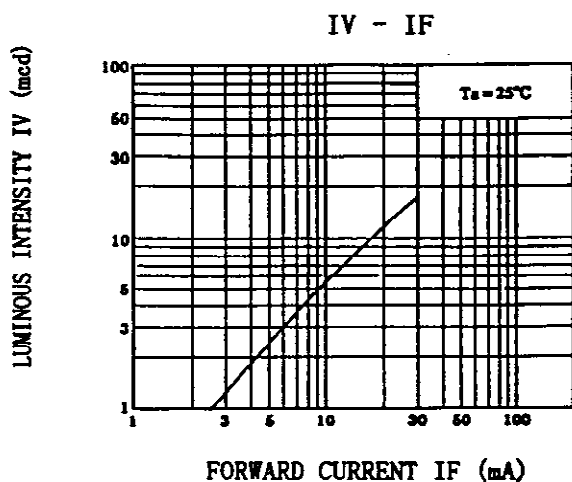
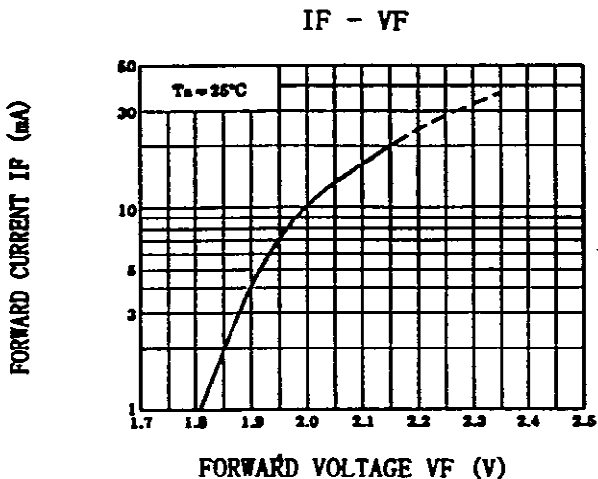

IF - VF

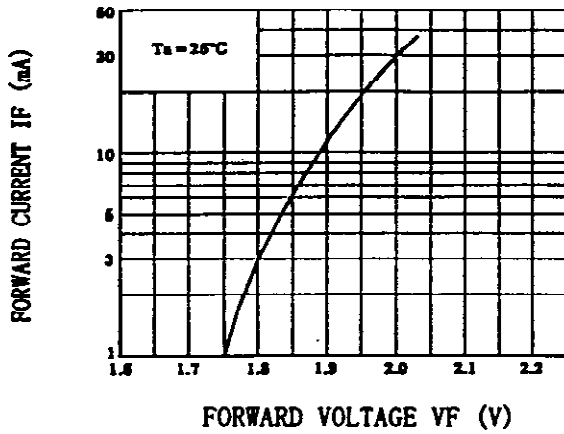

IV - IF

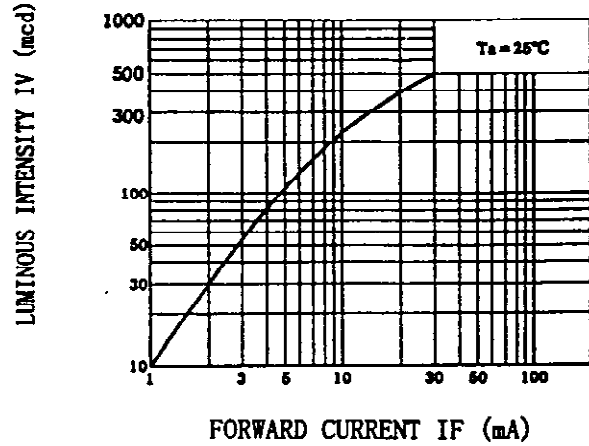

IV - Tc

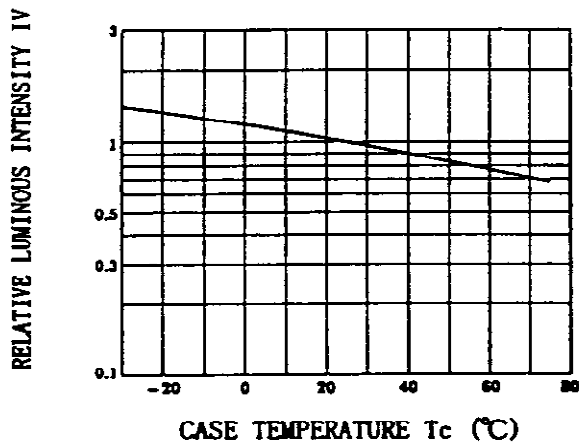

IV - λ

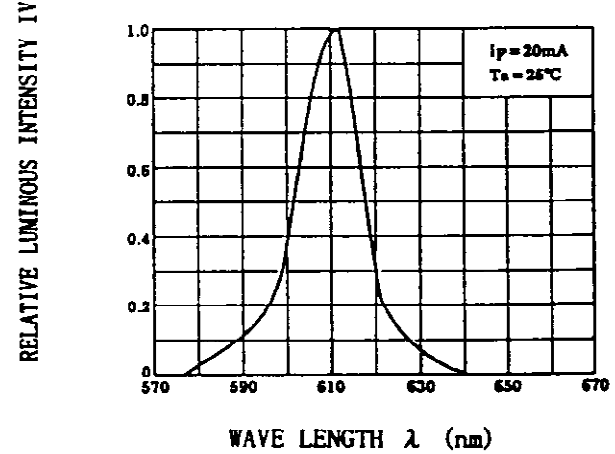

RADIATION PATTERN

$T_a = 25^\circ\text{C}$

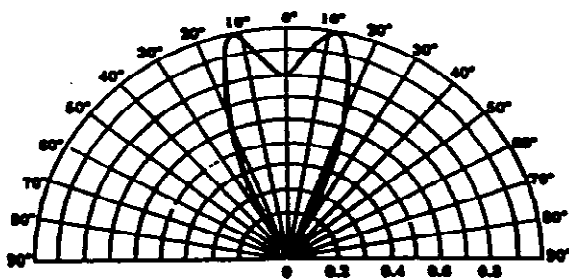

ALLOWABLE FORWARD CURRENT I_F (mA)

IF - Ta

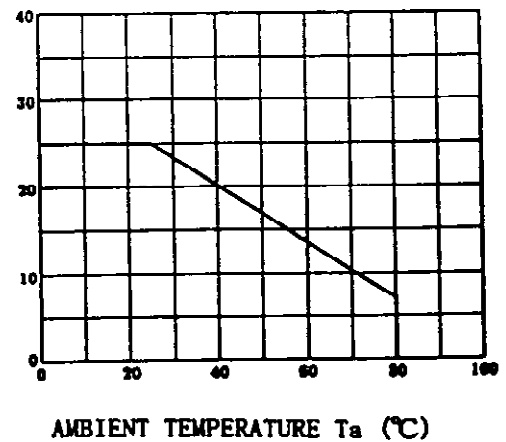

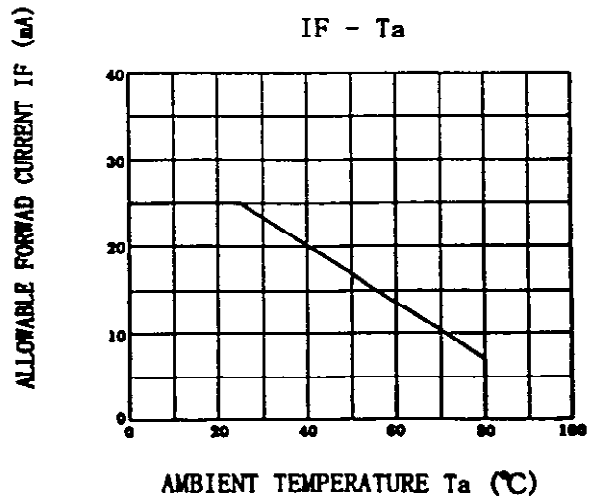
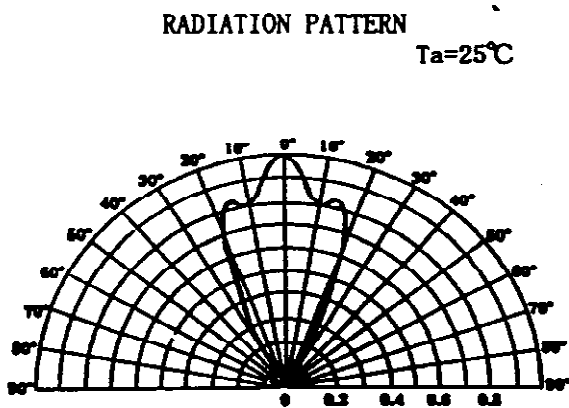
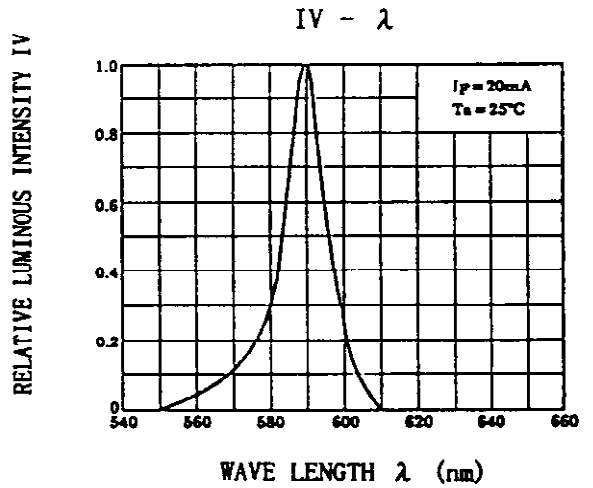
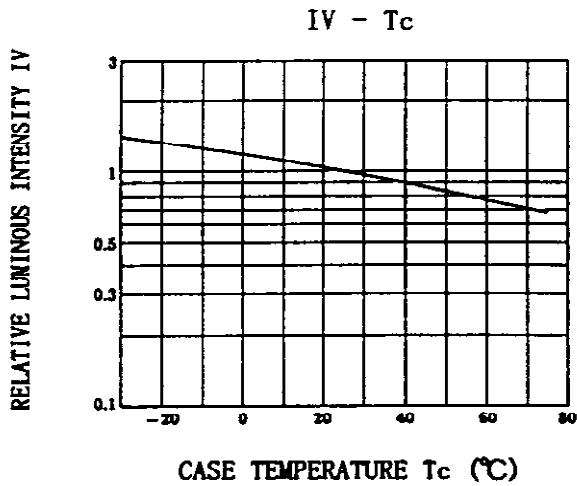
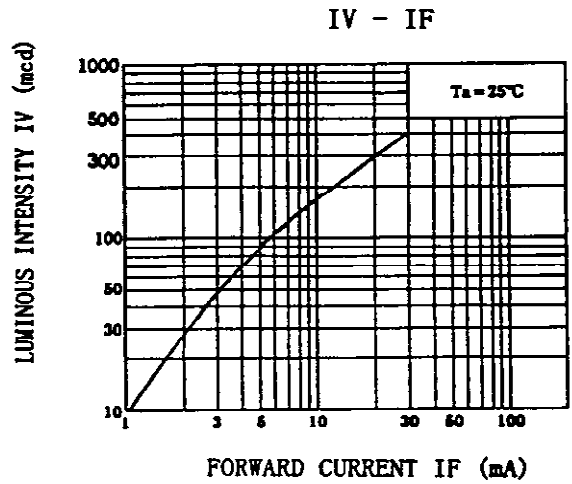
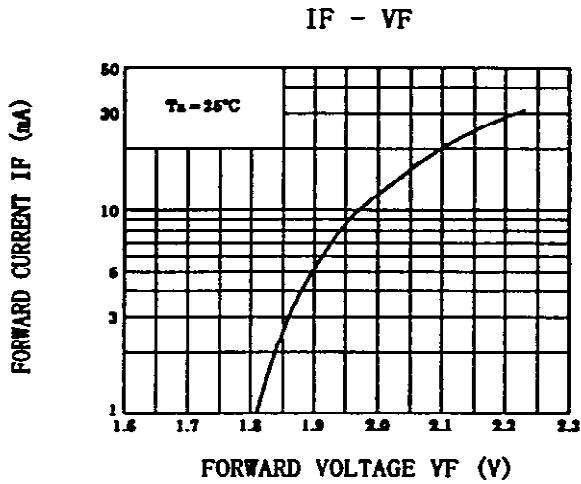

IF - VF

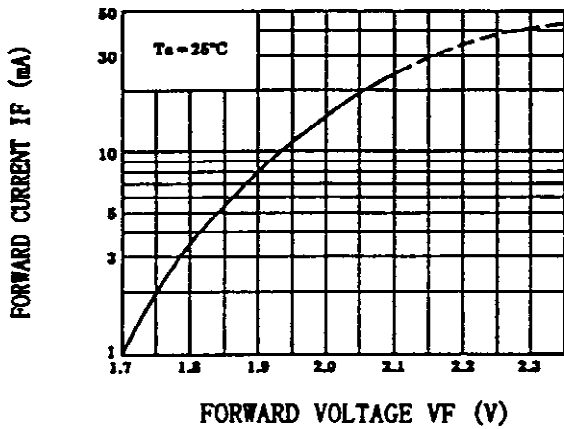

IV - IF

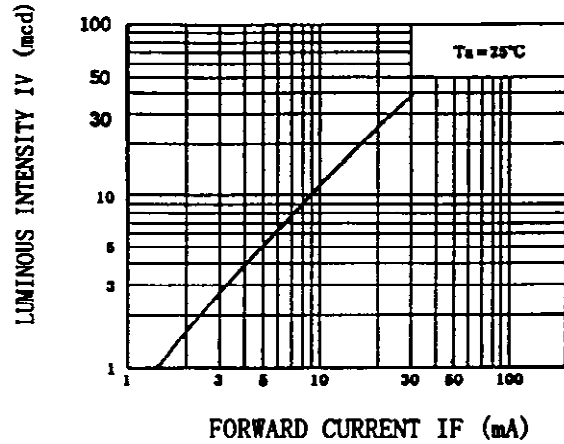

IV - Tc

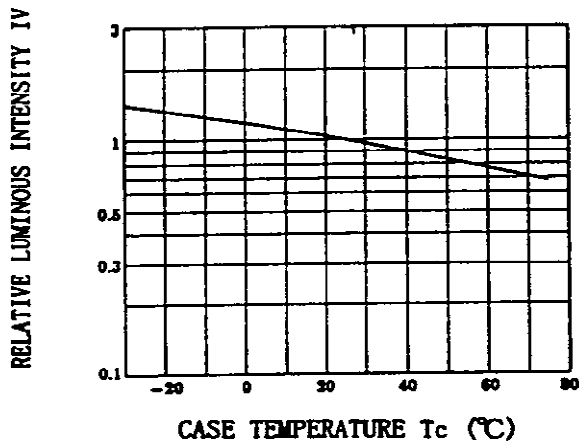

IV - λ

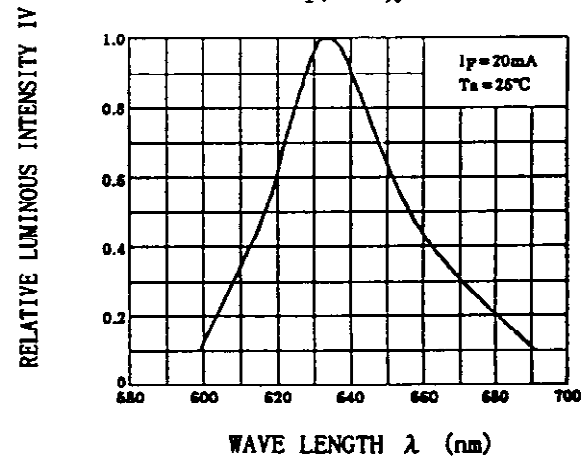

RADIATION PATTERN

$T_a = 25^\circ\text{C}$

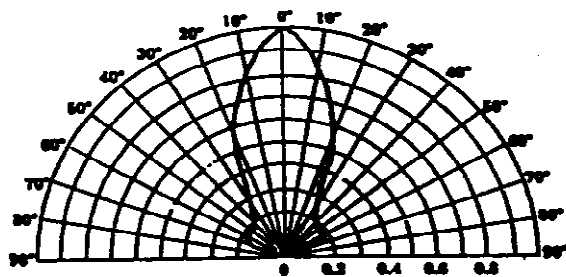

IF - Ta

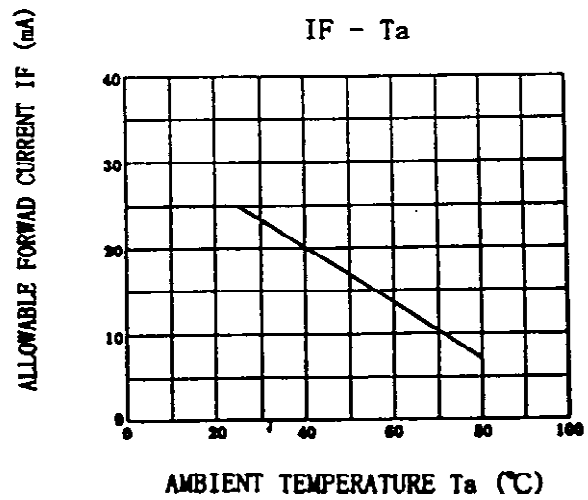

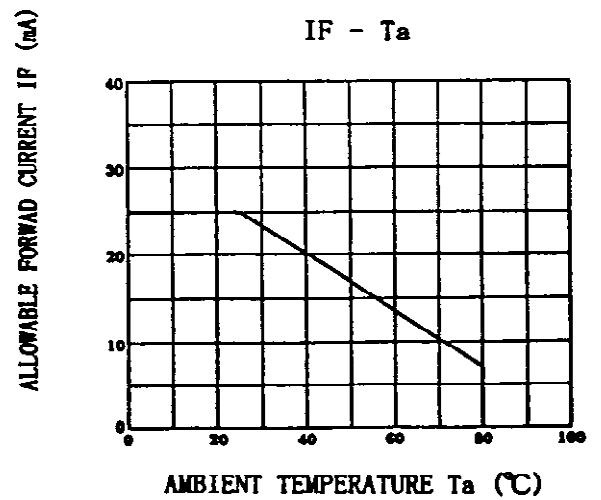
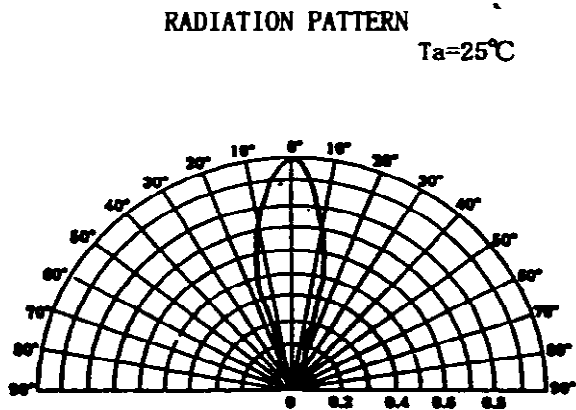
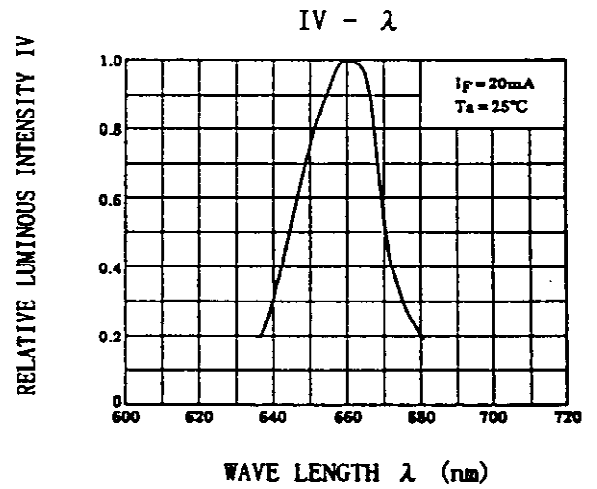
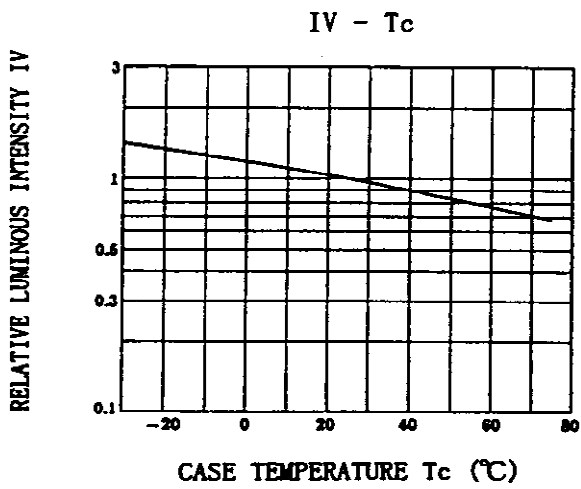
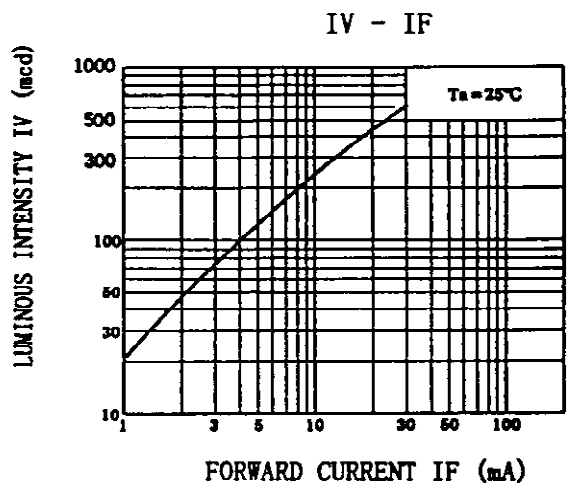
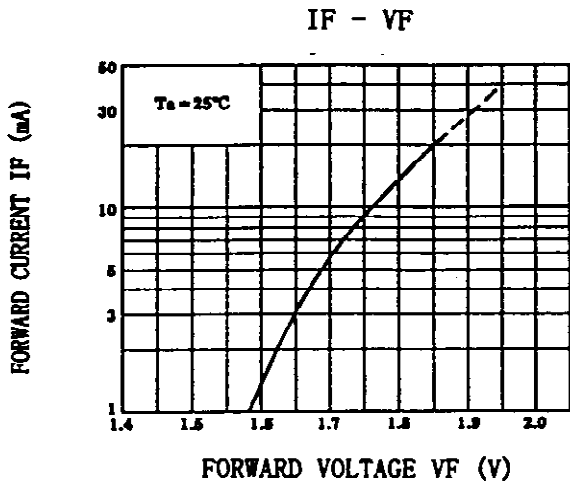

Taping Specifications:

Unit:mm

Dimensions of reel

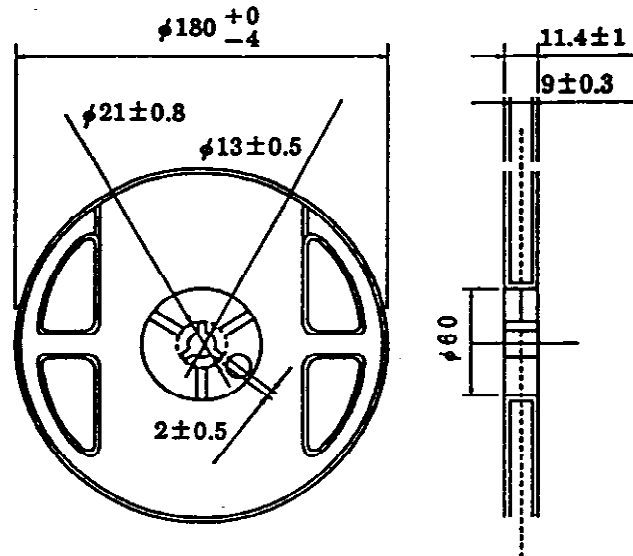

Dimensions of tape

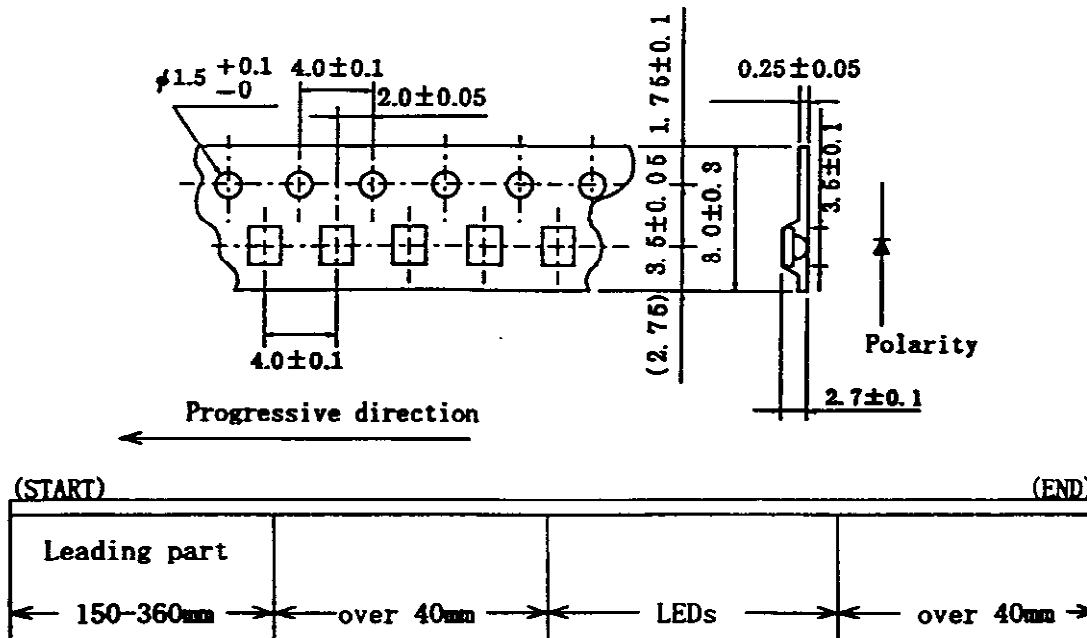

Loaded quantity per reel : 1,000 PCS

Packaging

LEDs are packed in an aluminum envelope with silicate to avoid the moisture absorption. After opening the package, storing at following condition is recommended since air extension at soldering according to the moisture absorption influences optical characteristics:

- Temperature 5 ~ 30°C
- Humidity 60% RH (MAX.)

Please execute baking if it has been 6 months under packed or 1 week under opened. Recommended baking condition: 60°C, over 12 hours.

Soldering

1. Reflow soldering:

- * It is recommended to use a reflow furnace of the upper and lower heater type.
- * The temperature profile as shown in Fig. 1 is recommended for soldering LEDs by the reflow furnace.

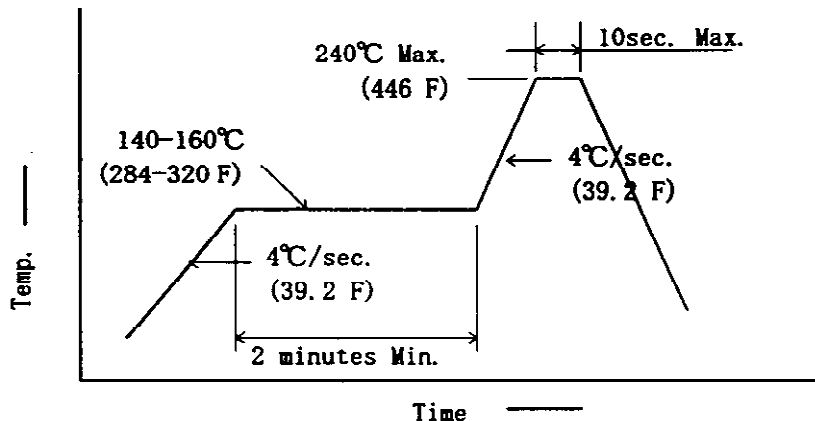

<Fig. 1>

<Recommend soldering pattern>

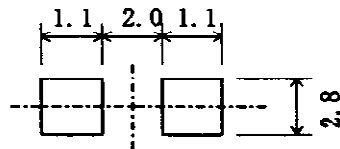

<p>Revision by manual soldering</p>	<p>: Soldering iron</p> <p>Temperature</p> <p>Time</p>	<p>Less than 25W</p> <p>Lower than 300°C</p> <p>Within 3 seconds</p>
--	---	---

2. Post solder cleaning:

When cleaning after soldering is needed, the following condition must be adhered to.

- Cleaning solvents: AK225 or Alcohol
- Temperature: 50°C (122°F) MAX. for 30 seconds, or
30°C (86°F) MAX. for 3 minutes MAX.
- Ultrasonic: 300W MAX.

Precaution for Mounting

1. No force to plastic part of LED when LED is under high temperature.
2. No friction using a hard thing to avoid injuring plastic part of LED.
3. No contact between LED and the other parts, when installing an assembled board into the set.