

9-36V ProLynx™ 5A: Non-Isolated DC-DC Power Modules

9Vdc –36Vdc input; 3Vdc to 18Vdc output; 5A to 2.5A Output Current



RoHS Compliant

Applications

- Industrial equipment
- Distributed power architectures
- Intermediate bus voltage applications
- Telecommunications equipment

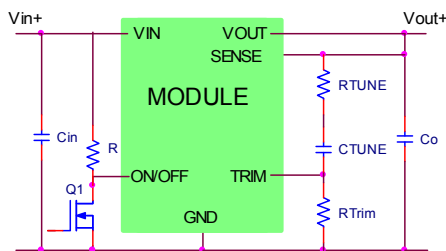

Description

The 9-36V ProLynx™ series of power modules are non-isolated dc-dc converters that can deliver up to 5A of output current. These modules operate over an extra wide range of input voltage ($V_{IN} = 9Vdc - 36Vdc$) and provide a precisely regulated output voltage from 3Vdc to 18Vdc, programmable via an external resistor. Two new features added with this family of products are the ability to externally tune the voltage control loop and a variable current limit inversely dependent on output voltage. Other features include remote On/Off, adjustable output voltage, over current and over temperature protection. The Tunable Loop™, allows the user to optimize the dynamic response of the converter to match the load with reduced amount of output capacitance leading to savings on cost and PWB area and AutoLimit enables the module to deliver the max possible output power across the entire voltage range.

Features

- Compliant to RoHS EU Directive 2002/95/EC (Z versions)
- Compatible in a Pb-free or SnPb reflow environment (Z versions)
- Extra Wide Input voltage range (9Vdc–36Vdc)
- Output voltage programmable from 3Vdc to 18 Vdc via external resistor
- Tunable Loop™ to optimize dynamic output voltage response
- Patent Pending AutoLimit automatic scaling of current limit with output voltage
- Output overcurrent protection (non-latching)
- Overtemperature protection
- Remote On/Off
- Remote Sense
- Small size: 20.3 mm x 11.4 mm x 8.5 mm (0.8 in x 0.45 in x 0.335 in)
- Wide operating temperature range (-40°C to 85°C)
- UL* 60950-1 Recognized, CSA† C22.2 No. 60950-1-03 Certified, and VDE‡ 0805:2001-12 (EN60950-1) Licensed
- ISO** 9001 and ISO 14001 certified manufacturing facilities

* UL is a registered trademark of Underwriters Laboratories, Inc.

† CSA is a registered trademark of Canadian Standards Association.

‡ VDE is a trademark of Verband Deutscher Elektrotechniker e.V.

** ISO is a registered trademark of the International Organization of Standards

Absolute Maximum Ratings

Stresses in excess of the absolute maximum ratings can cause permanent damage to the device. These are absolute stress ratings only, functional operation of the device is not implied at these or any other conditions in excess of those given in the operations sections of the data sheet. Exposure to absolute maximum ratings for extended periods can adversely affect the device reliability.

Parameter	Device	Symbol	Min	Max	Unit
Input Voltage Continuous	All	V_{IN}	-0.3	36	Vdc
Operating Ambient Temperature (see Thermal Considerations section)	All	T_A	-40	85	°C
Storage Temperature	All	T_{stg}	-55	125	°C

Electrical Specifications

Unless otherwise indicated, specifications apply over all operating input voltage, resistive load, and temperature conditions.

Parameter	Device	Symbol	Min	Typ	Max	Unit
Operating Input Voltage	All	V_{IN}	9	—	36	Vdc
Maximum Input Current ($V_{IN}=9V$ to 36V, $I_O=I_{O,max}$)	All	$I_{IN,max}$			5	Adc
Input No Load Current ($V_{IN} = 28V$, $I_O = 0$, module enabled)	$V_{O,set} = 3Vdc$	$I_{IN,No load}$		26		mA
($V_{IN} = 28V$, $I_O = 0$, module enabled)	$V_{O,set} = 18Vdc$	$I_{IN,No load}$		50		mA
Input Stand-by Current ($V_{IN} = 28Vdc$, module disabled)	All	$I_{IN,stand-by}$		3		mA
Inrush Transient	All	I^2t			0.5	A ² s
Input Reflected Ripple Current, peak-to-peak (5Hz to 20MHz, 1 μ H source impedance; $V_{IN}=0$ to 36V, $I_O=I_{O,max}$; See Test Configurations)	All				95	mAp-p
Input Ripple Rejection (120Hz)	All		-24	-45	-60	dB

CAUTION: This power module is not internally fused. An input line fuse must always be used.

This power module can be used in a wide variety of applications, ranging from simple standalone operation to an integrated part of sophisticated power architecture. To preserve maximum flexibility, internal fusing is not included; however, to achieve maximum safety and system protection, always use an input line fuse. The safety agencies require a fast-acting fuse with a maximum rating of 8 A (see Safety Considerations section). Based on the information provided in this data sheet on inrush energy and maximum dc input current, the same type of fuse with a lower rating can be used. Refer to the fuse manufacturer's data sheet for further information.

Electrical Specifications (continued)

Parameter	Device	Symbol	Min	Typ	Max	Unit
Output Voltage Set-point	All	$V_{O, set}$	-2.0		+2.0	% $V_{O, set}$
Output Voltage (Over all operating input voltage, resistive load, and temperature conditions until end of life)	All	$V_{O, set}$	-2.5	—	+2.5	% $V_{O, set}$
Adjustment Range (elected by an external resistor) (Some output voltages may not be possible depending on the input voltage – see Feature Descriptions Section)	All	V_O	3		18	Vdc
Output Regulation						
Line ($V_{IN}=V_{IN, min}$ to $V_{IN, max}$)	All			—	0.4	% $V_{O, set}$
Load ($I_O=I_{O, min}$ to $I_{O, max}$)	All			—	0.4	% $V_{O, set}$
Temperature ($T_{ref}=T_{A, min}$ to $T_{A, max}$)	All			—	0.4	% $V_{O, set}$
Remote Sense Range	All				0.5	Vdc
Output Ripple and Noise on nominal output ($V_{IN}=V_{IN, nom}$ and $I_O=I_{O, min}$ to $I_{O, max}$ $C_o = 0.1\mu F // 10\mu F$ ceramic capacitors) Vout=3.3V, Vin=28V						
Peak-to-Peak (5Hz to 20MHz bandwidth)	All			45		mV _{pk-pk}
RMS (5Hz to 20MHz bandwidth)	All			14		mV _{rms}
Vout=18V, Vin=28V						
Peak-to-Peak (5Hz to 20MHz bandwidth)	All			143		mV _{pk-pk}
RMS (5Hz to 20MHz bandwidth)	All			47		mV _{rms}
External Capacitance ¹						
Without the Tunable Loop™						
ESR ≥ 1 mΩ	All	$C_{O, max}$	0	—	47	μF
ESR ≥ 10 mΩ	All	$C_{O, max}$	0	—	100	μF
With the Tunable Loop™						
ESR ≥ 0.15 mΩ	All	$C_{O, max}$	0	—	100	μF
ESR ≥ 10 mΩ	All	$C_{O, max}$	0	—	2000*	μF
Output Current ($V_O=3V$)	All	I_o	0		5	A _{dc}
$V_O=5V$	All	I_o	0		4.7	A _{dc}
$V_O=12V$	All	I_o	0		3.5	A _{dc}
$V_O=18V$	All	I_o	0		2.5	A _{dc}
Output Current Limit Inception (Hiccup Mode)	All	$I_{O, lim}$		160		% $I_{O, max}$
Output Short-Circuit Current ($V_O \leq 250mV$) (Hiccup Mode)	All	$I_{O, s/c}$		0.3		A _{dc}
Efficiency ($I_O=I_{O, max}$, $V_O=V_{O, set}$)						
$V_{IN}=12Vdc$, $T_A=25^\circ C$	$V_{O, set}=3.3Vdc$	η		91.0		%
$V_{IN}=12Vdc$, $T_A=25^\circ C$	$V_{O, set}=5Vdc$	η		93.3		%
$V_{IN}=28Vdc$, $T_A=25^\circ C$	$V_{O, set}=12Vdc$	η		94.7		%
$V_{IN}=28Vdc$, $T_A=25^\circ C$	$V_{O, set}=18Vdc$	η		95.9		%

¹ Depending on Input and Output Voltage, external capacitors require using the new Tunable Loop™ feature to ensure that the module is stable as well as getting the best transient response. See the Tunable Loop™ section for details.

* Larger values may be possible at specific output voltages. Please consult your Lineage Technical representative for additional details.

Electrical Specifications (continued)

Parameter	Device	Symbol	Min	Typ	Max	Unit
Switching Frequency	All	f_{sw}	—	300	—	kHz

General Specifications

Parameter	Min	Typ	Max	Unit
Calculated MTBF ($I_o=0.8I_{o,max}$, $T_A=40^\circ\text{C}$) Telcordia Issue 2 Method 1 Case 3		17,822,788		Hours
Weight	—	3.49 (0.123)	—	g (oz.)

Feature Specifications

Unless otherwise indicated, specifications apply over all operating input voltage, resistive load, and temperature conditions. See Feature Descriptions for additional information.

Parameter	Device	Symbol	Min	Typ	Max	Unit
On/Off Signal Interface ($V_{IN}=V_{IN, min}$ to $V_{IN, max}$; open collector or equivalent, Signal referenced to GND) Device is with suffix "4" – Positive Logic (See Ordering Information)						
Logic High (Module ON)						
Input High Current	All	I_{IH}		—	160	μA
Input High Voltage	All	V_{IH}	4.2	—	12	V
Logic Low (Module OFF)						
Input Low Current	All	I_{IL}	—	—	0.5	mA
Input Low Voltage	All	V_{IL}	-0.3	—	3.3	V
Device Code with no suffix – Negative Logic (See Ordering Information)						
Logic High (Module OFF)						
Input High Current	All	I_{IH}	—	—	1.6	mA
Input High Voltage	All	V_{IH}	1.5	—	36	Vdc
Logic Low (Module ON)						
Input low Current	All	I_{IL}	—	—	18	μA
Input Low Voltage	All	V_{IL}	-0.2	—	1	Vdc
Turn-On Delay and Rise Times						
($V_{IN}=V_{IN, nom}$, $I_O=I_{O, max}$, V_O to within $\pm 1\%$ of steady state)						
Case 1: On/Off input is enabled and then input power is applied (delay from instant at which $V_{IN} = V_{IN, min}$ until $V_O = 10\%$ of $V_{O, set}$)	All	Tdelay	—	9	—	msec
Case 2: Input power is applied for at least one second and then the On/Off input is enabled (delay from instant at which Von/Off is enabled until $V_O = 10\%$ of $V_{O, set}$)	All	Tdelay	—	7	—	msec
Output voltage Rise time (time for V_O to rise from 10% of $V_{O, set}$ to 90% of $V_{O, set}$)	All	Trise	—	8	—	msec
Output voltage overshoot ($T_A = 25^\circ C$ $V_{IN} = V_{IN, min}$ to $V_{IN, max}$, $I_O = I_{O, min}$ to $I_{O, max}$) With or without maximum external capacitance					3	% $V_{O, set}$
Over Temperature Protection (See Thermal Considerations section)	All	T_{ref}		130		$^\circ C$
Input Undervoltage Lockout						
Turn-on Threshold	All			7.5		Vdc
Turn-off Threshold	All			7.04		Vdc
Hysteresis	All			0.46		Vdc

Characteristic Curves

The following figures provide typical characteristics for the 9-36V MicroTLynx™ 5A at 3.3V_o and at 25°C.

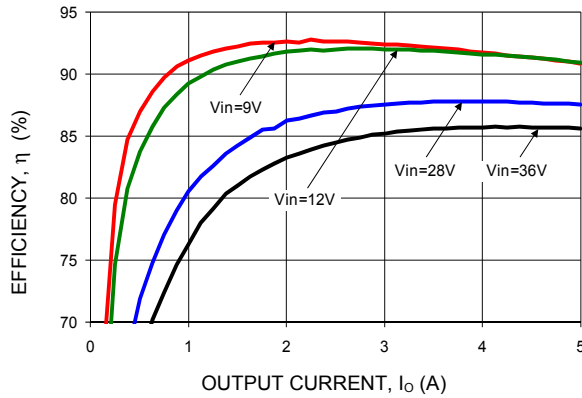

Figure 1. Converter Efficiency versus Output Current.

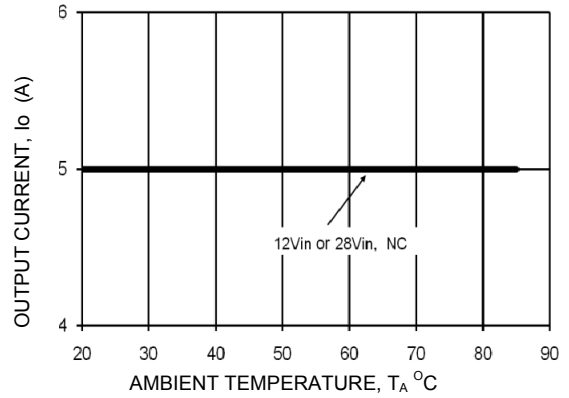

Figure 2. Derating Output Current versus Ambient Temperature and Airflow.

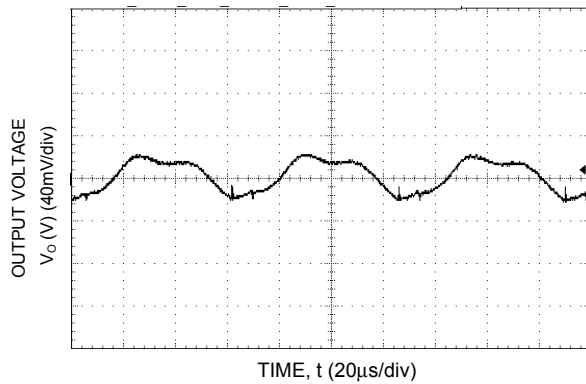

Figure 3. Typical output ripple and noise ($V_{IN} = 28V$, $I_o = I_{o,max}$).

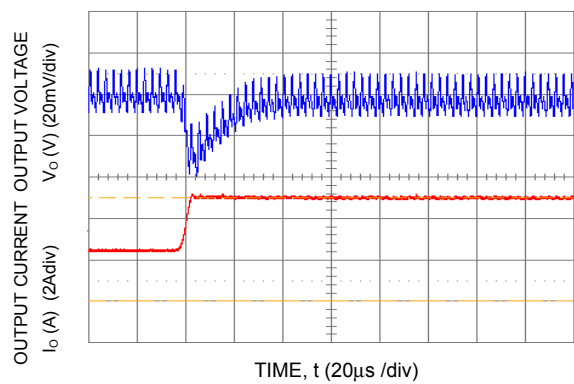

Figure 4. Transient Response to Dynamic Load Change from 50% to 100% at 28Vin, C_{ext} - 10uF ceramic + 330uF polymer, C_{Tune}=10nF & R_{Tune}=150Ω

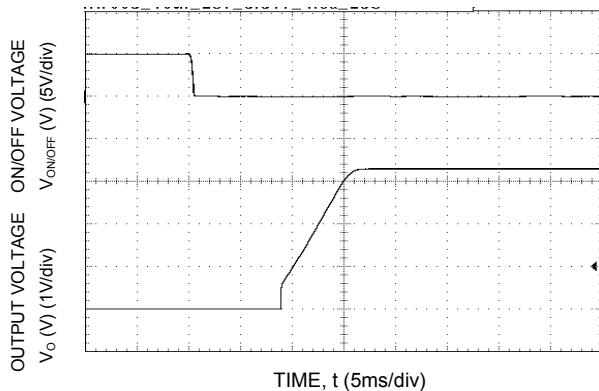

Figure 5. Typical Start-up Using On/Off Voltage ($I_o = I_{o,max}$).

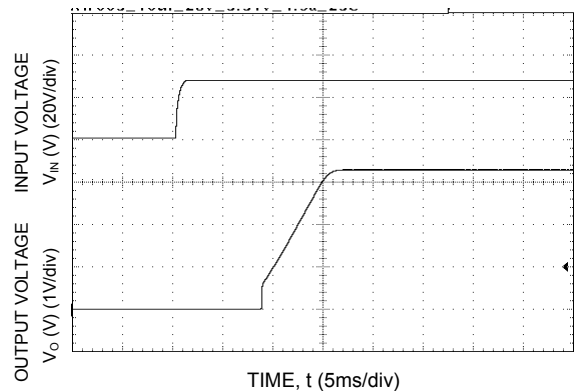

Figure 6. Typical Start-up Using Input Voltage ($V_{IN} = 28V$, $I_o = I_{o,max}$).

Characteristic Curves

The following figures provide typical characteristics for the 9-36V ProLynx™ 5A at 5Vo and at 25°C.

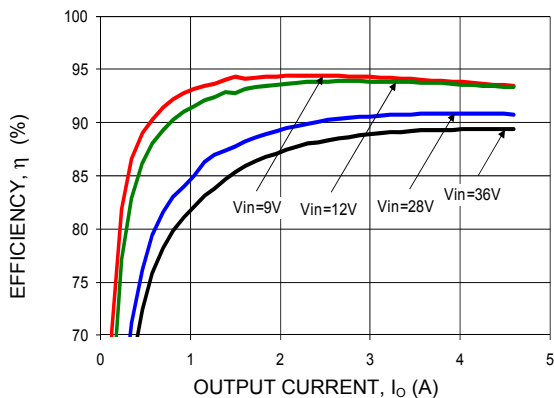

Figure 7. Converter Efficiency versus Output Current.

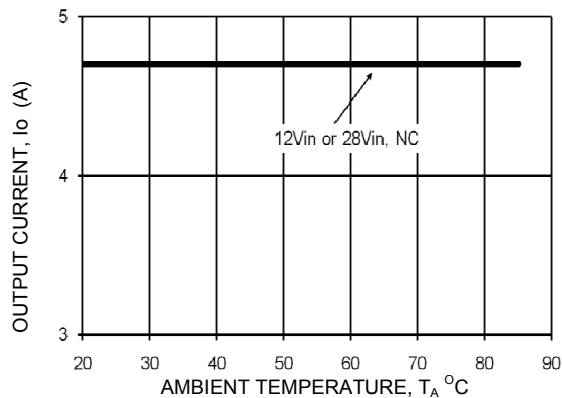

Figure 8. Derating Output Current versus Ambient Temperature and Airflow.

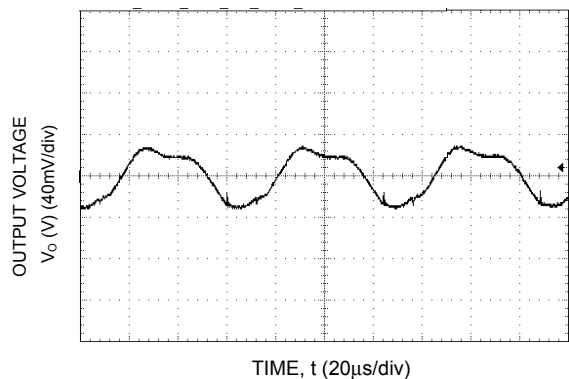

Figure 9. Typical output ripple and noise ($V_{IN} = 28V$, $I_o = I_{o,max}$).

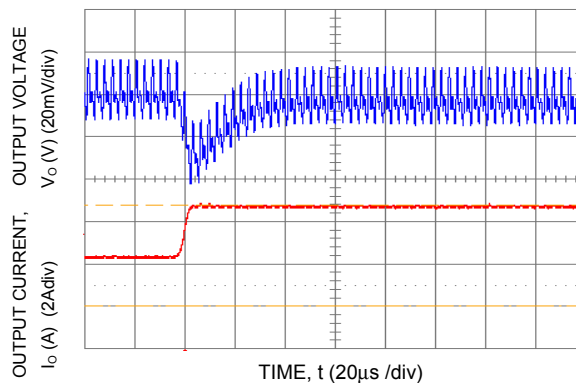

Figure 10. Transient Response to Dynamic Load Change from 50% to 100% at 28Vin, Cext - 10uF ceramic + 330uF polymer, CTune=10nF & RTune=150Ω

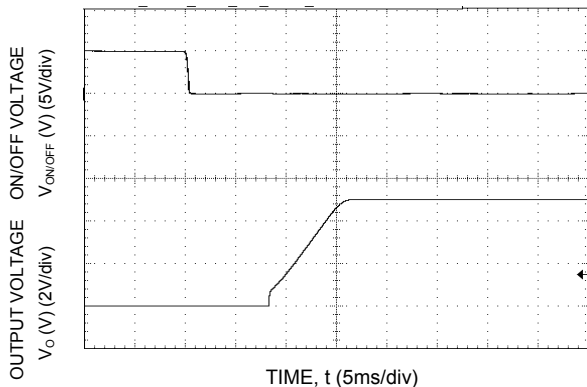

Figure 10. Typical Start-up Using On/Off Voltage ($I_o = I_{o,max}$).

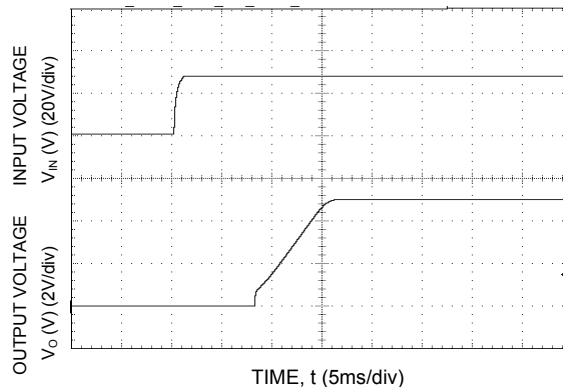

Figure 11. Typical Start-up Using Input Voltage ($V_{IN} = 28V$, $I_o = I_{o,max}$).

Characteristic Curves

The following figures provide typical characteristics for the 9-36V ProLynx™ 5A at 12V_o and at 25°C.

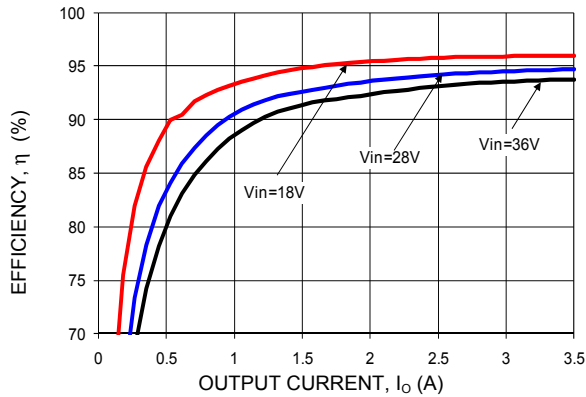

Figure 12. Converter Efficiency versus Output Current.

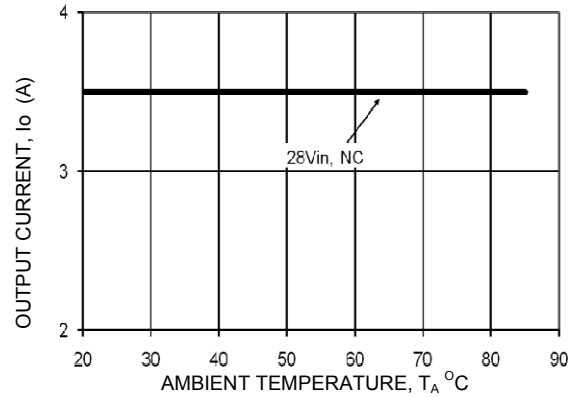

Figure 13. Derating Output Current versus Ambient Temperature and Airflow.

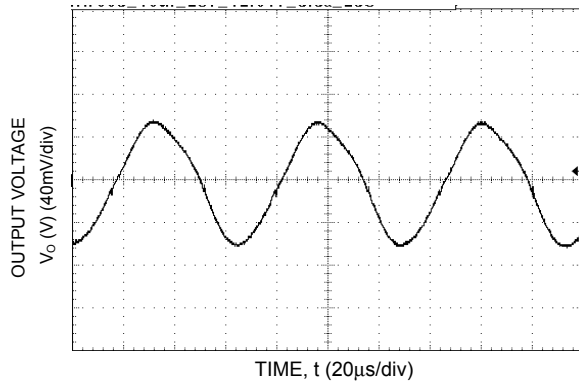

Figure 14. Typical output ripple and noise ($V_{IN} = 28V$, $I_o = I_{o,max}$).

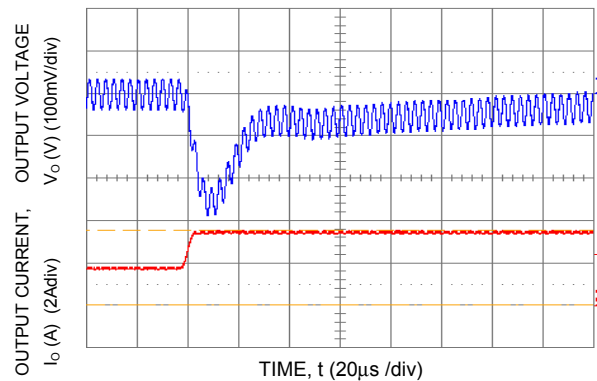

Figure 15. Transient Response to Dynamic Load Change from 50% to 100% at 28Vin, C_{ext} - 3x10uF ceramic, C_{Tune}=470pF & R_{Tune}=150Ω

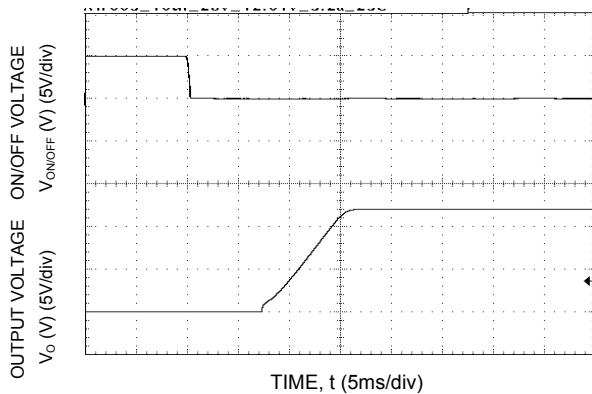

Figure 16. Typical Start-up Using On/Off Voltage ($I_o = I_{o,max}$).

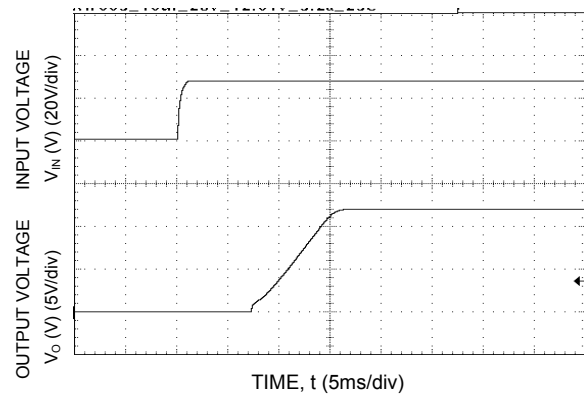

Figure 17. Typical Start-up Using Input Voltage ($V_{IN} = 28V$, $I_o = I_{o,max}$).

Characteristic Curves

The following figures provide typical characteristics for the 9-36V ProLynx™ 5A at 18Vo and at 25°C.

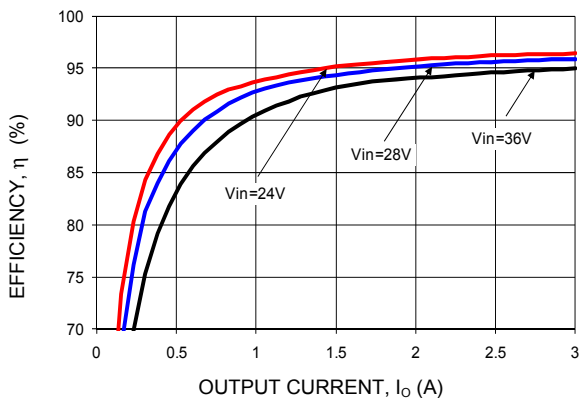

Figure 18. Converter Efficiency versus Output Current.

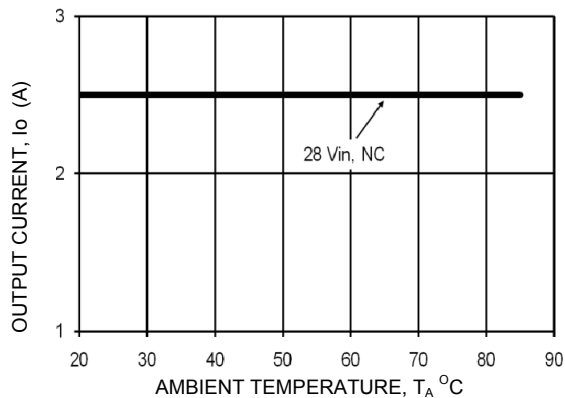

Figure 19. Derating Output Current versus Ambient Temperature and Airflow.

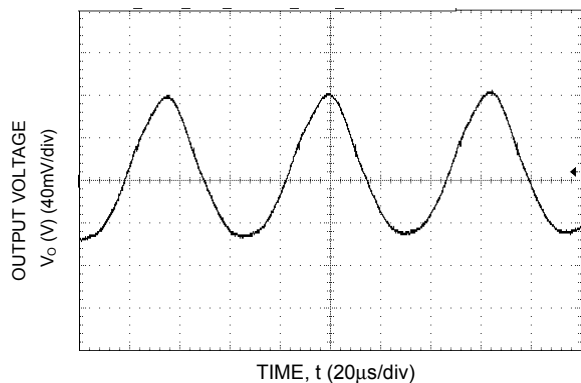

Figure 20. Typical output ripple and noise ($V_{IN} = 28V$, $I_o = I_{o,max}$).

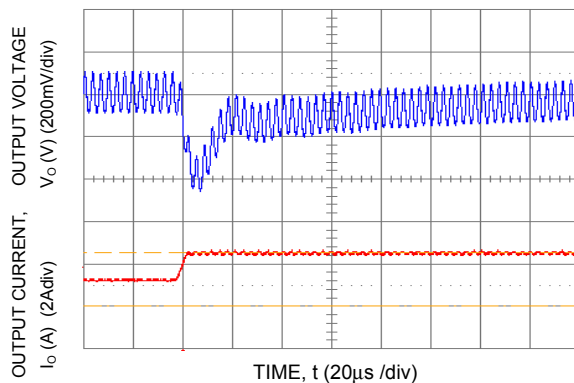

Figure 21. Transient Response to Dynamic Load Change from 50% to 100% at 28Vin, Cext - 1x10uF ceramic, CTune=150pF & RTune=220Ω

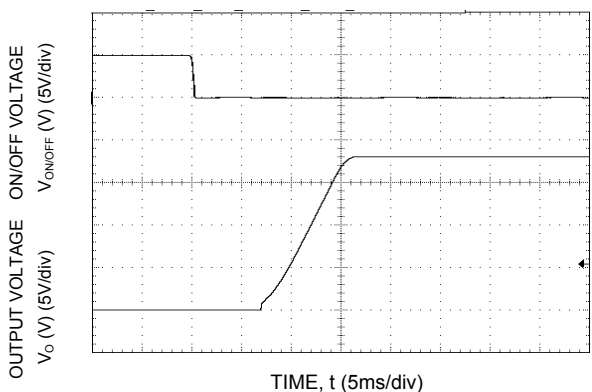

Figure 22. Typical Start-up Using On/Off Voltage ($I_o = I_{o,max}$).

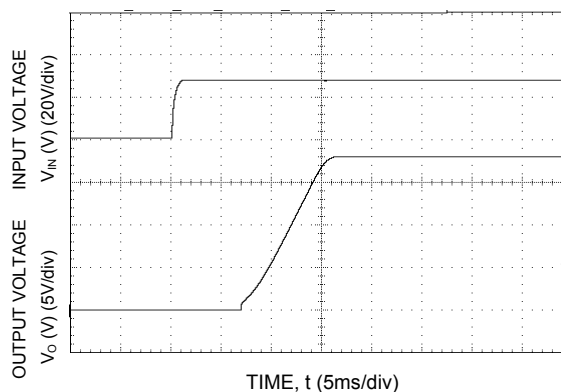
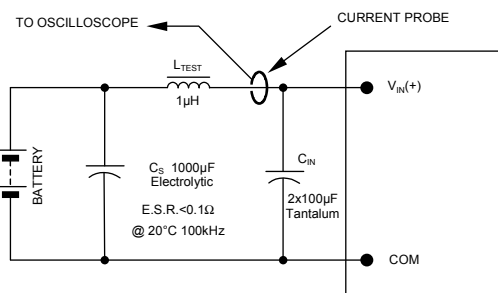

Figure 23. Typical Start-up Using Input Voltage ($V_{IN} = 28V$, $I_o = I_{o,max}$).

Test Configurations



NOTE: Measure input reflected ripple current with a simulated source inductance (L_{TEST}) of 1µH. Capacitor C_S offsets possible battery impedance. Measure current as shown above.

Figure 25. Input Reflected Ripple Current Test Setup.

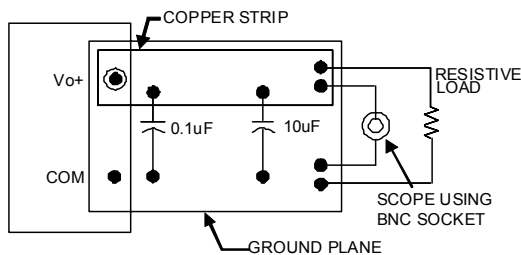

NOTE: All voltage measurements to be taken at the module terminals, as shown above. If sockets are used then Kelvin connections are required at the module terminals to avoid measurement errors due to socket contact resistance.

Figure 26. Output Ripple and Noise Test Setup.

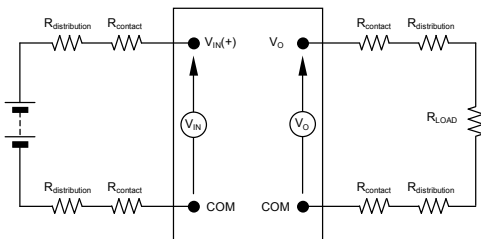

NOTE: All voltage measurements to be taken at the module terminals, as shown above. If sockets are used then Kelvin connections are required at the module terminals to avoid measurement errors due to socket contact resistance.

Figure 27. Output Voltage and Efficiency Test Setup.

$$\text{Efficiency } \eta = \frac{V_O \cdot I_O}{V_{IN} \cdot I_{IN}} \times 100 \%$$

Design Considerations

Input Filtering

The 9-36V ProLynx™ module should be connected to a low ac-impedance source. A highly inductive source can affect the stability of the module. An input capacitance must be placed directly adjacent to the input pin of the module, to minimize input ripple voltage and ensure module stability.

To minimize input voltage ripple, ceramic capacitors are recommended at the input of the module. Figure 28 shows the input ripple voltage for various output voltages at maximum load current with 2x10 µF or 3x10 µF ceramic capacitors and an input of 12V, while Fig. 29 shows the input ripple for an input voltage of 28V.

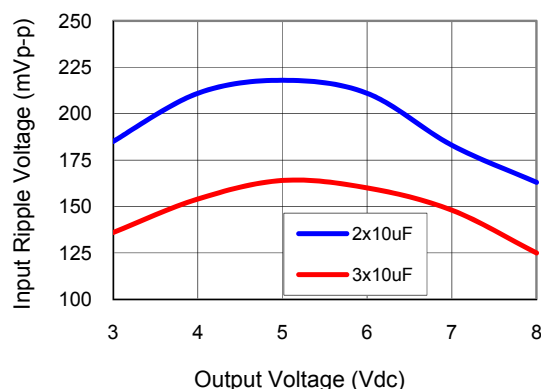

Figure 28. Input ripple voltage for various output voltages with 2x10 µF or 3x10 µF ceramic capacitors at the input (maximum load). Input voltage is 12V.

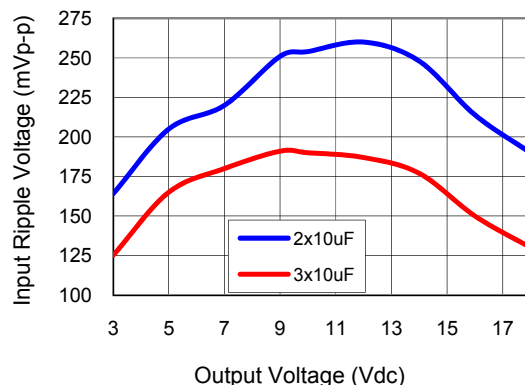

Figure 29. Input ripple voltage for various output voltages with 2x10 µF or 3x10 µF ceramic capacitors at the input (maximum load). Input voltage is 28V.

Output Filtering

The 9-36V ProLynx™ modules are designed for low output ripple voltage and will meet the maximum output ripple specification with 0.1 μF ceramic and 10 μF ceramic capacitors at the output of the module. However, additional output filtering may be required by the system designer for a number of reasons. First, there may be a need to further reduce the output ripple and noise of the module. Second, the dynamic response characteristics may need to be customized to a particular load step change.

To reduce the output ripple and improve the dynamic response to a step load change, additional capacitance at the output can be used. Low ESR polymer and ceramic capacitors are recommended to improve the dynamic response of the module. Figures 30 and 31 provide output ripple information for different external capacitance values at various V_o and for full load currents. For stable operation of the module, limit the capacitance to less than the maximum output capacitance as specified in the electrical specification table. Optimal performance of the module can be achieved by using the Tunable Loop™ feature described later in this data sheet.

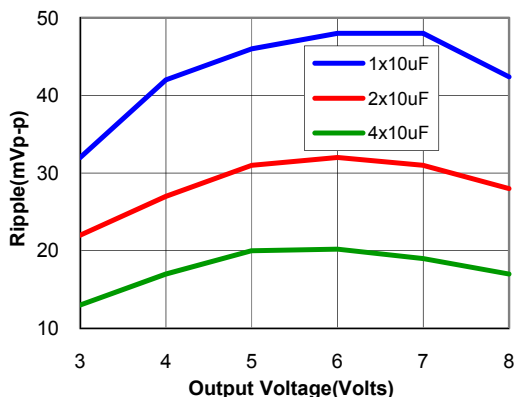

Figure 30. Output ripple voltage for various output voltages with external 1x10 μF , 2x10 μF or 4x10 μF ceramic capacitors at the output (max. load). Input voltage is 12V.

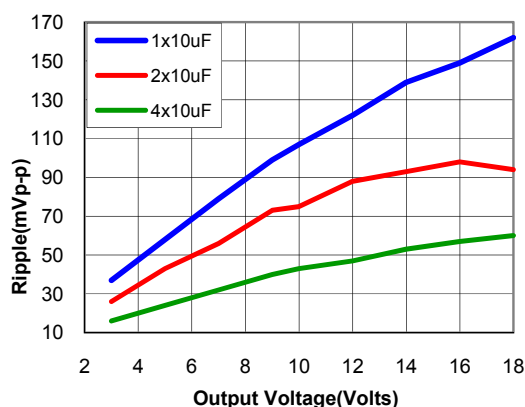

Figure 31. Output ripple voltage for various output voltages with external 1x10 μF , 2x10 μF or 4x10 μF ceramic capacitors at the output (max. load). Input voltage is 28V.

Safety Considerations

For safety agency approval the power module must be installed in compliance with the spacing and separation requirements of the end-use safety agency standards, i.e., UL 60950-1, CSA C22.2 No. 60950-1-03, and VDE 0850:2001-12 (EN60950-1) Licensed.

For the converter output to be considered meeting the requirements of safety extra-low voltage (SELV), the input must meet SELV requirements. The power module has extra-low voltage (ELV) outputs when all inputs are ELV.

The input to these units is to be provided with a fast-acting fuse with a maximum rating of 8A in the positive input lead.

Feature Descriptions

Remote Enable

The 9-36V ProLynx™ modules feature an On/Off pin for remote On/Off operation. Two On/Off logic options are available. In the Positive Logic On/Off option, (device code suffix “4” – see Ordering Information), the module turns ON during a logic High on the On/Off pin and turns OFF during a logic Low. With the Negative Logic On/Off option, (no device code suffix, see Ordering Information), the module turns OFF during logic High and ON during logic Low. The On/Off signal is always referenced to ground.

For positive logic modules, the circuit configuration for using the On/Off pin is shown in Figure 32. When the external transistor Q1 is in the OFF state, the ON/OFF pin is pulled high and transistor Q2 is OFF leading to Q3 also being OFF which turns the module ON. The external resistor R_{pullup} (100k recommended) must be sized so that $V_{ON/OFF}$ is never more than 12V when Q1 is OFF. In particular, if V_{pullup} is made the same as the input voltage V_{in} , the resistor R_{pullup} must be large enough so that $V_{ON/OFF}$ is never more than 12V.

For negative logic On/Off modules, the circuit configuration is shown in Fig. 33. When the external transistor Q1 is in the ON state, the ON/OFF pin is pulled low causing transistor Q2 to be OFF and the module to be turned ON. To turn the module OFF, Q1 is turned OFF, causing the ON/OFF pin to be pulled high through the module's internal pullup resistor, causing Q2 to be ON and the module to be turned OFF. Leaving the On/Off pin floating will leave the module in an OFF state.

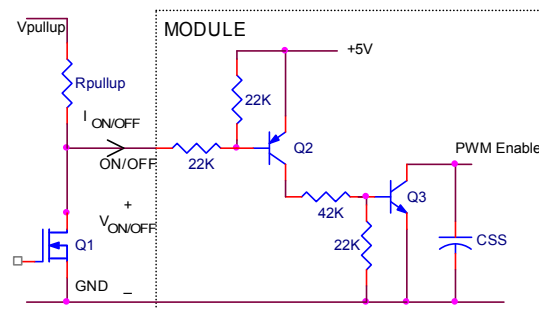

Figure 32. Circuit configuration for using positive On/Off logic.

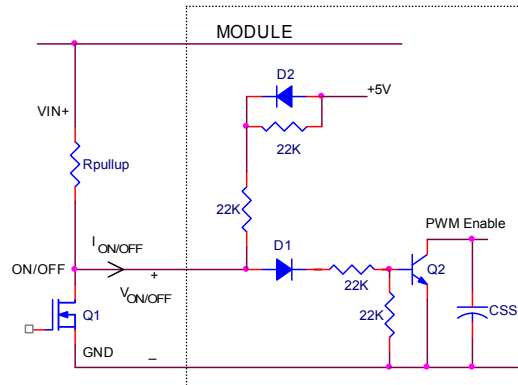

Figure 33. Circuit configuration for using negative On/Off logic.

Overcurrent Protection

To provide protection in a fault (output overload) condition, the unit is equipped with internal current-limiting circuitry and can endure current limiting continuously. At the point of current-limit inception, the unit enters hiccup mode. The unit operates normally once the output current is brought back into its specified range. The 9-36V ProLynx modules employ an innovative, patent pending, ‘AutoLimit’ capability. This results in automatic scaling of current limit with output voltage through an inverse relationship of the current limit threshold with the output voltage. This feature shown graphically in Fig. 34, allows higher output currents to be drawn from the module at lower output voltages thereby optimizing the power delivery capability of the module.

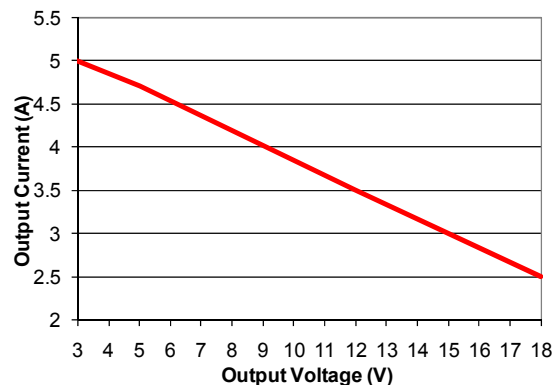

Figure 34. Graph showing maximum output current capability at different output voltages.

Over Temperature Protection

To provide protection in a fault condition, the unit is equipped with a thermal shutdown circuit. The unit will shutdown if the overtemperature threshold of 130°C is exceeded at the thermal reference point T_{ref} . The thermal shutdown is not intended as a guarantee that the unit will survive temperatures beyond its rating.

Once the unit goes into thermal shutdown it will then wait to cool before attempting to restart.

Input Undervoltage Lockout

At input voltages below the input undervoltage lockout limit, the module operation is disabled. The module will begin to operate at an input voltage above the undervoltage lockout turn-on threshold.

Output Voltage Programming

The output voltage of the 9-36V ProLynx™ module can be programmed to any voltage from 3Vdc to 18Vdc by connecting a resistor between the Trim and GND pins of the module. Certain restrictions apply on the output voltage set point depending on the input voltage. These are shown in the Output Voltage vs. Input Voltage Set Point Area plot in Fig. 35.

Without an external resistor between Trim and GND pins, the output of the module will be 0.7Vdc. To calculate the value of the trim resistor, R_{trim} for a desired output voltage, use the following equation:

$$R_{trim} = \left[\frac{70}{(V_o - 0.7)} \right] k\Omega$$

R_{trim} is the external resistor in $k\Omega$, and V_o is the desired output voltage.

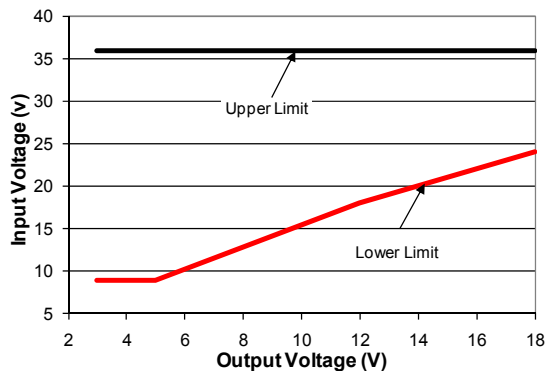

Figure 35. Output Voltage vs. Input Voltage Set Point Area plot showing limits where the output voltage can be set for different input voltages.

Table 1 provides R_{trim} values required for some common output voltages.

Table 1

$V_{o, set}$ (V)	R_{trim} (K Ω)
3.3	26.92
5	16.27
6	13.20
9	8.43
12	6.19
15	4.89
18	4.04

By using a $\pm 0.5\%$ tolerance trim resistor with a TC of ± 100 ppm, a set point tolerance of $\pm 1.5\%$ can be achieved as specified in the electrical specification.

Remote Sense

The 9-36V ProLynx™ power modules have a Remote Sense feature to minimize the effects of distribution losses by regulating the voltage between the VS+ and Vo pin. The voltage between the VS+ pin and Vo pin should not exceed 0.5V.

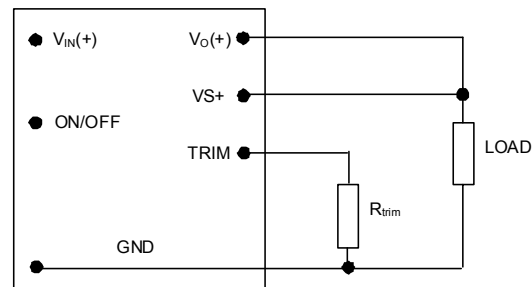

Figure 36. Circuit configuration for programming output voltage using an external resistor.

Voltage Margining

Output voltage margining can be implemented in the 9-36V ProLynx™ modules by connecting a resistor, $R_{margin-up}$, from the Trim pin to the ground pin for margining-up the output voltage and by connecting a resistor, $R_{margin-down}$, from the Trim pin to output pin for margining-down. Figure 37 shows the circuit configuration for output voltage margining. The POL Programming Tool, available at www.lineagepower.com under the Design Tools section, also calculates the values of $R_{margin-up}$ and $R_{margin-down}$ for a specific output voltage and % margin. Please consult your local Lineage Power technical representative for additional details.

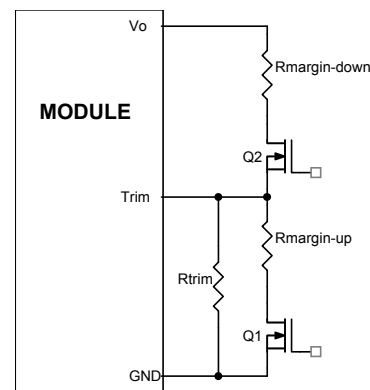

Figure 37. Circuit Configuration for margining Output voltage

Tunable Loop™

The 9-36V ProLynx™ modules have a new feature that optimizes transient response of the module called Tunable Loop™.

External capacitors are usually added to the output of the module for two reasons: to reduce output ripple and noise (see Figs 30 and 31) and to reduce output voltage deviations from the steady-state value in the presence of dynamic load current changes. Adding external capacitance however affects the voltage control loop of the module, typically causing the loop to slow down with sluggish response. Larger values of external capacitance could also cause the module to become unstable.

The Tunable Loop™ allows the user to externally adjust the voltage control loop to match the filter network connected to the output of the module. The Tunable Loop™ is implemented by connecting a series R-C between the SENSE and TRIM pins of the module, as shown in Fig. 38. This R-C allows the user to externally adjust the voltage loop feedback compensation of the module.

Recommended values of R_{TUNE} and C_{TUNE} for different output capacitor combinations are given in Tables 2, 3 and 4. Tables 2 and 3 show recommended values of R_{TUNE} and C_{TUNE} for different values of ceramic output capacitors up to 100 μ F that might be needed for an application to meet output ripple and noise requirements. Selecting R_{TUNE} and C_{TUNE} according to Tables 2 and 3 will ensure stable operation of the module

In applications with tight output voltage limits in the presence of dynamic current loading, additional output capacitance will be required. Table 4 lists recommended values of R_{TUNE} and C_{TUNE} in order to meet 2% output voltage deviation limits for some common output voltages in the presence of a 50% of full load step change with an input voltage of 12 or 28V.

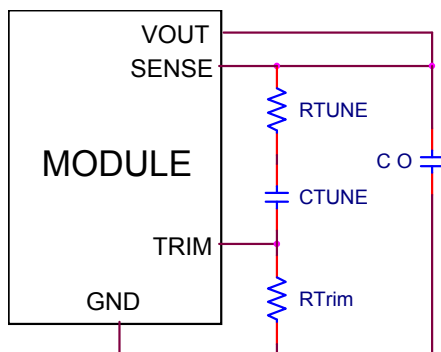

Figure 38. Circuit diagram showing connection of R_{TUNE} and C_{TUNE} to tune the control loop of the module.

Please contact your Lineage Power technical representative to obtain more details of this feature as well as for guidelines on how to select the right value of external R-C to tune the module for best transient performance and stable operation for other output capacitance values or input voltages other than 12 / 28V.

Table 2. General recommended values of R_{TUNE} and C_{TUNE} for $V_{in}=12V$ and various external ceramic capacitor combinations.

$V_o=5V$

C_o	1x10 μ F	2x10 μ F	4x10 μ F	6x10 μ F	10x10 μ F
R_{TUNE}	330	330	220	150	150
C_{TUNE}	1000pF	1500pF	2200pF	3300pF	4700pF

Table 3. General recommended values of R_{TUNE} and C_{TUNE} for $V_{in}=28V$ and various external ceramic capacitor combinations.

$V_o=5V$

C_o	1x10 μ F	2x10 μ F	4x10 μ F	6x10 μ F	10x10 μ F
R_{TUNE}	330	220	220	150	150
C_{TUNE}	220pF	390pF	680pF	1000pF	1800pF

$V_o=12V$

C_o	1x10 μ F	2x10 μ F	4x10 μ F	6x10 μ F	10x10 μ F
R_{TUNE}	330	220	220	150	150
C_{TUNE}	150pF	220pF	470pF	1000pF	1500pF

Table 4. Recommended values of R_{TUNE} and C_{TUNE} to obtain transient deviation of 2% of V_{out} for a 50% of full load step.

V_{in}	12V		28V			
	3.3V	5V	3.3V	5V	12V	18V
ΔI	2.5A	2A	2.5A	2A	1.5A	1A
C_o	1x330 μ F polymer	1x330 μ F polymer	1x330 μ F polymer	1x330 μ F polymer	3x10 μ F	1x10 μ F
R_{TUNE}	150	150	150	150	150	220
C_{TUNE}	22nF	22nF	10nF	10nF	470pF	150pF
ΔV	36mV	28mV	31mV	25mV	222mV	240mV

Thermal Considerations

Power modules operate in a variety of thermal environments; however, sufficient cooling should always be provided to help ensure reliable operation.

Considerations include ambient temperature, airflow, module power dissipation, and the need for increased reliability. A reduction in the operating temperature of the module will result in an increase in reliability. The thermal data presented here is based on physical measurements taken in a wind tunnel. The test set-up is shown in Figure 39. The preferred airflow direction for the module is in Figure 40. The derating data applies to airflow in either direction of the module's short axis.

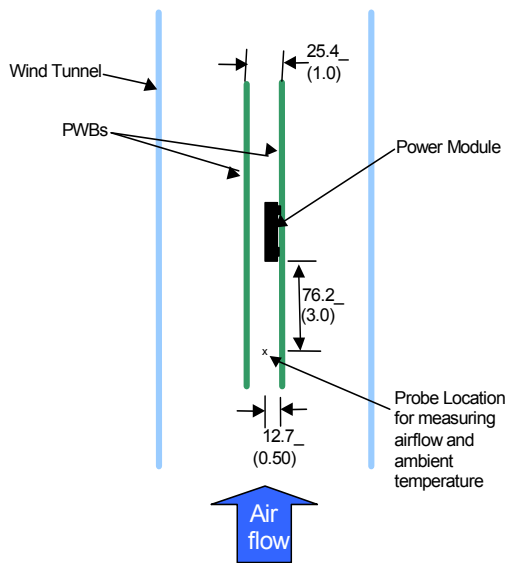

Figure 39. Thermal Test Setup.

The thermal reference points, T_{ref} used in the specifications are also shown in Figure 40. For reliable operation the temperatures at these points should not exceed 115°C. The output power of the module should not exceed the rated power of the module ($V_{o,set} \times I_{o,max}$).

Please refer to the Application Note “Thermal Characterization Process For Open-Frame Board-Mounted Power Modules” for a detailed discussion of thermal aspects including maximum device temperatures.

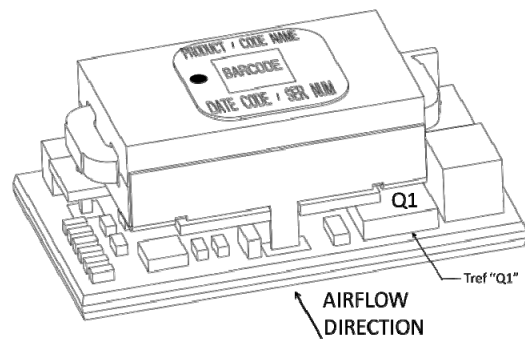
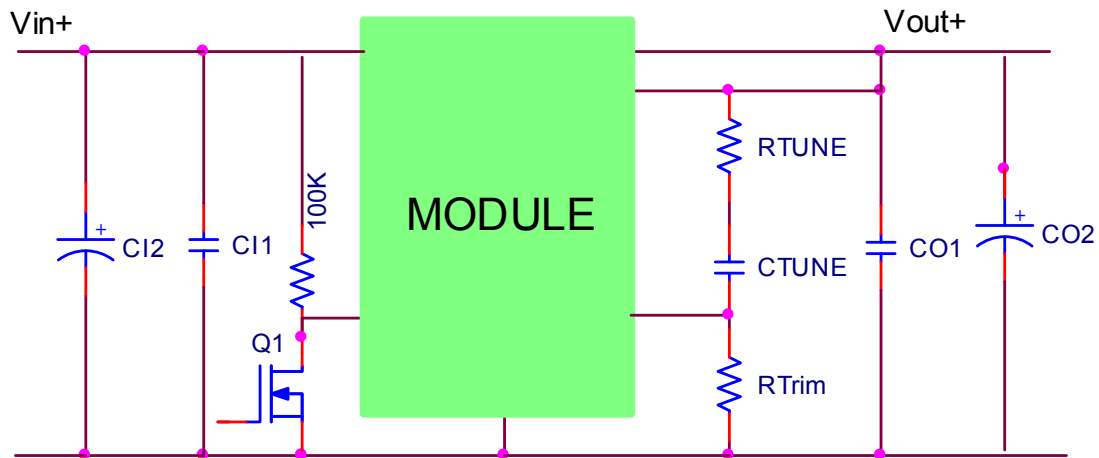

Figure 40. Preferred airflow direction and location of hot-spot of the module (T_{ref}).

Example Application Circuit

Requirements:

- Vin:** 28V
- Vout:** 12V
- Iout:** 2.6A max., worst case load transient is from 1.75A to 2.6A
- ΔVout:** 1.5% of Vout (180mV) for worst case load transient
- Vin, ripple:** 1.5% of Vin (420mV, p-p)



- C11 2 x 10μF/50V ceramic capacitor (e.g. Murata GRM32ER71H106K)
- C12 47μF/16V bulk electrolytic
- CO1 2 x 10μF/25V ceramic capacitor (e.g. Murata GCM32ER71E106KA42)
- CO2 NA
- CTune 470pF ceramic capacitor (can be 1206, 0805 or 0603 size)
- RTune 150 ohms SMT resistor (can be 1206, 0805 or 0603 size)
- RTrim 6.19KΩ resistor

Mechanical Outline

Dimensions are in millimeters and (inches).

Tolerances: x.x mm ± 0.5 mm (x.xx in. ± 0.02 in.) [unless otherwise indicated]

x.xx mm ± 0.25 mm (x.xxx in ± 0.010 in.)

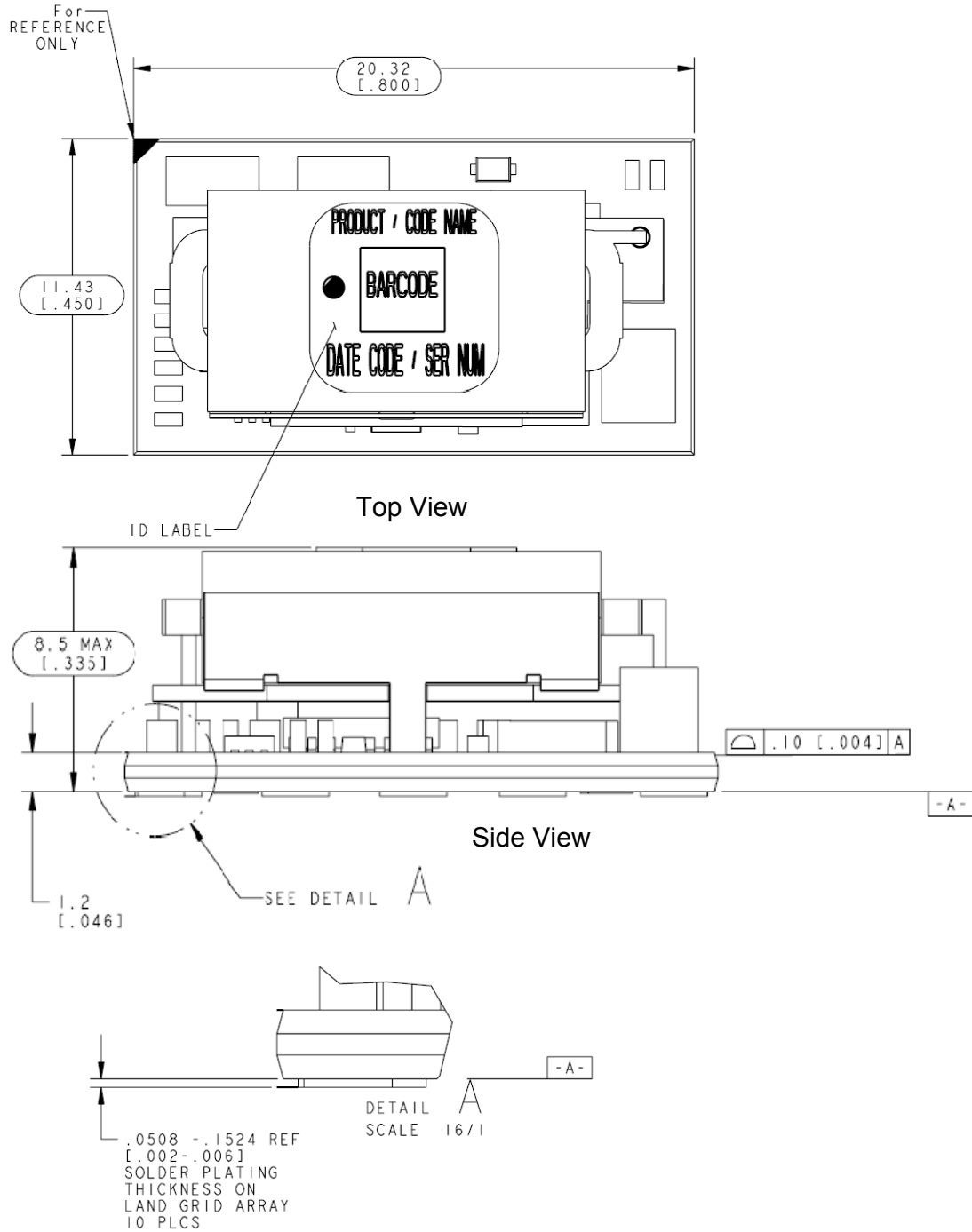

Recommended Pad Layout

Dimensions are in millimeters and (inches).

Tolerances: x.x mm ± 0.5 mm (x.xx in. ± 0.02 in.) [unless otherwise indicated]

x.xx mm ± 0.25 mm (x.xxx in ± 0.010 in.)

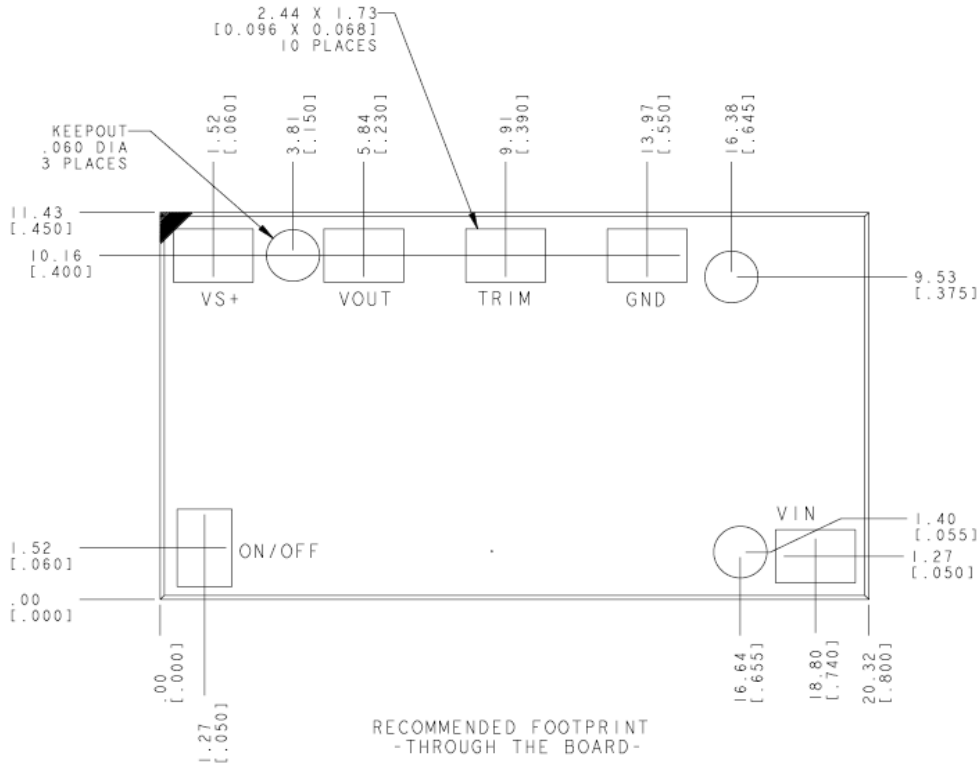

RECOMMENDED FOOTPRINT
 - THROUGH THE BOARD -

PIN	FUNCTION
1	ON/OFF
2	VIN
3	GND
4	TRIM
5	VOUT
6	VS+

Surface Mount Information

Pick and Place

The 9-36V ProLynx™ modules use an open frame construction and are designed for a fully automated assembly process. The modules are fitted with a label designed to provide a large surface area for pick and place operations. The label meets all the requirements for surface mount processing, as well as safety standards, and is able to withstand reflow temperatures of up to 300°C. The label also carries product information such as product code, serial number and the location of manufacture.

Nozzle Recommendations

The module weight has been kept to a minimum by using open frame construction. Variables such as nozzle size, tip style, vacuum pressure and placement speed should be considered to optimize this process. The minimum recommended inside nozzle diameter for reliable operation is 3mm. The maximum nozzle outer diameter, which will safely fit within the allowable component spacing, is 7 mm.

Lead Free Soldering

The 9-36V ProLynx™ modules are lead-free (Pb-free) and RoHS compliant and fully compatible in a Pb-free soldering process. Failure to observe the instructions below may result in the failure of or cause damage to the modules and can adversely affect long-term reliability.

Pb-free Reflow Profile

Power Systems will comply with J-STD-020 Rev. C (Moisture/Reflow Sensitivity Classification for Nonhermetic Solid State Surface Mount Devices) for both Pb-free solder profiles and MSL classification procedures. This standard provides a recommended forced-air-convection reflow profile based on the volume and thickness of the package (table 4-2). The suggested Pb-free solder paste is Sn/Ag/Cu (SAC). The recommended linear reflow profile using Sn/Ag/Cu solder is shown in Fig. 41. Soldering outside of the recommended profile requires testing to verify results and performance.

MSL Rating

The 9-36V ProLynx™ modules have a MSL rating of 2.

Storage and Handling

The recommended storage environment and handling procedures for moisture-sensitive surface mount packages is detailed in J-STD-033 Rev. A (Handling, Packing, Shipping and Use of Moisture/Reflow Sensitive Surface Mount Devices). Moisture barrier bags (MBB) with desiccant are required for MSL ratings of 2 or greater. These sealed packages should not be broken until time of use. Once the original

package is broken, the floor life of the product at conditions of $\leq 30^{\circ}\text{C}$ and 60% relative humidity varies according to the MSL rating (see J-STD-033A). The shelf life for dry packed SMT packages will be a minimum of 12 months from the bag seal date, when stored at the following conditions: $< 40^{\circ}\text{C}$, $< 90\%$ relative humidity.

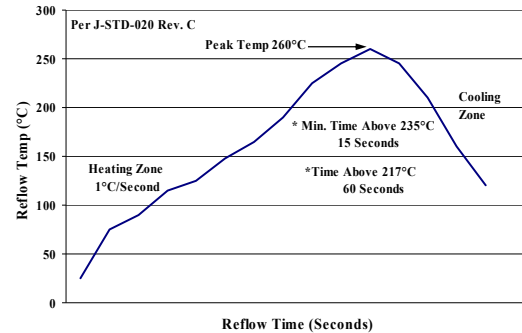

Figure 41. Recommended linear reflow profile using Sn/Ag/Cu solder.

Post Solder Cleaning and Drying Considerations

Post solder cleaning is usually the final circuit-board assembly process prior to electrical board testing. The result of inadequate cleaning and drying can affect both the reliability of a power module and the testability of the finished circuit-board assembly. For guidance on appropriate soldering, cleaning and drying procedures, refer to *Board Mounted Power Modules: Soldering and Cleaning Application Note (AN04-001)*.

Ordering Information

Please contact your Lineage Power Sales Representative for pricing, availability and optional features.

Table 5. Device Codes

Device Code	Input Voltage Range	Output Voltage	Output Current	On/Off Logic	Connector Type	Comcodes
APXW005A0X3-SRZ	9 – 36Vdc	3 – 18Vdc	5A – 2.5A	Negative	SMT	CC109151916
APXW005A0X43-SRZ				Positive	SMT	CC109151908

Table 6. Coding Scheme

TLynx family	Sequencing feature.	Input voltage range	Output current	Output voltage	On/Off logic	Remote Sense	Options	ROHS Compliance
AP	X	W	005	X	4	3	-SR	Z
	X = w/o Seq.	W = 9 - 36V	5A	X = programmable output	4 = positive No entry = negative	Available	S = Surface Mount R = Tape&Reel	Z = ROHS6



LINEAGE POWER®

World Wide Headquarters
Lineage Power Corporation
601 Shiloh Road, Plano, TX 75074, USA
+1-888-LINEAGE(546-3243)
(Outside U.S.A.: **+1-972-244-WATT(9288)**)
www.lineagepower.com
e-mail: techsupport1@lineagepower.com

Asia-Pacific Headquarters
Tel: +86.021.54279977*808

Europe, Middle-East and Africa Headquarters
Tel: +49.89.878067-280

India Headquarters
Tel: +91.80.28411633

Lineage Power reserves the right to make changes to the product(s) or information contained herein without notice. No liability is assumed as a result of their use or application. No rights under any patent accompany the sale of any such product(s) or information.

Lineage Power DC-DC products are protected under various patents. Information on these patents is available at www.lineagepower.com/patents.

© 2010 Lineage Power Corporation, (Plano, Texas) All International Rights Reserved.