

# THYRISTOR MODULE (NON-ISOLATED TYPE)

## PWB130A

PWB130A is a Thyristor module suitable for low voltage, 3 phase recifier applications.

- $I_{T(AV)}$ 130A (each device)
- high Surge Current 3500 A (50/60Hz)
- Easy Construction
- Non-isolated. Mounting base as common Anode terminal

### (Applications)

Welding power Supply  
Various DC power Supply

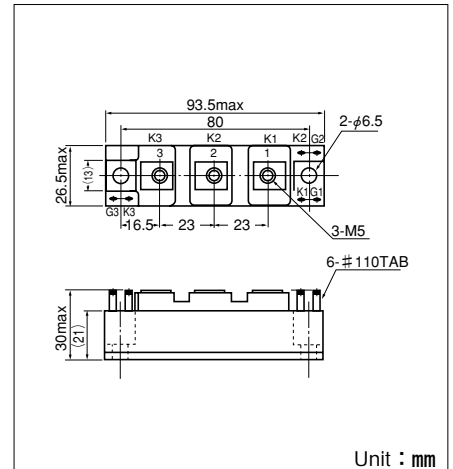
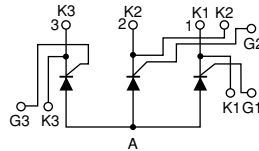

### Maximum Ratings

Symbol	Item	Ratings			Unit
		PWB130A20	PWB130A30	PWB130A40	
VRRM	Repetitive Peak Reverse Voltage	200	300	400	V
VRSM	Non-Repetitive Peak Reverse Voltage	240	360	480	V
VDRM	Repetitive Peak Off-State Voltage	200	300	400	V

Symbol	Item	Conditions	Ratings	Unit	
$I_{T(AV)}$	Average On-State Current	Single phase, half wave, 180° conduction, $T_c : 112^\circ\text{C}$	130	A	
$I_{T(RMS)}$	R.M.S. On-State Current	Single phase, half wave, 180° conduction, $T_c : 112^\circ\text{C}$	204	A	
$I_{TSM}$	Surge On-State Current	$\frac{1}{2}$ cycle, 50Hz/60Hz, peak value, non-repetitive	3200/3500	A	
$I^2t$	$I^2t$		51000	A <sup>2</sup> S	
$P_{GM}$	Peak Gate Power Dissipation		10	W	
$P_{G(AV)}$	Average Gate Power Dissipation		1	W	
$I_{FGM}$	Peak Gate Current		3	A	
$V_{FGM}$	Peak Gate Voltage (Forward)		10	V	
$V_{RGM}$	Peak Gate Voltage (Reverse)		5	V	
di/dt	Critical Rate of On-State Current	$I_G=200\text{mA}$ , $T_j=25^\circ\text{C}$ , $V_D=\frac{1}{2}V_{DRM}$ , $dI_G/dt=1\text{A}/\mu\text{s}$	50	A/ $\mu\text{s}$	
$T_j$	Operating Junction Temperature		-30 to +150	$^\circ\text{C}$	
$T_{stg}$	Storage Temperature		-30 to +125	$^\circ\text{C}$	
	Mounting torque	Mounting (M6)	Recommended 2.5-3.9 (25-40)	4.7 (48)	N·m (kgf·cm)
		Terminal (M5)	Recommended 1.5-2.5 (15-25)	2.7 (28)	
	Mass			170	g

### Electrical Characteristics

Symbol	Item	Conditions	Ratings			Unit
			Mix.	Typ.	Min.	
$I_{DRM}$	Repetitive Peak Off-State Current, max.	at $V_{DRM}$ , single phase, half wave, $T_j=150^\circ\text{C}$			30	mA
$I_{RRM}$	Repetitive Peak Reverse Current, max.	at $V_{DRM}$ , single phase, half wave, $T_j=150^\circ\text{C}$			30	mA
$V_{TM}$	Peak On-State Voltage, max.	On-State Current 410A, $T_j=150^\circ\text{C}$ Inst. measurement			1.2	V
$I_{GT}$	Gate Trigger Current, max.	$T_j=25^\circ\text{C}$ , $I_T=1\text{A}$ , $V_D=6\text{V}$			150	mA/V
$V_{GT}$	Gate Trigger Voltage, max.	$T_j=25^\circ\text{C}$ , $I_T=1\text{A}$ , $V_D=6\text{V}$			2	mA/V
$V_{GD}$	Non-Trigger Gate, Voltage. min.	$T_j=150^\circ\text{C}$ , $V_D=\frac{1}{2}V_{DRM}$	0.25			V
tgt	Turn On Time, max.	$I_T=100\text{A}$ , $I_G=200\text{mA}$ , $T_j=25^\circ\text{C}$ , $V_D=\frac{1}{2}V_{DRM}$ , $dI_G/dt=1\text{A}/\mu\text{s}$			10	$\mu\text{s}$
dv/dt	Critical Rate of Rise of Off-State Voltage, min.	$T_j=150^\circ\text{C}$ , $V_D=\frac{2}{3}V_{DRM}$ , Exponential wave.	50			V/ $\mu\text{s}$
$I_H$	Holding Current, typ.	$T_j=25^\circ\text{C}$			70	mA
$R_{th(j-c)}$	Thermal Impedance, max.	Junction to case ( $\frac{1}{3}$ Module)			0.2	$^\circ\text{C}/\text{W}$

### Gate Characteristics

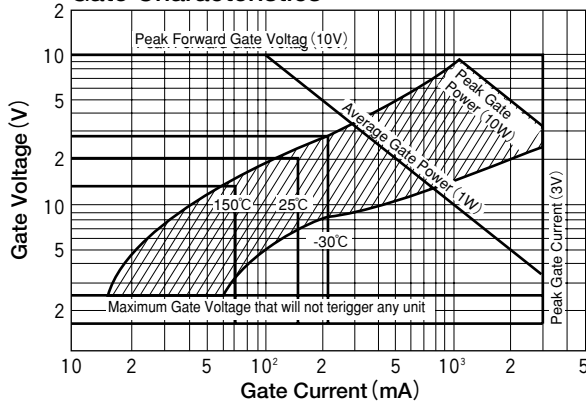

### On-State Voltage max

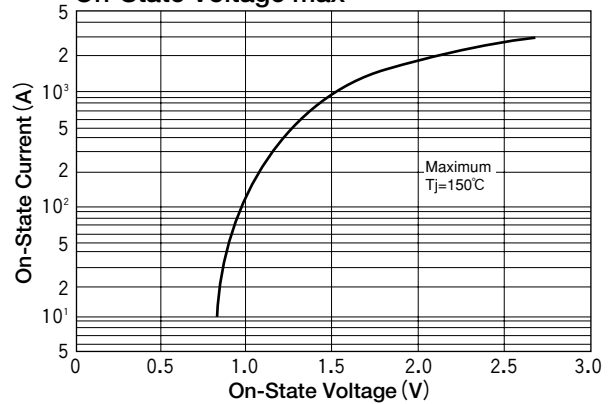

### Average On-State Current Vs Power Dissipation (Single phase half wave)

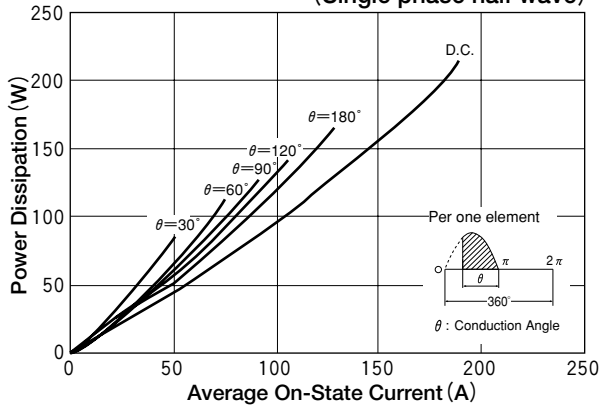

### Average On-State Current Vs Maximum Allowable Case Temperature (Single phase half wave)

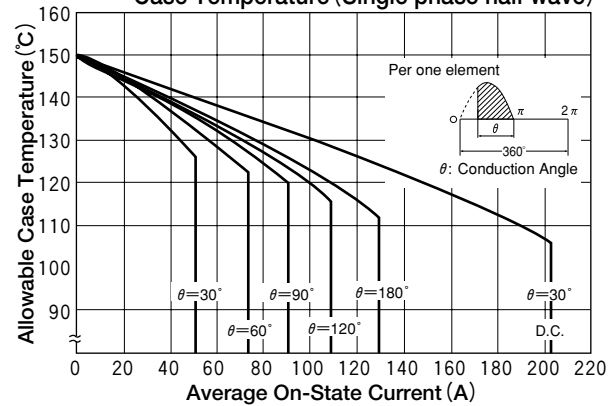

### Surge On-State Current Rating (Non-Repetitive)

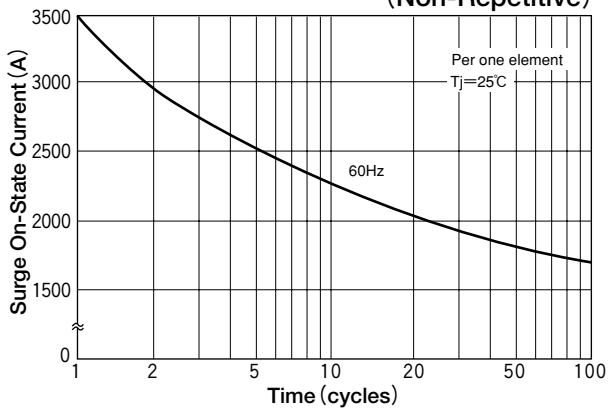

### Transient Thermal Impedance

