

PRODUCT SPECIFICATION

DATE:11/29/2012

cosmo ELECTRONICS CORPORATION	Photocoupler : KPC354NT	NO.61P04072	REV. 6
		SHEET 1 OF 6	

Mini-Flat package AC Input type Photocoupler

● Features

1. Halogen Free.
2. Pb free and RoHS compliant.
3. AC inputs
4. Mini-flat package:
compact 4 pin SOP with a 2.0mm profile
5. Subminiature type
(The volume is smaller than that of our conventional DIP type by as far as 30%)
6. Isolation voltage between input and output (Viso : 3750vrms).
7. Agency Approvals
 - UL approved : No.E169586
 - VDE approved : No.40014684
 - FIMKO approved : EN 60065 No. FI 23147 A1
EN 60950 No. FI 24583 A1
 - CQC approved : No. CQC04001010530

● Applications

1. Hybrid substrates that require high density mounting.
2. Programmable controllers.

PRODUCT SPECIFICATION

DATE:11/29/2012

cosmo ELECTRONICS CORPORATION	Photocoupler : KPC354NT	NO.61P04072	REV. 6
		SHEET 2 OF 6	

1. OUTSIDE DIMENSION : UNIT (mm)

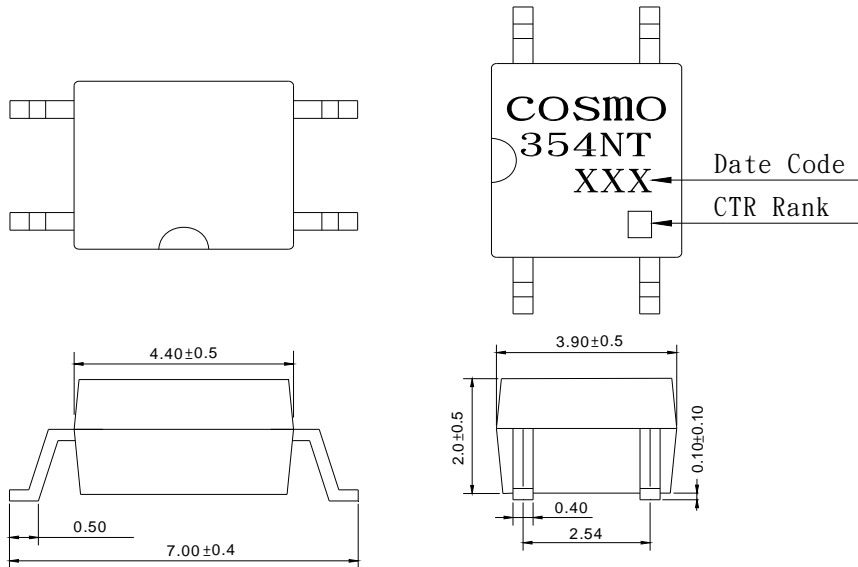

TOLERANCE : ±0.2mm

2. SCHEMATIC : TOP VIEW

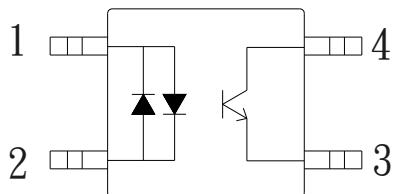

1. Anode, Cathode
2. Anode, Cathode
3. Emitter
4. Collector

PRODUCT SPECIFICATION

DATE:11/29/2012

cosmo ELECTRONICS CORPORATION	Photocoupler : KPC354NT	NO.61P04072	REV. 6
		SHEET 3 OF 6	

●Absolute Maximum Ratings

	Parameter	Symbol	Rating	Unit
Input	Forward current	I_F	± 50	mA
	Peak forward current	I_{FM}	± 1	A
	Power dissipation	P	70	mW
Output	Collector-emitter voltage	V_{CEO}	80	V
	Emitter-collector voltage	V_{ECO}	5	V
	Collector current	I_C	50	mA
	Collector power dissipation	P_C	150	mW
	Total power dissipation	P_{tot}	170	mW
	Isolation voltage 1 minute	V_{iso}	3750	Vrms
	Operating temperature	T_{opr}	-55 to +115	°C
	Storage temperature	T_{stg}	-55 to +125	°C
	Soldering temperature 10 second	T_{sol}	260	°C

●Electro-optical Characteristics

	Parameter	Symbol	Conditions	MIN.	TYP.	MAX.	Unit
Input	Forward voltage	V_F	$I_F = \pm 20\text{mA}$	-	1.2	1.4	V
	Terminal capacitance	C_t	$V = 0, f = 1\text{kHz}$	-	30	250	pF
Output	Collector dark current	I_{CEO}	$V_{CE} = 20\text{V}, I_F = 0$	-	-	0.1	uA
	Collector-emitter breakdown voltage	BV_{CEO}	$I_C = 0.1\text{mA}, I_F = 0$	80	-	-	V
	Emitter-collector breakdown voltage	BV_{ECO}	$I_F = 100\text{uA}, I_F = 0$	5	-	-	V
Transfer characteristics	Current transfer ratio	CTR	$I_F = \pm 1\text{mA}, V_{CE} = 5\text{V}$	20	-	400	%
	Collector-emitter saturation voltage	$V_{CE(sat)}$	$I_F = \pm 20\text{mA}, I_C = 1\text{mA}$	-	0.1	0.3	V
	Isolation resistance	R_{iso}	DC500V 40 to 60%RH	5×10^{10}	10^{11}	-	ohm
	Floating capacitance	C_f	$V = 0, f = 1\text{MHz}$	-	0.6	1.0	pF
	Response time (Rise)	t_r	$V_{ce} = 2\text{V}, I_C = 2\text{mA}, R_L = 100\text{ohm}$	-	4	18	us
	Response time (Fall)	t_f		-	3	18	us

●Classification table of current transfer ratio is shown below.

CTR RANK	CTR(%)
KPC354NT0A	50 TO 150
KPC354NT0B	20 TO 400

PRODUCT SPECIFICATION

DATE:11/29/2012

cosmo ELECTRONICS CORPORATION	Photocoupler :	NO.61P04072	REV. 6
	KPC354NT	SHEET 4 OF 6	

Fig.1 Forward Current vs.Ambient Temperature

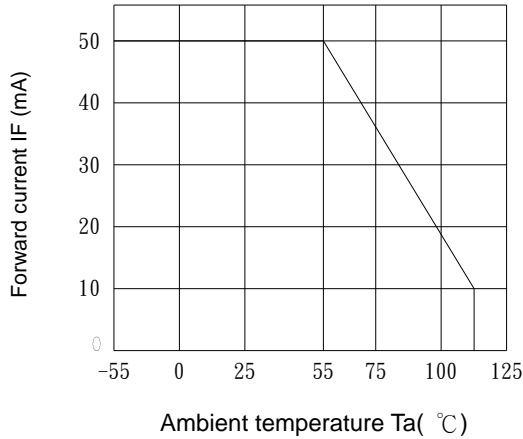

Fig.2 Diode Power Dissipation vs. Ambient Temperature

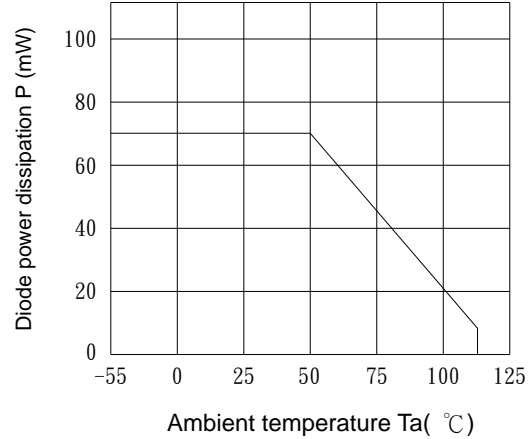

Fig.3 Collector Power Dissipation vs. Ambient Temperature

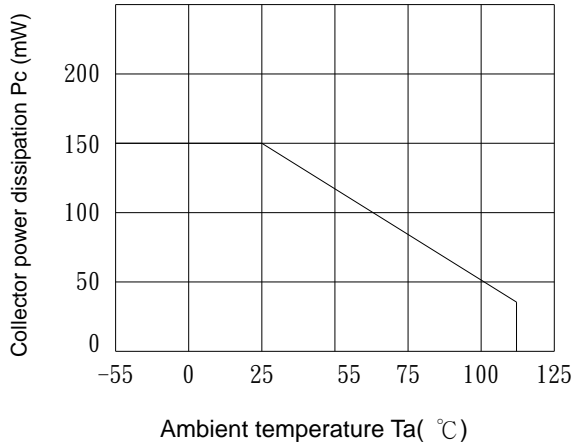

Fig.4 Total Power Dissipation vs. Ambient Temperature

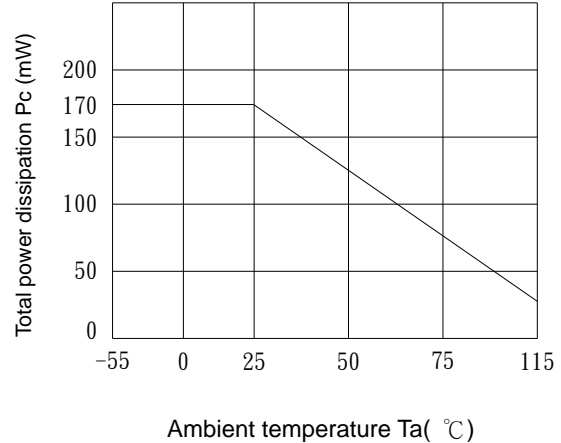

Fig.5 Peak Forward Current vs. Duty Ratio

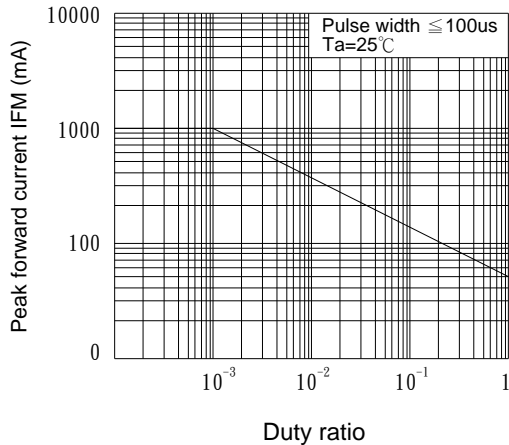
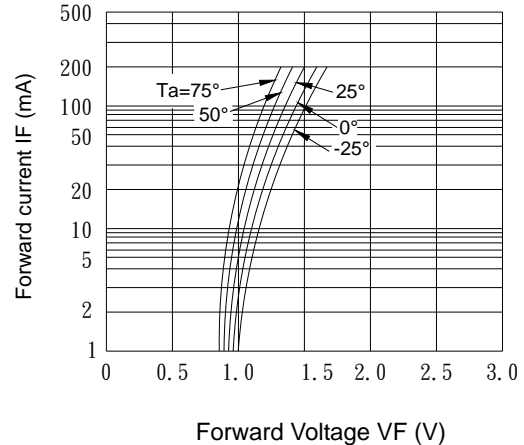

Fig.6 Forward Current vs. Forward Voltage



PRODUCT SPECIFICATION

DATE:11/29/2012

cosmo ELECTRONICS CORPORATION	Photocoupler :	NO.61P04072	REV. 6
	KPC354NT	SHEET 5 OF 6	

Fig.7 Current Transfer Ratio vs. Forward Current

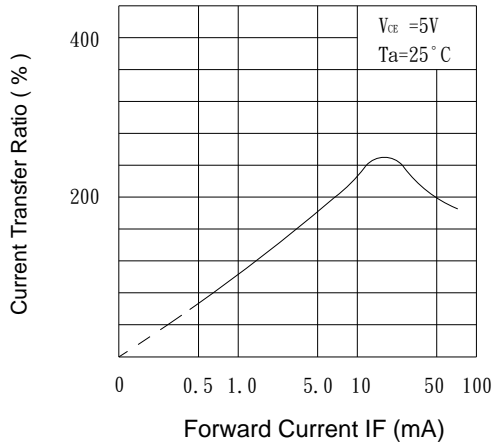

Fig.8 Collector Current vs. Collector-Emitter Voltage

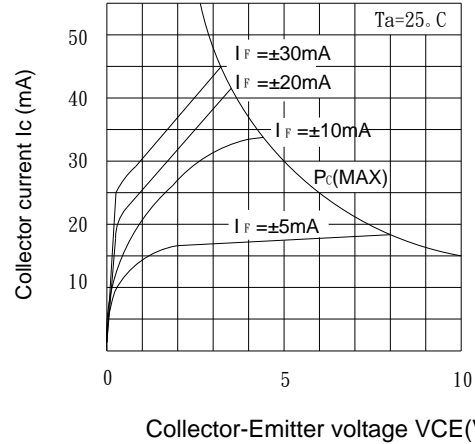

Fig.9 Relative Current Transfer Ratio vs. Ambient Temperature

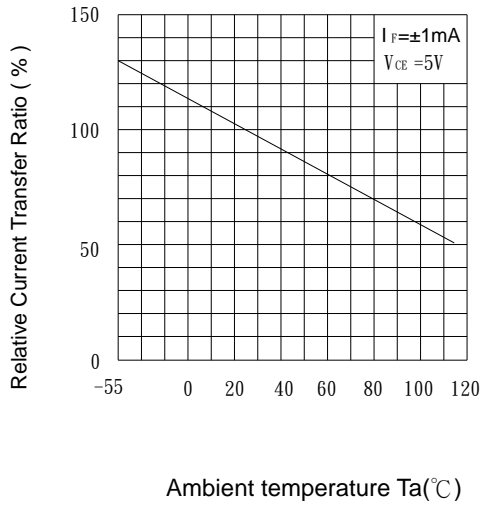

Fig.10 Collector-Emitter Saturation Voltage vs. Ambient Temperature

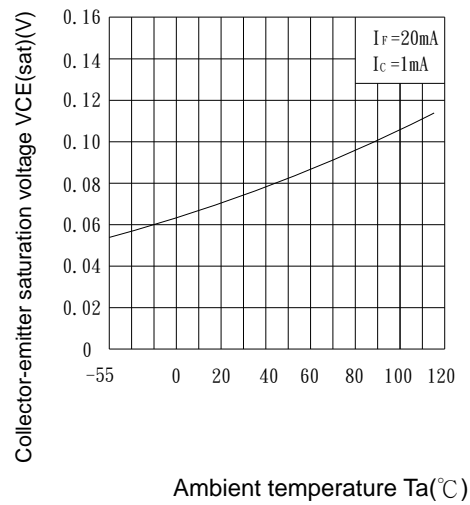

Fig.11 Collector Dark Current vs. Ambient Temperature

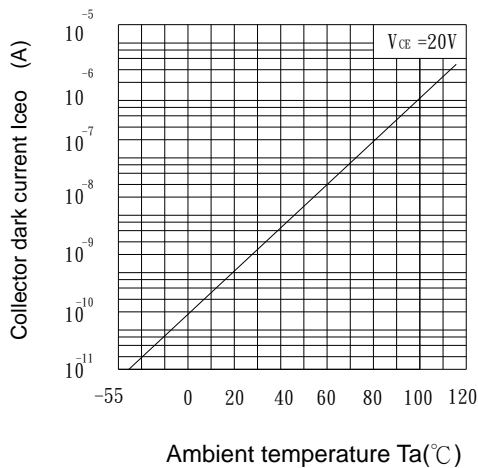
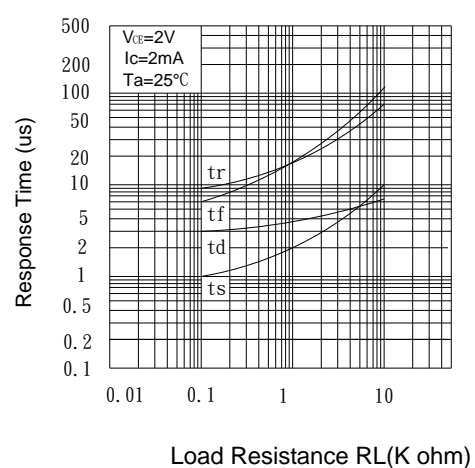

Fig.12 Response Time vs. Load Resistance



PRODUCT SPECIFICATION

DATE:11/29/2012

cosmo ELECTRONICS CORPORATION	Photocoupler : KPC354NT	NO.61P04072	REV.
		SHEET 6 OF 6	6

NOTICE

The information contained in this document is a general product description and is subject to change without notice. Please contact cosmo in order to obtain the latest device data sheets before using any cosmo device. cosmo does not assume any responsibility for use of any circuitry described. No circuit patent licenses are implied. This publication is the property of cosmo. No part of this publication may be reproduced or copied in any form or by any means, or transferred to any third party without the prior written consent of cosmo Electronics Corporation.

The devices listed in this document are designed for general applications only in electronic equipment. No devices shall be deployed which require higher level of reliability such as:

- Medical and other life support equipments.
- Space application.
- Telecommunication equipment (trunk lines).
- Nuclear power control equipment.

Unless it received prior written approval from cosmo.

cosmo takes no responsibility for damages arise form the improper usage of our device. Please contact cosmo for further information regarding the above notices.