

General Description

The AOD3N40 has been fabricated using an advanced high voltage MOSFET process that is designed to deliver high levels of performance and robustness in popular AC-DC applications.

By providing low $R_{DS(on)}$, C_{iss} and C_{rss} along with guaranteed avalanche capability this device can be adopted quickly into new and existing offline power supply designs.

Features

V_{DS}	500V@150°C
I_D (at $V_{GS}=10V$)	2.6A
$R_{DS(on)}$ (at $V_{GS}=10V$)	< 3.1Ω

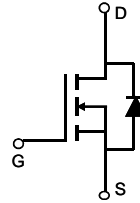

Absolute Maximum Ratings $T_A=25^\circ\text{C}$ unless otherwise noted

Parameter	Symbol	Maximum	Units
Drain-Source Voltage	V_{DS}	400	V
Gate-Source Voltage	V_{GS}	±30	V
Continuous Drain Current ^B	I_D	$T_C=25^\circ\text{C}$	2.6
		$T_C=100^\circ\text{C}$	1.6
Pulsed Drain Current ^C	I_{DM}	5.6	A
Avalanche Current ^C	I_{AR}	1.5	A
Repetitive avalanche energy ^C	E_{AR}	34	mJ
Single pulsed avalanche energy ^H	E_{AS}	68	mJ
Peak diode recovery dv/dt	dv/dt	5	V/ns
Power Dissipation ^B	P_D	$T_C=25^\circ\text{C}$	50
		Derate above 25°C	0.4
Junction and Storage Temperature Range	T_J, T_{STG}	-50 to 150	°C
Maximum lead temperature for soldering purpose, 1/8" from case for 5 seconds	T_L	300	°C

Thermal Characteristics

Parameter	Symbol	Typical	Maximum	Units
Maximum Junction-to-Ambient ^{A,G}	$R_{\theta JA}$	46	55	°C/W
Maximum Case-to-sink ^A	$R_{\theta CS}$	-	0.5	°C/W
Maximum Junction-to-Case ^{D,F}	$R_{\theta JC}$	2.1	2.5	°C/W

Electrical Characteristics (T_J=25°C unless otherwise noted)

Symbol	Parameter	Conditions	Min	Typ	Max	Units
STATIC PARAMETERS						
BV _{DSS}	Drain-Source Breakdown Voltage	I _D =250μA, V _{GS} =0V, T _J =25°C	400			V
		I _D =250μA, V _{GS} =0V, T _J =150°C		500		
BV _{DSS} /ΔT _J	Zero Gate Voltage Drain Current	I _D =250μA, V _{GS} =0V		0.4		V/°C
I _{DSS}	Zero Gate Voltage Drain Current	V _{DS} =400V, V _{GS} =0V			1	μA
		V _{DS} =320V, T _J =125°C			10	
I _{GSS}	Gate-Body leakage current	V _{DS} =0V, V _{GS} =±30V			±100	nA
V _{GS(th)}	Gate Threshold Voltage	V _{DS} =5V, I _D =250μA	3.4	4	4.5	V
R _{DS(ON)}	Static Drain-Source On-Resistance	V _{GS} =10V, I _D =1A		2.5	3.1	Ω
g _{FS}	Forward Transconductance	V _{DS} =40V, I _D =1A		1.7		S
V _{SD}	Diode Forward Voltage	I _S =1A, V _{GS} =0V		0.8	1	V
I _S	Maximum Body-Diode Continuous Current				2.6	A
I _{SM}	Maximum Body-Diode Pulsed Current				5.6	A
DYNAMIC PARAMETERS						
C _{iss}	Input Capacitance	V _{GS} =0V, V _{DS} =25V, f=1MHz	145	186	225	pF
C _{oss}	Output Capacitance		15	26	37	pF
C _{rss}	Reverse Transfer Capacitance		1.2	2.1	4.1	pF
R _g	Gate resistance	V _{GS} =0V, V _{DS} =0V, f=1MHz	2.2	4.4	6.6	Ω
SWITCHING PARAMETERS						
Q _g	Total Gate Charge	V _{GS} =10V, V _{DS} =320V, I _D =2.6A	3.3	4.2	5.1	nC
Q _{gs}	Gate Source Charge		1.2	1.7	2.1	nC
Q _{gd}	Gate Drain Charge		0.5	1.0	1.5	nC
t _{D(on)}	Turn-On DelayTime	V _{GS} =10V, V _{DS} =200V, I _D =2.6A, R _G =25Ω		14		ns
t _r	Turn-On Rise Time			10		ns
t _{D(off)}	Turn-Off DelayTime			18		ns
t _f	Turn-Off Fall Time			8		ns
t _{rr}	Body Diode Reverse Recovery Time		I _F =2.6A, di/dt=100A/μs, V _{DS} =100V	110	140	170
Q _{rr}	Body Diode Reverse Recovery Charge	I _F =2.6A, di/dt=100A/μs, V _{DS} =100V	0.5	0.64	0.8	μC

A. The value of R_{θJA} is measured with the device in a still air environment with T_A=25° C.

B. The power dissipation P_D is based on T_{J(MAX)}=150° C in a TO252 package, using junction-to-case thermal resistance, and is more useful in setting the upper dissipation limit for cases where additional heatsinking is used.

C. Repetitive rating, pulse width limited by junction temperature T_{J(MAX)}=150° C.

D. The R_{θJA} is the sum of the thermal impedance from junction to case R_{θJC} and case to ambient.

E. The static characteristics in Figures 1 to 6 are obtained using <300 μs pulses, duty cycle 0.5% max.

F. These curves are based on the junction-to-case thermal impedance which is measured with the device mounted to a large heatsink, assuming a maximum junction temperature of T_{J(MAX)}=150° C.

G. These tests are performed with the device mounted on 1 in² FR-4 board with 2oz. Copper, in a still air environment with T_A=25° C.

H. L=60mH, I_{AS}=1.5A, V_{DD}=150V, R_G=10Ω, Starting T_J=25° C

TYPICAL ELECTRICAL AND THERMAL CHARACTERISTICS

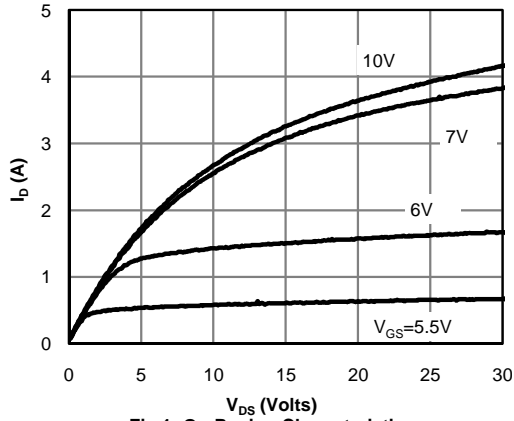

Figure 1: On-Region Characteristics

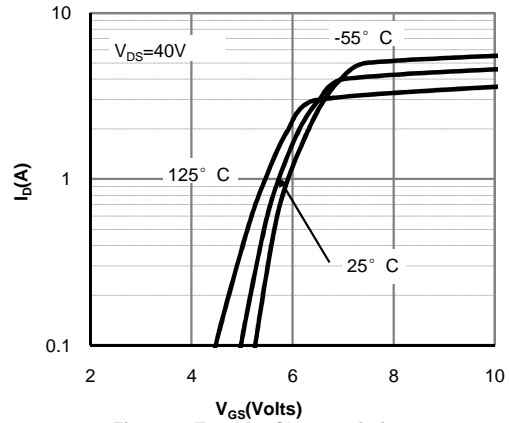

Figure 2: Transfer Characteristics

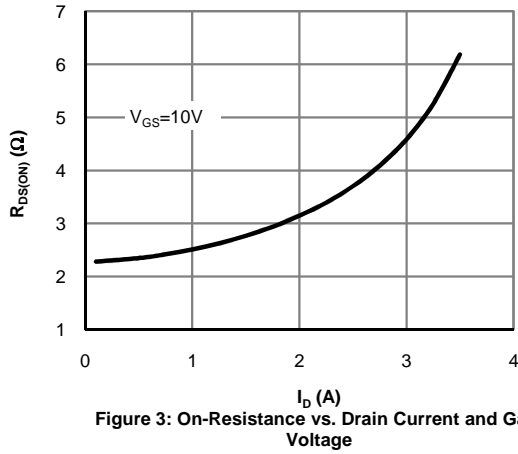

Figure 3: On-Resistance vs. Drain Current and Gate Voltage

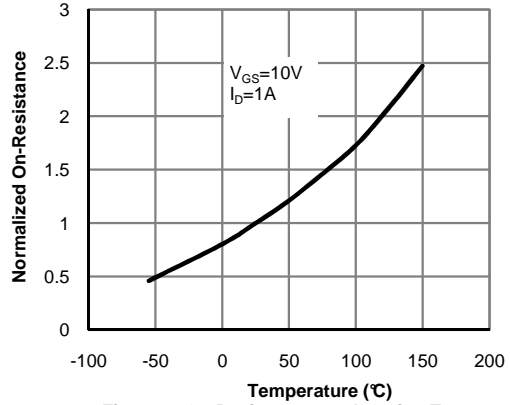

Figure 4: On-Resistance vs. Junction Temperature

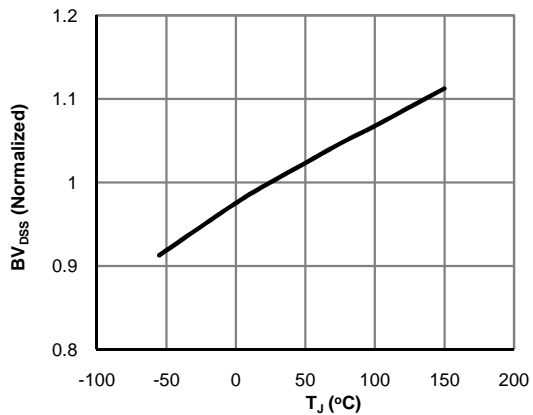

Figure 5: Break Down vs. Junction Temperature

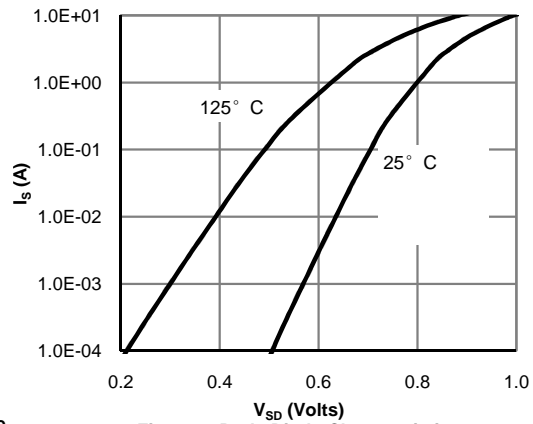

Figure 6: Body-Diode Characteristics

TYPICAL ELECTRICAL AND THERMAL CHARACTERISTICS

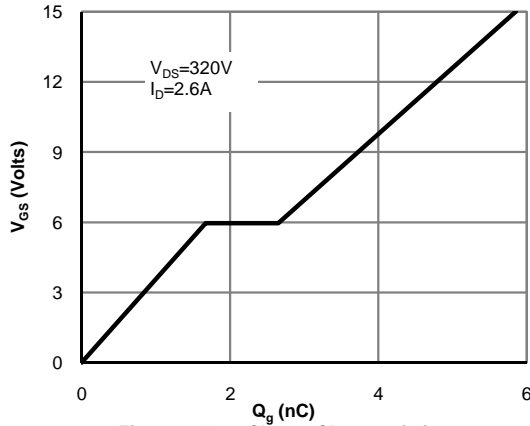

Figure 7: Gate-Charge Characteristics

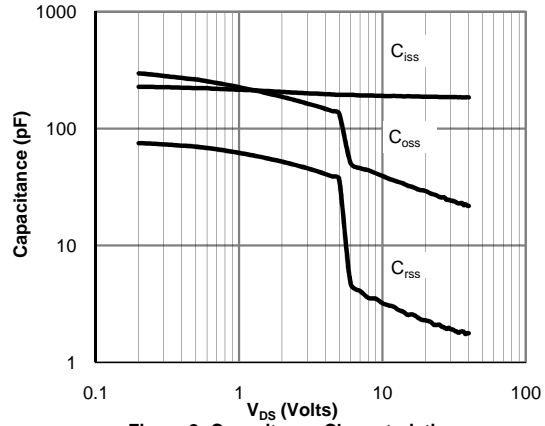

Figure 8: Capacitance Characteristics

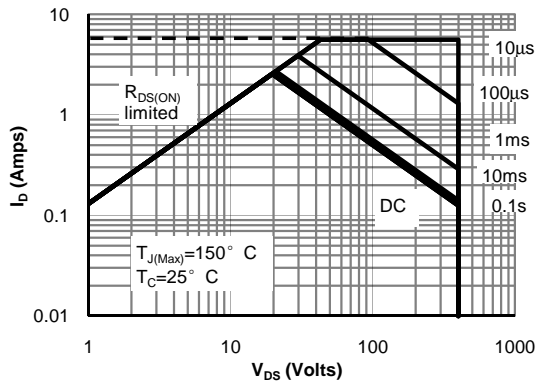

Figure 9: Maximum Forward Biased Safe Operating Area (Note F)

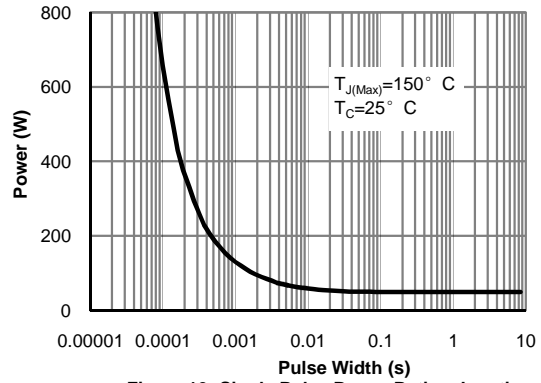

Figure 10: Single Pulse Power Rating Junction-to-Case (Note F)

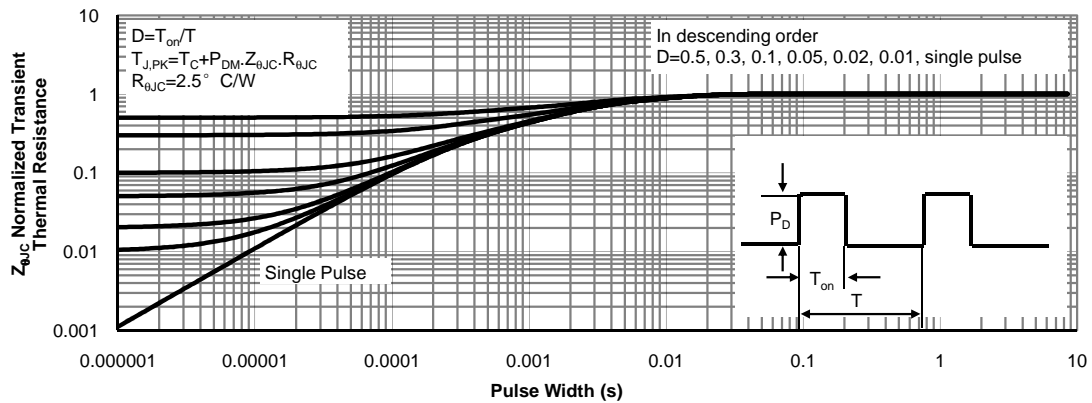

Figure 11: Normalized Maximum Transient Thermal Impedance (Note F)

TYPICAL ELECTRICAL AND THERMAL CHARACTERISTICS

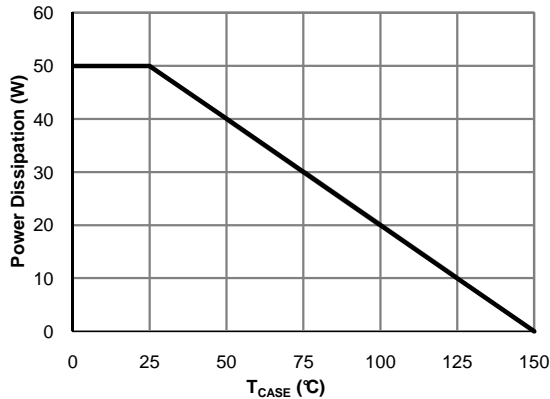

Figure 12: Power De-rating (Note B)

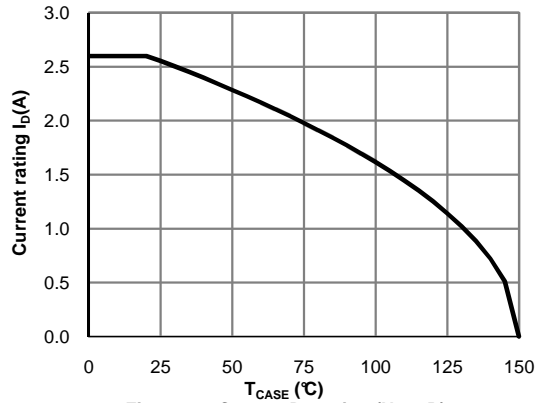

Figure 13: Current De-rating (Note B)

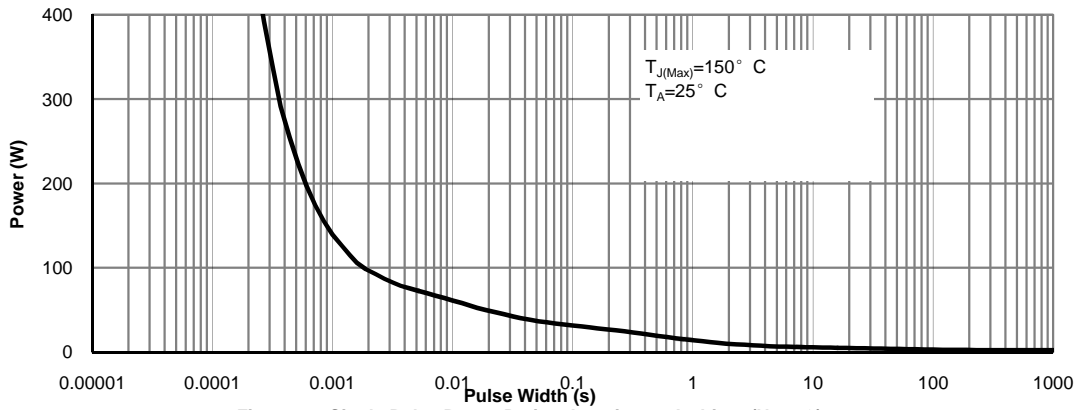

Figure 14: Single Pulse Power Rating Junction-to-Ambient (Note G)

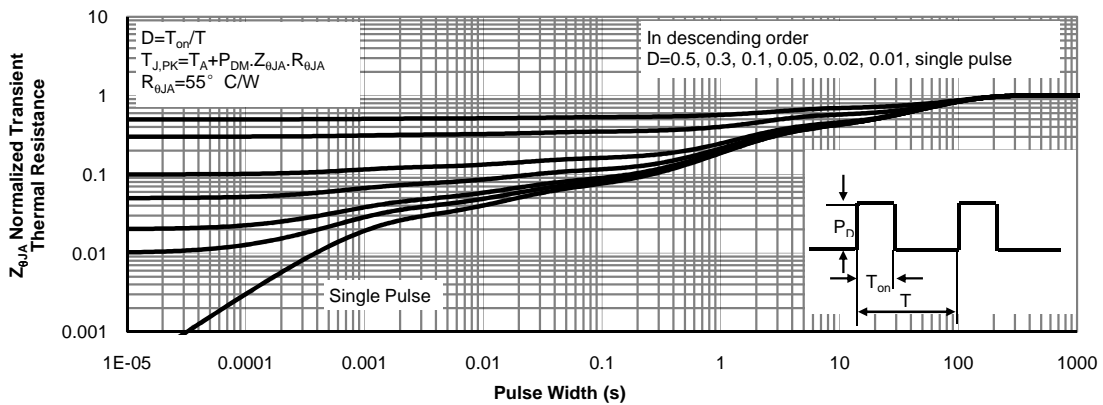
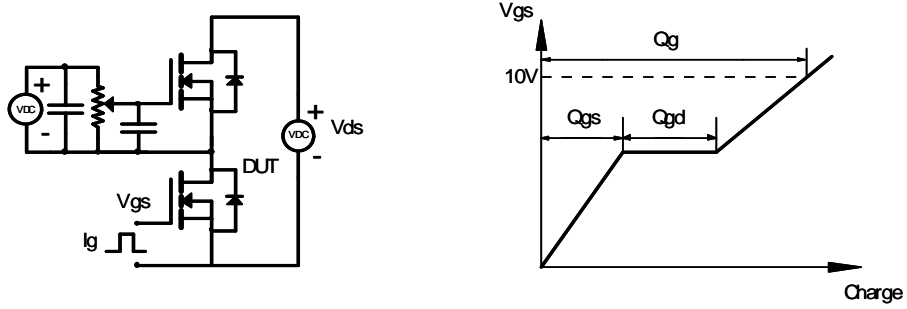
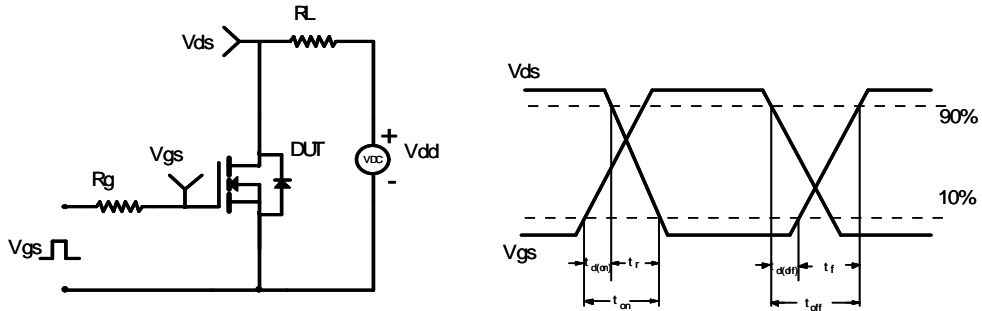

Figure 15: Normalized Maximum Transient Thermal Impedance (Note G)

Gate Charge Test Circuit & Waveform



Resistive Switching Test Circuit & Waveforms



Unclamped Inductive Switching (UIS) Test Circuit & Waveforms

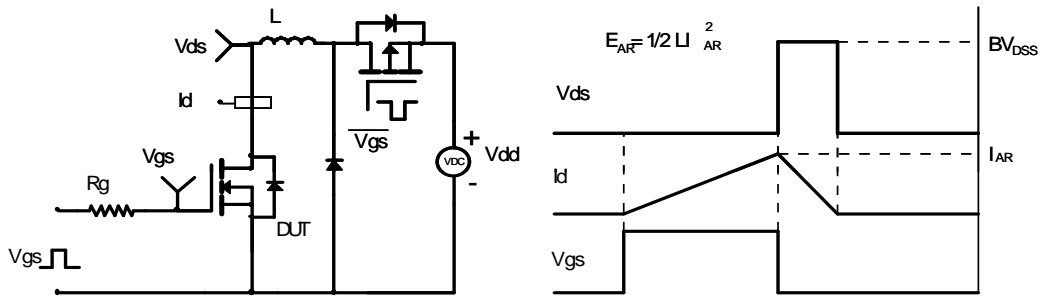

Diode Recovery Test Circuit & Waveforms

