

# LCD MODULE SPECIFICATION

**Products Name: APAX T13A4  
33.8CM(13.3 INCH) XGA(1024x768)  
262K COLOR TFT LCD MODULE  
3.3V**

- **Preliminary Specification**

**This technical specification is tentative and it will be changed without notice.**

進金生實業股份有限公司

台北市內湖區瑞光路76巷39號4樓

Tel:02-87912868 Fax:02-87912869

Version. 1.0

# **i Contents**

i Contents

ii Record of Revision

## **1.0 Handling Precautions**

## **2.0 General Description**

2.1 Characteristics

2.2 Functional Block Diagram

## **3.0 Absolute Maximum Ratings**

## **4.0 Optical Characteristics**

## **5.0 Signal Interface**

5.1 Connectors

5.2 Signal Pin

5.3 Signal Description

5.4 Signal Electrical Characteristics

5.5 Signal for Lamp connector

## **6.0 Pixel format image**

## **7.0 Parameter guide line for CFL Inverter**

## **8.0 Interface Timings**

8.1 Timing Characteristics

8.2 Timing Definition

## **9.0 Power Consumption**

## **10.0 Power ON/OFF Sequence**

## **11.0 Environment**

11.1 Temperature and humidity

11.1.1 Operating conditions

11.1.2 Shipping conditions

11.2 Atmospheric pressure

11.3 Thermal shock

## **12.0 Reliability**

12.1 Failure criteria

12.2 Failure rate

12.2.1 Usage

12.2.2 Components de-rating

12.3 CCFL life

12.4 ON/OFF cycle

## **13.0 Safety**

13.1 Sharp edge requirement

13.2 Material

13.2.1 Toxicity

13.2.2 Flammability

13.3 Capacitors

13.4 Hazardous voltage

## **1 4.0 Mechanical Characteristics**

## ii Record of Revision

Version and Date	Page	Description
1. '99/7/9	All	First Edition for Customer
2. '99/8/12	4	Revise weight spec : 480g max. -> 490g typ.
3. '99/8/16	4	Revise Avg. White Luminance 150 cd/m <sup>2</sup> -> 120 cd/m <sup>2</sup> (Note 1)
	7	Revise Viewing Angle Spec
	14	Revise Avg. White Luminance 150 cd/m <sup>2</sup> -> 120 cd/m <sup>2</sup> (D.P.-1)
4. '99/10/21	4	Revise Avg. White Luminance 120 cd/m <sup>2</sup> -> 145 cd/m <sup>2</sup>
	4	Add Luminance Uniformity Spec
	8	Add Contrast Ratio Min. Value
	8	Add Color Chromaticity Spec
	8	Revise Avg. White Luminance Min. and Typ. Value
	15	Revise Avg. White Luminance Min. and D.P.-1 Value

### 1.0 Handling Precautions

- 1) Since front polarizer is easily damaged, pay attention not to scratch it.
- 2) Be sure to turn off power supply when inserting or disconnecting from input connector.
- 3) Wipe off water drop immediately. Long contact with water may cause discoloration or spots.
- 4) When the panel surface is soiled, wipe it with absorbent cotton or other soft cloth.
- 5) Since the panel is made of glass, it may break or crack if dropped or bumped on hard surface.
- 6) Since CMOS LSI is used in this module, take care of static electricity and insure human earth when handling.
- 7) Do not open nor modify the Module Assembly.
- 8) Do not press the reflector sheet at the back of the module to any directions.
- 9) In case if a Module has to be put back into the packing container slot after once it was taken out from the container, do not press the center of the CFL Reflector edge.  
Instead, press at the far ends of the CFL Reflector edge softly. Otherwise the TFT Module may be damaged.
- 10) At the insertion or removal of the Signal Interface Connector, be sure not to rotate nor tilt the Interface Connector of the TFT Module.
- 11) After installation of the TFT Module into an enclosure ( Notebook PC Bezel, for example), do not twist nor bent the TFT Module even momentary. At designing the enclosure, it should be taken into consideration that no bending/twisting forces are applied to the TFT Module from outside. Otherwise the TFT Module may be damaged.

## 2.0 General Description

This specification applies to the 13.3 inch Color TFT/LCD Module .

This module is designed for a display unit of notebook style personal computer.

The screen format is intended to support the XGA (1024(H) x 768(V)) screen and 262,144 colors (RGB 6-bit data driver ).

All input signals are LVDS interface compatible.

This module does not contain an inverter card for backlight.

## 2.1 Characteristics

The following items are characteristics summary on the table under 25 °C condition:

ITEMS	SPECIFICATIONS
Screen Diagonal [mm]	338(13.3")
Active Area [mm]	270.336(H) x 202.752(V)
Pixels H x V	1024(x3) x 768
Pixel Pitch [mm]	0.264(per one triad) x 0.264
Pixel Arrangement	R.G.B. Vertical Stripe
Display Mode	Normally White
Average White Luminance [cd/m <sup>2</sup> ]	145 @ 6.0 mA (Note : 1)
Luminance Uniformity	1.25 max. (5 points) 1.65 max. (13 points) (Note : 2)
Contrast Ratio	200 : 1 Typ.
Optical Rise Time/Fall Time [msec]	30 Typ., 50 Max.
Nominal Input Voltage [Volt]	
VDD	+3.3 V
Typical Power Consumption [watt] (VDD line + VCFL line)	5.0(w/o Inverter, All Black Pattern)
Weight [grams]	490 typ.
Physical Size [mm]	284(W) x 214.3(H) x 6.1(D) typ., 6.4(D) max.
Electrical Interface	R/G/B Data, 3 Sync. Signals, Clock (4 pairs LVDS)
Support Color	Native 262,144 colors ( RGB 6-bit data driver )
Temperature Range (°C)	
Operating	0 to +50
Storage (Shipping)	-20 to +60

Note 1 : Definition of Average White Luminance

256                      Center                      768

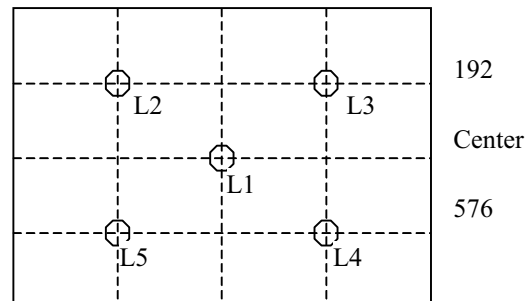

$$\text{Average White Luminance} = (L1+L2+L3+L4+L5)/5$$

Note : 2 Definition of Luminance Uniformity

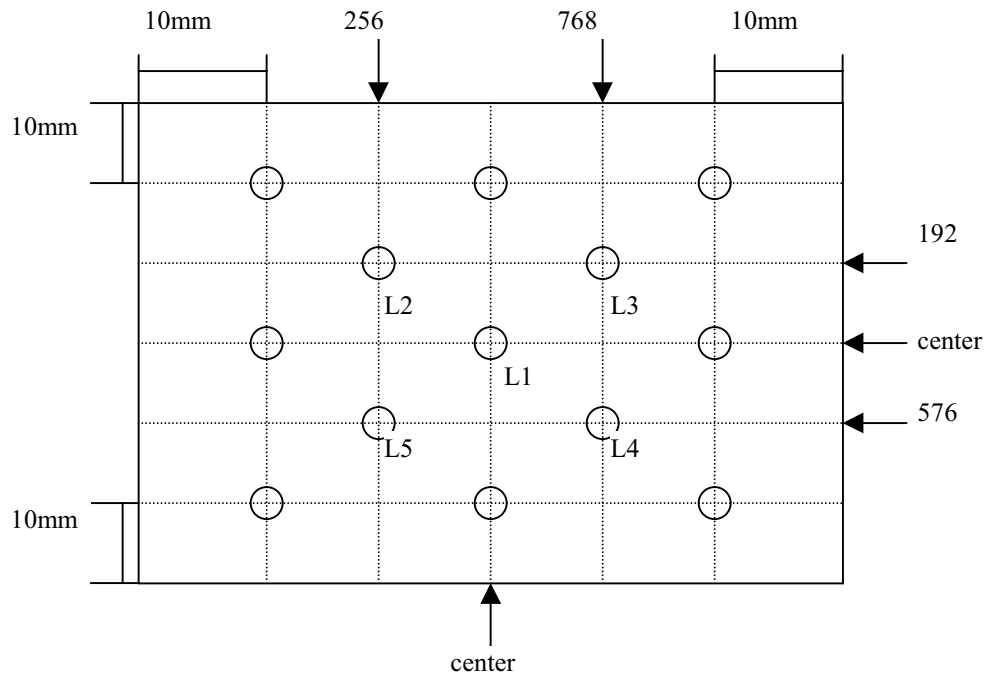

Luminance Uniformity (5 points) = Max. of (L1,L2,L3,L4,L5) / Min. of (L1,L2,L3,L4,L5)

Luminance Uniformity (13 points) = Max. of the brightness of 13 points / Min. of the brightness of 13 points

2.2 Functional Block Diagram

The following diagram shows the functional block of the 13.3 inches Color TFT/LCD Module:

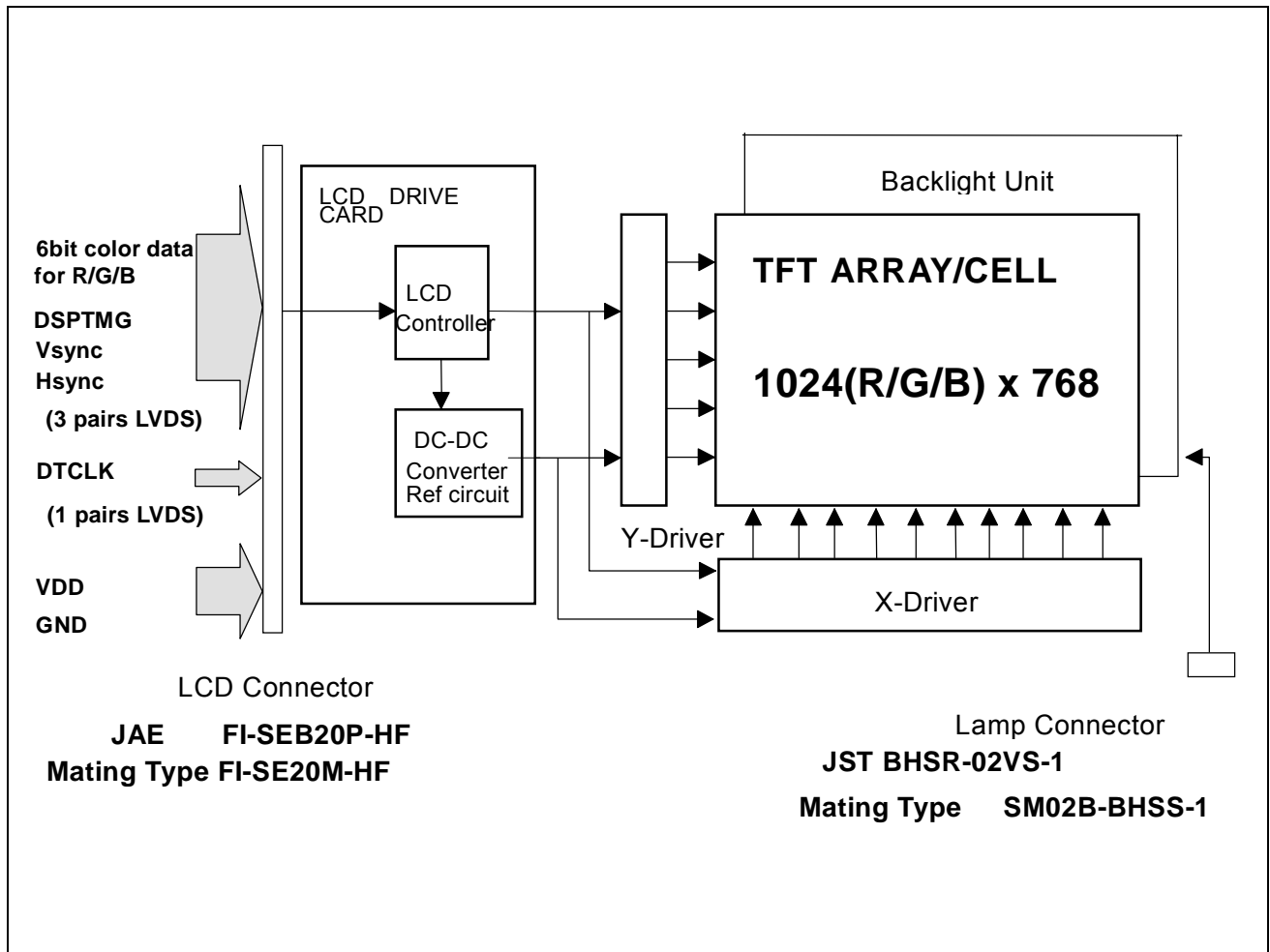

### 3.0 Absolute Maximum Ratings

Absolute maximum ratings of the module is as follows :

Item	Symbol	Min	Max	Unit	Conditions
Logic/LCD Drive Voltage	VDD	V <sub>ss</sub> -0.3	+4.0	V	
CFL Inrush current	ICFLL		20	mA	Note 2
CFL Current	ICFL	2.0	7.5	mA rms	
Operating Temperature	TOP	0	+50	°C	Note 1
Operating Humidity	HOP	8	95	%RH	Note 1
Storage Temperature	TST	-20	+60	°C	Note 1
Storage Humidity	HST	8	95	%RH	Note 1

**Note 1 : Maximum Wet-Bulb should be 39°C and No condensation.**

**Note 2 : Duration=50 msec.**

## 4.0 Optical Characteristics

The optical characteristics are measured under stable conditions as follows under 25°C condition:

Item	Conditions	Min.	Typ.	Max.
Viewing Angle (Degrees)	Horizontal (Right)	40	--	--
	K $\leq$ 10 (Left)	40	--	--
K: Contrast Ratio	Vertical (Upper)	10	--	--
	K $\leq$ 10 (Lower)	30	--	--
Contrast ratio		100	200	
Response Time (ms)	Rising		30	50
	Falling		30	50
Color Chromaticity (CIE)	Red x	0.537	0.577	0.617
	Red y	0.308	0.338	0.368
	Green x	0.280	0.310	0.340
	Green y	0.524	0.554	0.584
	Blue x	0.128	0.158	0.188
	Blue y	0.084	0.124	0.164
	White x	0.283	0.313	0.343
	White y	0.299	0.329	0.359
Average White Luminance(cd/m <sup>2</sup> )		115	145	



## 5.0 Signal Interface

### 5.1 Connectors

Physical interface is described as for the connector on module.

These connectors are capable of accommodating the following signals and will be following components.

Connector Name / Designation	For Signal Connector
Manufacturer	JAE
Type / Part Number	FI-SEB20P-HF
Mating Housing/Part Number	FI-SE20M-HF

Connector Name / Designation	For Lamp Connector
Manufacturer	JST
Type / Part Number	BHSR-02VS-1
Mating Type / Part Number	SM02B-BHSS-1

### 5.2 Signal Pin

Pin#	Signal Name	Pin#	Signal Name
1	VDD	2	VDD
3	GND	4	GND
5	Rxin0-	6	Rxin0+
7	GND	8	Rxin1-
9	Rxin1+	10	GND
11	Rxin2-	12	Rxin2+
13	GND	14	Rxclk-
15	Rxclk+	16	GND
17	NC	18	Reserved
19	GND	20	GND

### 5.3 Signal Description

The module using a LVDS receiver SN75LVDS86DGG(Texas Instruments) or compatible. LVDS is a differential signal technology for LCD interface and high speed data transfer device. Transmitter shall be SN75LVDS84DGG(negative edge sampling) or compatible.

PIN#	SIGNAL NAME	Description
1	VDD	+3.3V Power Supply
2	VDD	+3.3V Power Supply
3	GND	Ground
4	GND	Ground
5	Rxin0-	Negative LVDS differential data input (R0-R5, G0)
6	Rxin0+	Positive LVDS differential data input (R0-R5, G0)
7	GND	Ground
8	Rxin1-	Negative LVDS differential data input (G1-G5, B0-B1)
9	Rxin1+	Positive LVDS differential data input (G1-G5, B0-B1)
10	GND	Ground
11	Rxin2-	Negative LVDS differential data input (B2-B5, HSYNC, VSYNC, DSPTMG)
12	Rxin2+	Positive LVDS differential data input (B2-B5, HSYNC, VSYNC, DSPTMG)
13	GND	Ground
14	Rxclk-	Negative LVDS differential clock input
15	Rxclk+	Positive LVDS differential clock input
16	GND	Ground
17	NC	Reserved for future use
18	Reserved	Reserved for LVDS MFG Test
19	GND	Ground
20	GND	Ground

Internal circuits of LVDS inputs are as follows.

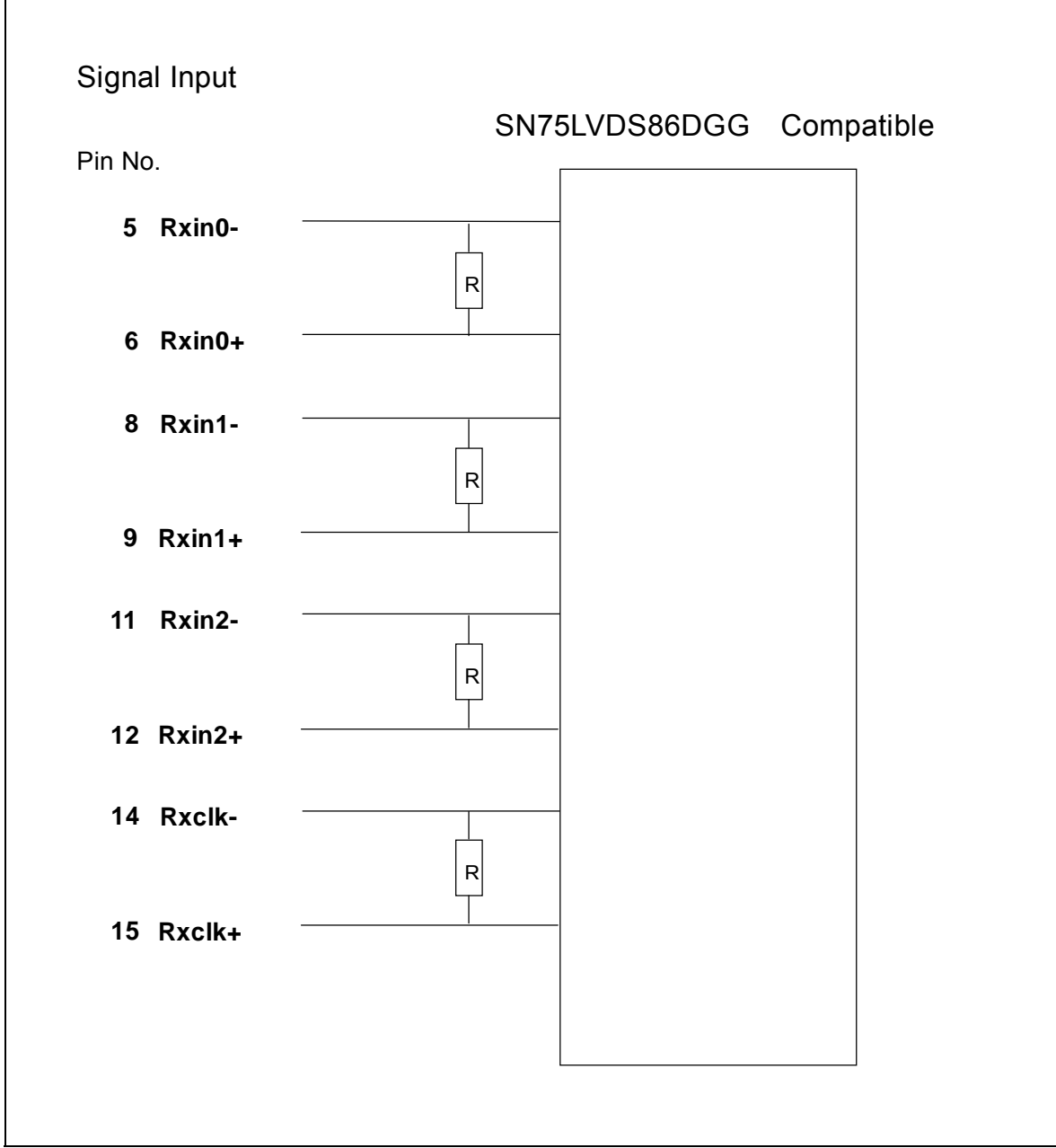

The module uses a 100 ohm resistor between positive and negative data lines of each receiver input.

<b>SIGNAL NAME</b>	<b>Description</b>	
+RED5 +RED4 +RED3 +RED2 +RED1 +RED0	Red Data 5 (MSB) Red Data 4 Red Data 3 Red Data 2 Red Data 1 Red Data 0 (LSB)  <b>Red-pixel Data</b>	Each red pixel's brightness data consists of these 6 bits pixel data.
+GREEN 5 +GREEN 4 +GREEN 3 +GREEN 2 +GREEN 1 +GREEN 0	Green Data 5 (MSB) Green Data 4 Green Data 3 Green Data 2 Green Data 1 Green Data 0 (LSB)  <b>Green-pixel Data</b>	Each green pixel's brightness data consists of these 6 bits pixel data.
+BLUE 5 +BLUE 4 +BLUE 3 +BLUE 2 +BLUE 1 +BLUE 0	Blue Data 5 (MSB) Blue Data 4 Blue Data 3 Blue Data 2 Blue Data 1 Blue Data 0 (LSB)  <b>Blue-pixel Data</b>	Each blue pixel's brightness data consists of these 6 bits pixel data.
-DTCLK	<b>Data Clock</b>	The typical frequency is 65.0 MHz. The signal is used to strobe the pixel data and DSPTMG signals. All pixel data shall be valid at the falling edge when the DSPTMG signal is high.
DSPTMG	<b>Display Timing</b>	This signal is strobed at the falling edge of -DTCLK. When the signal is high, the pixel data shall be valid to be displayed.
VSYNC	<b>Vertical Sync</b>	The signal is synchronized to -DTCLK .
HSYNC	<b>Horizontal Sync</b>	The signal is synchronized to -DTCLK .

**Note:** Output signals from any system shall be low or Hi-Z state when VDD is off.

## 5.4 Signal Electrical Characteristics

Each signal characteristics are as follows;

Parameter	Condition	Min	Max	UNITS
Vth	Differential Input High Voltage(Vcm=+1.2V)		100	mV
Vtl	Differential Input Low Voltage(Vcm=+1.2V)	-100		mV

(\*) It is recommended to refer the specifications of SN75LVDS86DGG (Texas Instruments) in detail.

## 5.5 Signal for Lamp connector

Pin #	Signal Name
1	Lamp High Voltage
2	Lamp Low Voltage

## 6.0 Pixel format image

Following figure shows the relationship of the input signals and LCD pixel format.

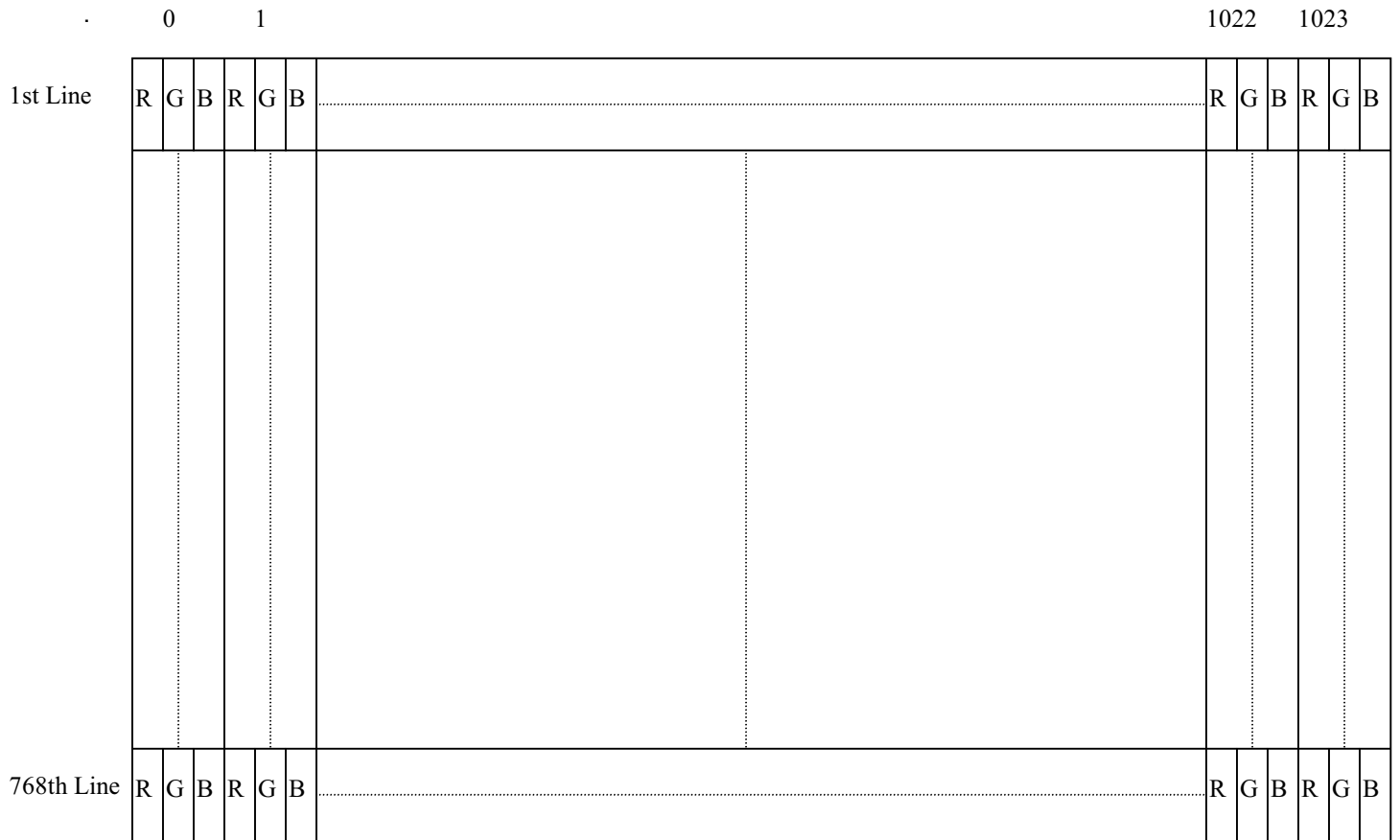

## 7.0 Parameter guide line for CFL Inverter

SYMBOL	PARAMETER	MIN	D.P-1 Note1	MAX	UNITS	CONDITION
	Avg. White Luminance	115	145	-	cd/m <sup>2</sup>	(Ta=25°C)
ICFL	CFL current	2.0	6.0	7.5	mA rms	(Ta=25°C)
ICFLL	CFL Inrush current	-	-	20	mA	<b>Note 2</b>
fCFL	CFL Frequency	40	50	60	KHz	(Ta=25°C) <b>Note 3</b>
ViCFL	CFL Ignition Voltage			1220	V rms	(Ta= 0°C) <b>Note 5</b>
VCFL	CFL Discharge Voltage (Reference)		601		V rms	(Ta=25°C) <b>Note 4</b>
PCFL	CFL Power consumption		3.6		W	(Ta=25°C) <b>Note 4</b>

Note 1: Design Point-1 ; At Avg. White Luminance 145cd/m<sup>2</sup>, PCFL=3.6W is required.

Note 2: ( duration=50 (msec) )

Note 3: CFL Frequency should be carefully determined to avoid interference between inverter and TFT LCD

Note 4: Calculator value for reference (ICFL×VCFL=PCFL)

Note 5: CFL inverter should be able to give out a power that has a generating capacity of over 1220 voltage.  
Lamp units need 1220 voltage minimum for ignition.

## 8.0 Interface Timings

Basically, interface timings described here is not actual input timing of LCD module but output timing of SN75LVDS86DGG (Texas Instruments) or equivalent.

### 8.1 Timing Characteristics

Symbol		MIN	TYP	MAX	Unit
fdck	DTCLK Frequency		65.00		MHz
tck	DTCLK cycle time		15.38		nsec
tx	X total time	1206	1344	2047	tck
tacx	X active time	129	1024		tck
tbkx	X blank time	90	320		tck
Hsync	H frequency		48.363		KHz
Hsw	H-Sync width	2	136		tck
Hbp	H back porch	1	160		tck
Hfp	H front porch	0	24		tck
ty	Y total time	771	806	1023	tx
tacy	Y active time		768		tx
Vsync	Frame rate	(55)	60	61	Hz
Vw	V-sync Width	1	6		tx
Vfp	V-sync front porch	1	3		tx
Vbp	V-sync back porch	7	29	63	tx

**Note:** Hsw(H-sync width) + Hbp(H-sync back porch) should be less than 515 tck.



## 8.2 Timing Definition

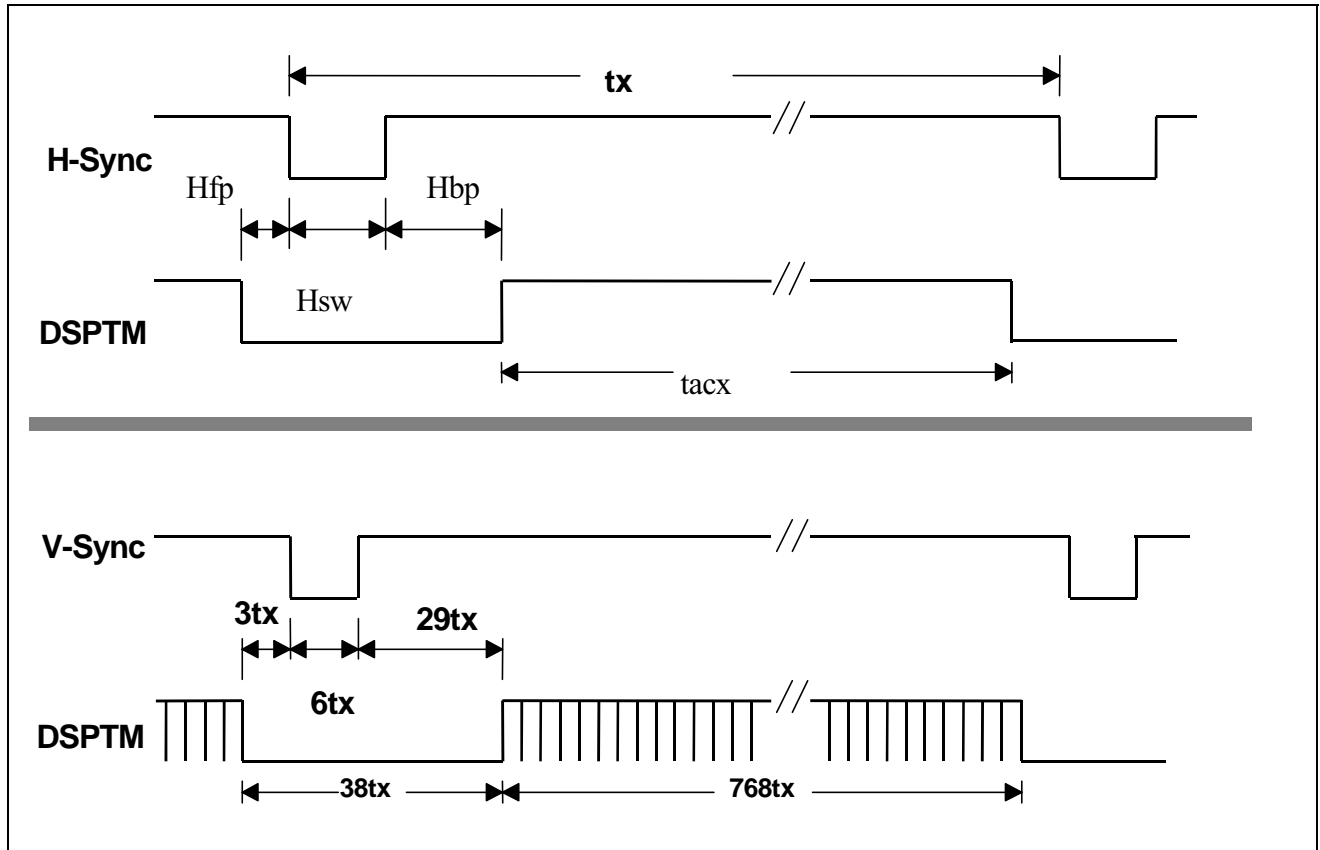

## 9.0 Power Consumption

Input power specifications are as follows;

<b>SYMBOL</b>	<b>PARAMETER</b>	<b>Min</b>	<b>Typ</b>	<b>Max</b>	<b>UNITS</b>	<b>CONDITION</b>
VDD	Logic/LCD Drive Voltage	3.0	3.3	3.6	V	Load Capacitance 100uF typ
PDD	VDD Power		1.2	1.3	W	All Black Pattern
PDDmax	VDD Power max			1.60	W	Sub-pixel checker
VDDrp	Allowable Logic/LCD Drive Ripple Voltage			100	mVp-p	
VDDns	Allowable Logic/LCD Drive Ripple Noise			100	mVp-p	

# 10.0 Power ON/OFF Sequence

VDD power and lamp on/off sequence is as follows. Interface signals are also shown in the chart. Signals from any system shall be Hi-Z state or low level when VDD is off.

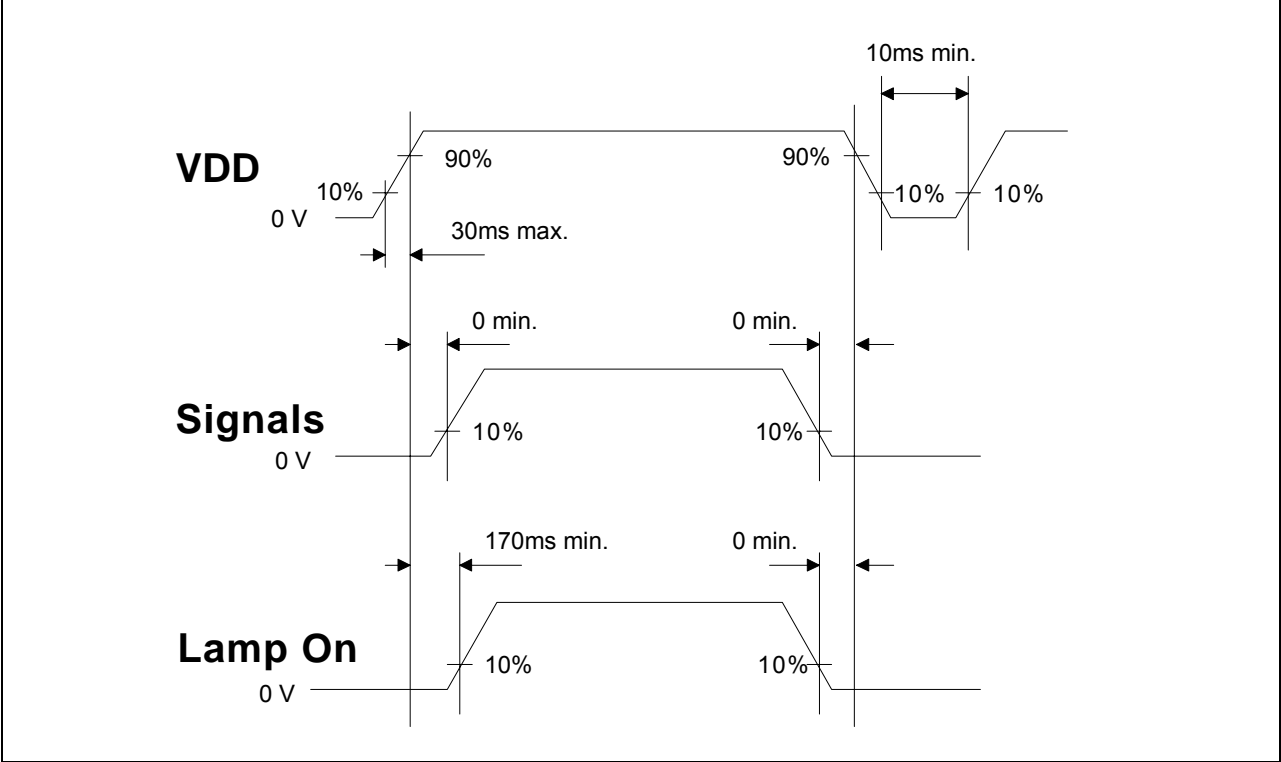

## 11.0 Environment

The display module will meet the provision of this specification during operating condition or after storage or shipment condition specified below. Operation at 10% beyond the specified range will not cause physical damage to the unit.

### 11.1 Temperature and Humidity

#### 11.1.1 Operating Conditions

The display module operates error free, when operated under the following conditions;

Temperature	0 °C to 50 °C
Relative Humidity	8% to 95%
Wet Bulb Temperature	39.0 °C

#### 11.1.2 Shipping Conditions

The display module operates error free, after the following conditions;

Temperature	-20 °C to 60 °C
Relative Humidity	8% to 95%
Wet Bulb Temperature	39.0 °C

## 11.2 Atmospheric Pressure

The display assembly is capable of being operated without affecting its operations over the pressure range as following specified;

	Pressure	Note
Maximum Pressure	1040hPa	0m = sea level
Minimum Pressure	674hPa	3048m = 10.000 feet

Note : Non-operation attitude limit of this display module = 30,000 feet. = 9145 m.

## 11.3 Thermal Shock

The display module will not sustain damage after being subjected to 100 cycles of rapid temperature change. A cycle of rapid temperature change consists of varying the temperature from -20°C to 60°C, and back again.

<b>Thermal shock cycle</b>	-20 °C for 30min
	60 °C for 30min

Power is not applied during the test. After temperature cycling, the unit is placed in normal room ambient for at least 4 hours before powering on.

## 12.0 Reliability

This display module and the packaging of that will comply following standards.

### 12.1 Failure Criteria

The display assembly will be considered as failing unit when it no longer meets any of the requirements stated in this specification. Only as for maximum white luminance, following criteria is applicable.

### 12.2 Failure Rate

The average failure rate of the display module (from first power-on cycle till 1,000 hours later) will not exceed 1.0%. The average failure rate of the display module from 1,000 hours until 10,000 hours will not exceed 0.70% per 11000 hours. Above failure rates correspond to the field performance of 0.0016/MM for 1+30 and 0.0010/MM for FF.

#### 12.2.1 Usage

The assumed usage for the above criteria is:

- 220 power-on hours per month
- 500 power on/off cycles per month
- Maximum brightness setting
- Operation to be within office environment (25°C typical)

#### 12.2.2 Component De-rating

All the components used in this device will be checked the load condition to meet the failure rate criteria.

### 12.3 CCFL Life

The assumed CCFL Life will be longer than 20,000 hours at the general test condition.

### 12.4 ON/OFF Cycle

The display module will be capable of being operated over the following ON/OFF Cycles.

ON/OFF	Value	Cycle
+Vin and CCFL power	35,000	10 seconds on/10 seconds off

## **13.0 Safety**

### **13.1 Sharp Edge Requirements**

There will be no sharp edges or comers on the display assembly that could cause injury.

### **13.2 Materials**

#### **13.2.1 Toxicity**

There will be no carcinogenic materials used anywhere in the display module. If toxic materials are used, they will be reviewed and approved by the responsible ADT Toxicologist.

#### **13.2.2 Flammability**

All components including electrical components that do not meet the flammability grade UL94-V1 in the module will complete the flammability rating exception approval process. The printed circuit board will be made from material rated 94-V1 or better. The actual UL flammability rating will be printed on the printed circuit board.

### **13.3 Capacitors**

If any polarized capacitors are used in the display assembly, provisions will be made to keep them from being inserted backwards.

### **13.4 Hazardous Voltages**

Any point exceeding 42.4 volts meets the requirement of the limited current circuit. The current through a  $2K\Omega$  resistance is less than  $0.7 \times f$  (kHz) mA.

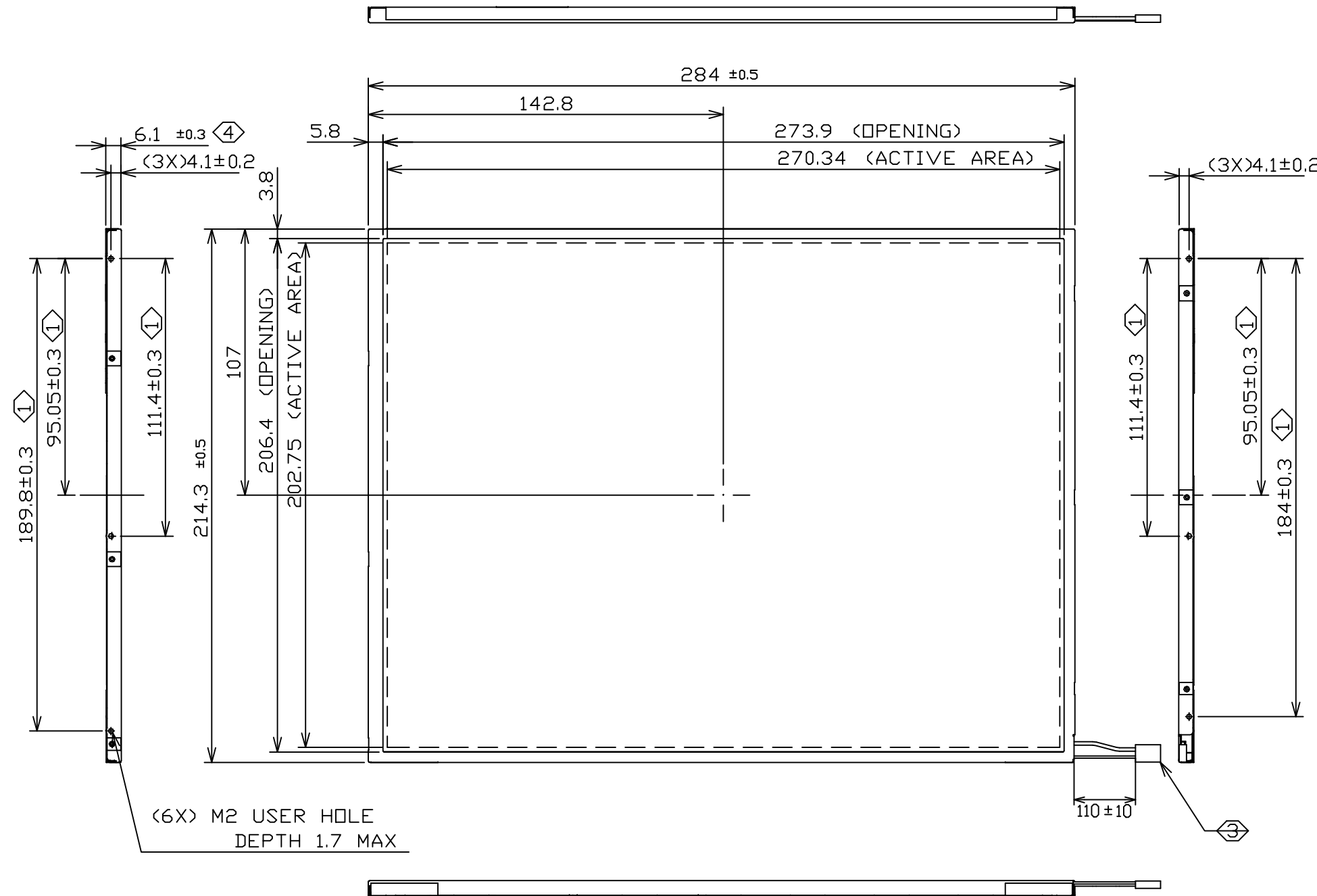

NOTE

- ① THESE HOLES TO BE USED FOR FIXING PANEL.
- ② IF CONNECTOR TO BE JAE CO.,LTD.  
THIS PART NUMBER TO BE "FI SEB20P-HF13".
- ③ LAMP CONNECTOR TO BE JST CO.,LTD.  
THIS PART NUMBER TO BE "BHSR-02VS-1".
- ④ THIS DIMENSION EXCLUDES DEFORMATION.
- ⑤ UNSPECIFIED TOLERANCE TO BE  $\pm 0.5\text{mm}$ .

CHECH ITEMS

- 1 DIMENSION  $284\pm0.5$ ,  $214.3\pm0.5$ ,  $6.1\pm0.3$   
CABLE LENGTH  $135\pm5$  CAN NOT OUT OF SPEC.
- 2 SCREW HOLES M2 SHOULD MEET REQUIREMENT  
MEASURE BY SCREW GAUGE.
- 3 ALL APPEARANCE COMPONENTS CAN NOT BE  
DIRTY, OILY, AND BURRS.
- 4 THE CLEARANCE BETWEEN BEZEL AND GLASS  
SURFACE TO BE  $0.5\text{mm}$  MAX.

