

1. Scope of Application

These specifications apply to chip type LED lamp, model CL-L270-MU1L1-A1-T.

2. Part code

C L - L 2 7 0 - M U 1 L 1 - A 1 - T

Series

L270 : White LED for general lighting.

Quantity of dies

No Sign: 1Die.

Special specifications

M : General Color Rendering Index Typ.85 type.

Watt class

U1 : Under 1 watt package.

Lighting color

L1 : Compliance with ANSI C78.377-2008, 3-step MacAdam ellipse,
Correlated Color Temperature 3000K.

Shipping mode

Non-coded : Bulk

T : Taping (standard)

Symbol	CITILED
Name	CL-L270-MU1L1-A1
CITIZEN ELECTRONICS CO.,LTD. JAPAN	

3. Outline drawing

Unit: mm
Tolerance: ±0.1

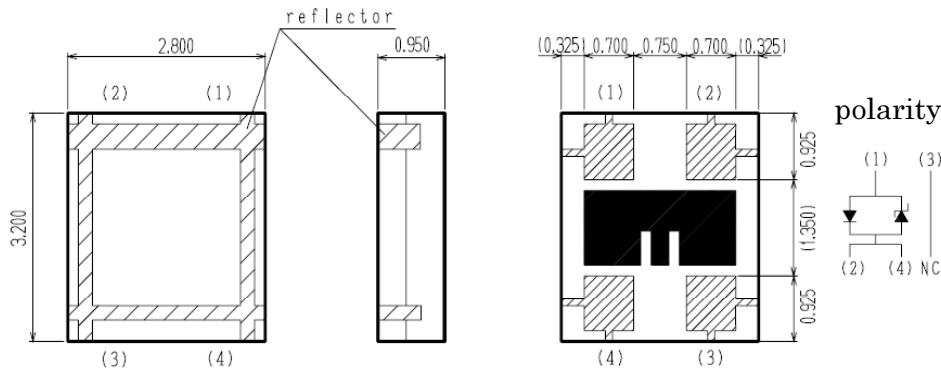

4. Performance

(1) Absolute Maximum Rating

Parameter	Symbol	Rating Value	Unit
Power Dissipation	P_D	0.28	W
Forward Current	I_F	80	mA
Forward Pulse Current	I_{FP}	100	mA
Reverse Current	I_R	1	mA
Operating Temperature	T_{op}	-30 ~ +85	C
Storage Temperature	T_{st}	-40 ~ +100	C
Junction Temperature	$T_{jMax.}$	120	C

*1 Forward Current : Duty \leq 1/10, Pulse width \leq 10 msec

*2 D.C. Current : $T_j = T_s + R_{j-s} \times P_D$

Pulse Current : $T_j = T_s + R_{j-s} \times P_W$ (Power Dissipation / One-Pulse) \times Duty

* T_s :Temperature of Solder terminal(4)

(2) Electro-optical Characteristic

($T_s=25C$)

Parameter	Symbol	Condition	Min.	Typ.	Max.	Unit
Forward Voltage	V_F	$I_F=60mA$	2.8	3.1	3.4	V
Thermal resistance	R_{j-s}	junction-solder	-	95	-	C/W
Luminous Flux	ϕ_V	$I_F=60mA$	12.3	16.4	20.5	lm
General Color Rendering Index	Ra	$I_F=60mA$	80	85	-	-

Rank information

CUSTOMER:
TYPE: CL-L270-MU1L1-A1
P.NO:
Lot No: XXXXXX
Q'ty: XXX

PASS

CITIZEN ELECTRONICS

e.g. Q 1 B

Q 1 B
□ △ ■

- : Ranking by Forward Voltage
- △ : Ranking by Chromaticity coordinates
- : Ranking by Luminous Intensity

Symbol	CITLED
Name	CL-L270-MU1L1-A1
CITIZEN ELECTRONICS CO.,LTD. JAPAN	

Chromaticity coordinates (Condition : IF=60mA , Ts=25C)

Color rank	Center	
L1	x	y
	0.4338	0.4030
	Oval parameter	
	a	0.00834
	b	0.00408
	θ°	53.17

Reference (ANSI C78.377)

Color rank	Center	x	y
L1	Center	0.4338	0.4030
	a	0.4562	0.4260
	b	0.4299	0.4165
	c	0.4147	0.3814
	d	0.4373	0.3893

(3045K)

*Color region stay within MacAdam "3-step" ellipse from the chromaticity center.

*The chromaticity center refers to ANSI C78.377:2008.

Please refer to ANSI C78.377 for the chromaticity center.

* θ is the angle between the major axis of the ellipse and the x-axis,
and a and b are the major and minor semi-axes of an ellipse. (Ref. IEC 60081:1997 AnnexD)

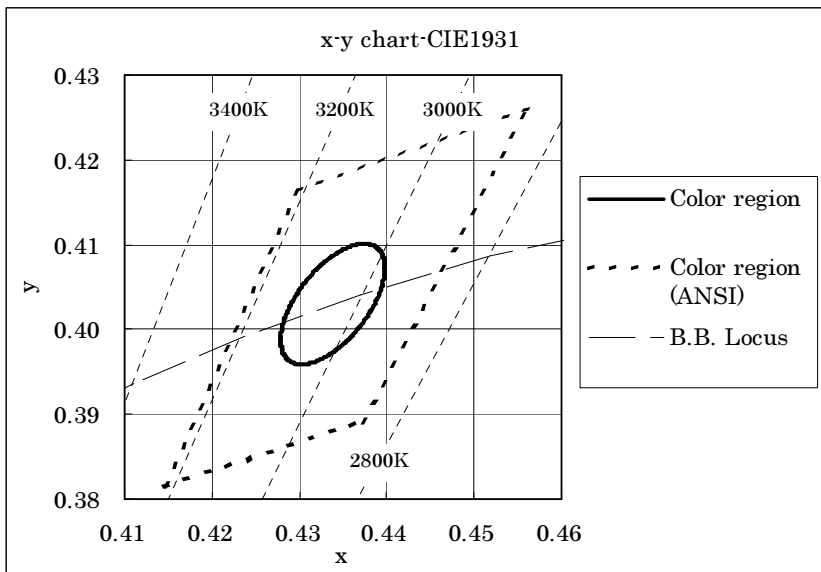

Ranking(Condition:IF=60mA, Ts=25C)

Parameter	Symbol	Rank	Min.	Max.	Unit
Forward Voltage	V_F	Q	2.80	3.00	V
		R	3.00	3.20	
		S	3.20	3.40	
Luminous Flux	ϕ_V	B	12.3	15.0	lm
		C	15.0	17.7	
		D	17.7	20.5	

Note 1) The tolerance of forward voltage(V_F) measurement is $V_F \pm 3\%$ at our tester

Note 2) The tolerance of luminous Intensity(I_V) measurement is $\pm 10\%$ at our tester

Note 3) The tolerance of Chromaticity coordinates (x,y)measurement is ± 0.01 at our tester

Measurement Conditions

- 1) Chip is mounted on board(size 100mm×40mm)
- 2) Board material is FR-4, covered with green color resist and thickness of copper is 18 μ m.

Symbol	CITILED
Name	CL-L270-MU1L1-A1
CITIZEN ELECTRONICS CO.,LTD. JAPAN	

5. Characteristic

• Forward Current vs. Relative Luminous Intensity

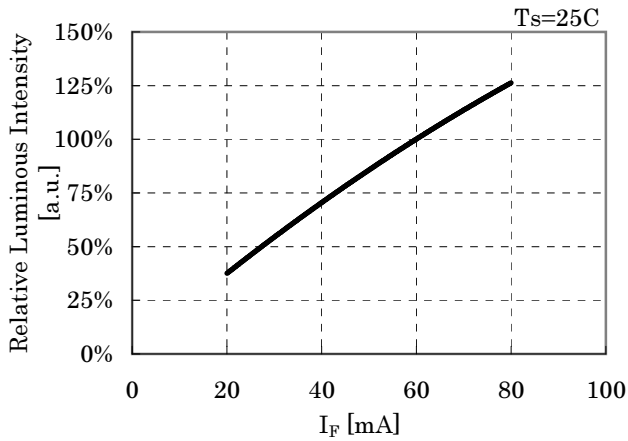

• Forward Current vs. Forward Voltage

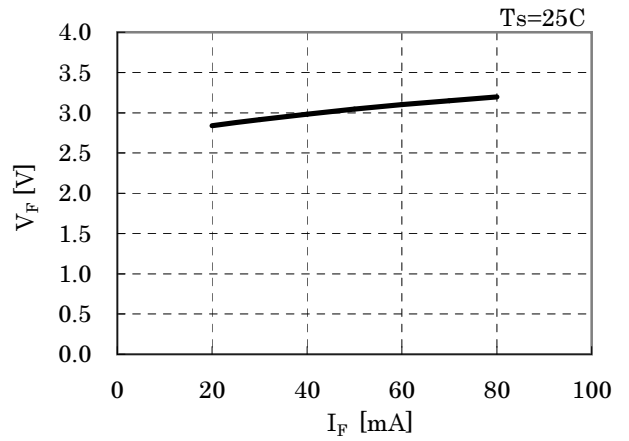

• Solder Temperature vs. Relative Luminous Intensity

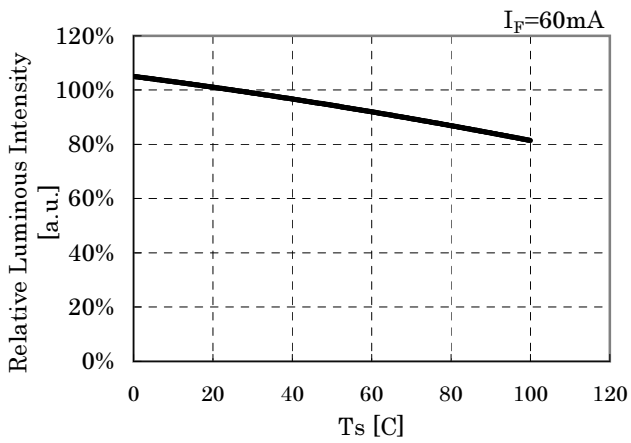

• Solder Temperature vs. Forward Voltage

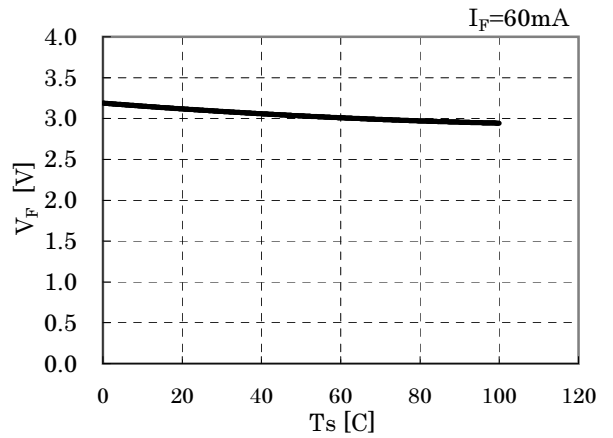

• Solder Temperature vs. Allowable Forward Current

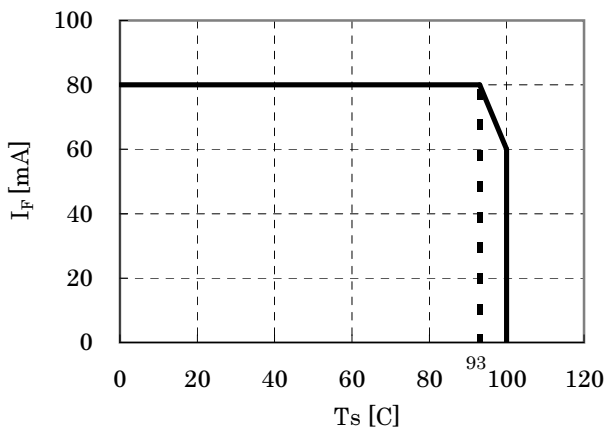

<Condition>
 Chip on board
 board size:100mm×40mm
 Materials:FR-4
 Thickness of Copper:18um

Symbol	CITLED
Name	CL-L270-MU1L1-A1
CITIZEN ELECTRONICS CO.,LTD. JAPAN	

5. Characteristic (2)

• Forward Current vs. Chromaticity Coordinate

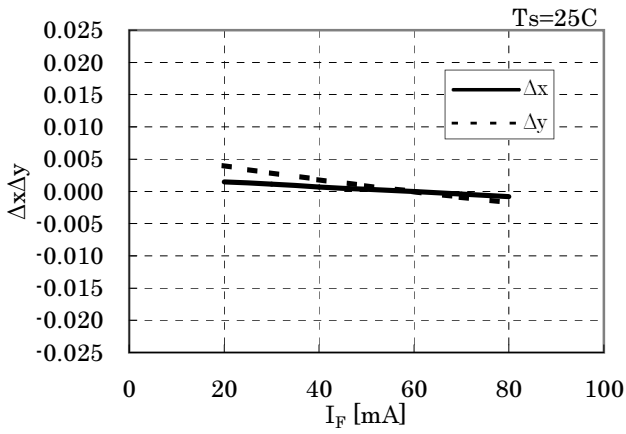

• Solder Temperature vs. Chromaticity Coordinate

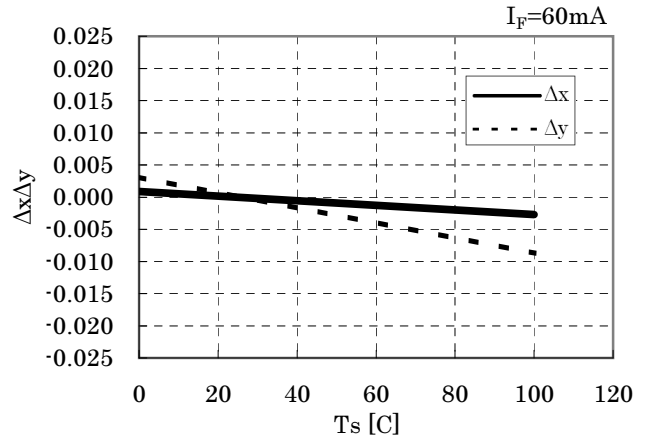

Directive Characteristic

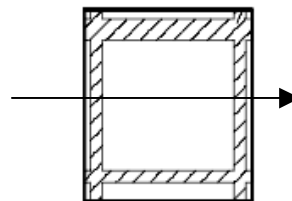
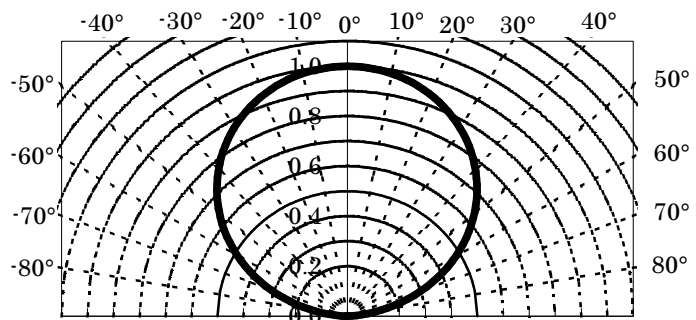
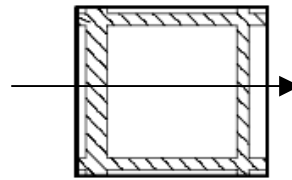
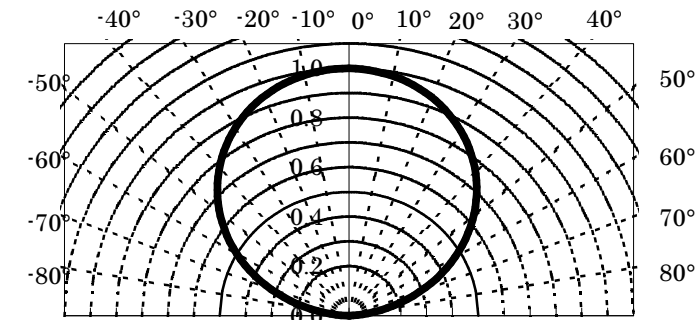

Symbol	CITLED
Name	CL-L270-MU1L1-A1
CITIZEN ELECTRONICS CO.,LTD. JAPAN	

6. Reliability

(1) Details of the tests

Test Item	Test Condition
Life Test in Continuous Operation	Ta=25 C, IF=60 mA × 1000 hours
Low Temperature Storage Test	Ta=-40 C × 1000 hours
High Temperature Storage Test	Ta=100 C × 1000 hours
Moisture-proof Test	Ta=60 C, 90 %RH for 1000 hours
Thermal Shock Test	Ta=-40 C × 30 minutes and Ta=100 C × 30 minutes, 100cycle
Solder Heat Resistance Test	Recommended temperature profile (reflow soldering)× 2, (2nd test must be started after the samples are stabilized thermally.)

(2) Judgment Criteria of Failure for Reliability Test

Measuring Item	Symbol	Measuring Conditon	Judgement Criteria for Failure
Forward Voltage	V _F	I _F =60mA	> U×1.2
Luminous Intensity	I _V	I _F =60mA	< S×0.7

U means the upper limit of the specified characteristics.

S means the initial value.

Note: Measurement shall be taken between 2 hours and 24 hours, having returned the test pieces to the normal ambient conditions after the completion of each test.

Symbol	CITILED
Name	CL-L270-MU1L1-A1
CITIZEN ELECTRONICS CO.,LTD. JAPAN	

7. Taping Specifications (in accordance with JIS standard)

(1) Shape and Dimensions of Reel

(Unit: mm)

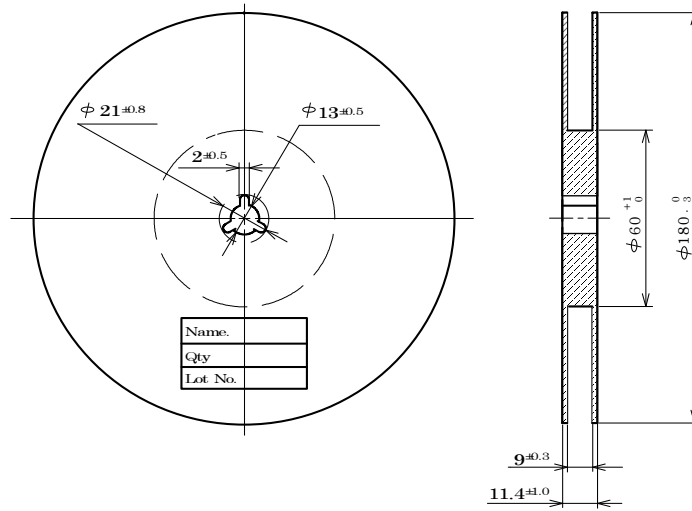

(2) Dimensions of Tape

(Unit: mm)

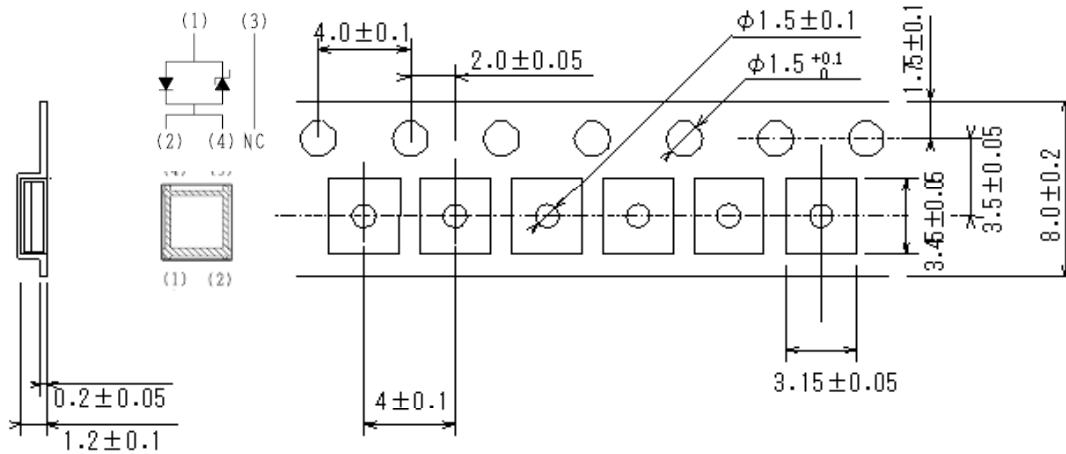

(3) Configuration of Tape

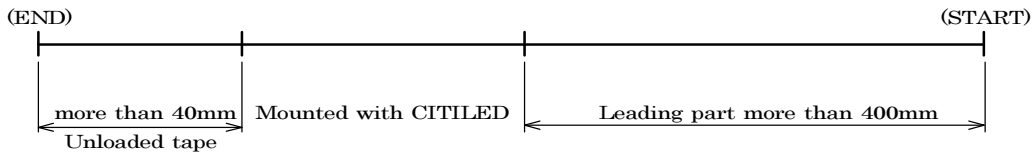

(4) Quantity: 3000pcs/reel

Symbol	CITLED
Name	CL-L270-MU1L1-A1
CITIZEN ELECTRONICS CO.,LTD. JAPAN	

8. Packing Specifications

8-1. Moisture-proof Packing

To prevent moisture absorption during transportation and storage, reels are packed in aluminum envelopes which contain a desiccant with a humidity indicator.

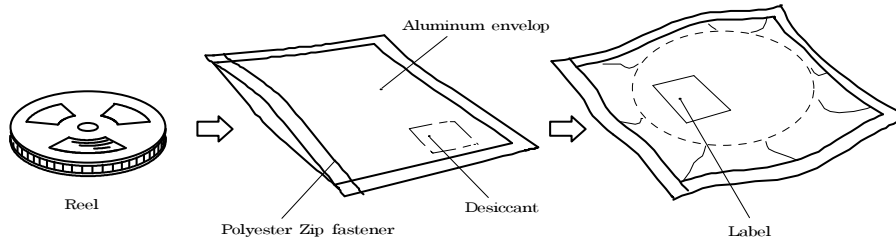

8-2. Storage

To prevent moisture absorption, it is strongly recommended that reels (in bulk or taped) should be stored in the dry box (or the desiccator) with a desiccant as the appropriate storage place. If not, the following is recommended.

Temperature: 5 ~ 30 C
 Humidity: 60%RH max

The devices should be mounted as soon as possible after unpacking. If you store the unpacked reels, please store them in the dry box or seal them into the envelop again.

Moisture Sensitive Level1 (IPC/JEDEC J-STD-020C)

Symbol	CITILED
Name	CL-L270-MU1L1-A1
CITIZEN ELECTRONICS CO.,LTD. JAPAN	

9. Precautions

9-1. Soldering

(1) Lead free soldering

1) Following soldering paste is recommended

Melting temperature: 216 ~ 220 C.

Composition: Sn / 3.5Ag / 0.75Cu

2) The temperature profile at the top surface of the parts is recommended as shown below.

3) It is requested that products should be handled after their temperature has dropped down to the normal room temperature

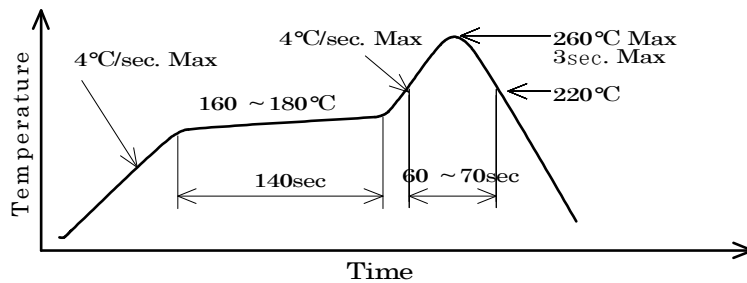

9-2. Washing

(1) When washing after soldering is needed, following conditions are requested.

a) Washing solvent: Pure Water

b) Temperature, time: 50 C or less × 30 seconds max.
or 30 C or less × 3 minutes max.

c) Ultrasonic washing: 300W or less

9-3. Other directions

(1) It is requested to avoid any stress added to the resin portion while it is heated.

(2) It is requested to avoid any friction by sharp metal nail etc. to the resin portion.

(3) For outdoor use, necessary measures should be taken to prevent water, moisture and salt air damage.

This product is NOT designed with following conditions in mind.

In water, oil, medicament, organic solvent and dust-laden environment.

Symbol	CITILED
Name	CL-L270-MU1L1-A1
CITIZEN ELECTRONICS CO.,LTD. JAPAN	

10. Designing precautions

- (1) The current limiting resistor should be placed in the circuit so that is driven within its rating. Also avoid reverse voltage (over-current) applied instantaneously when ON or OFF.
- (2) When pulse driving current is applied, average current consumption should be within the rating. Also avoid reverse voltage applied when put off.
- (3) Recommended soldering pattern

<For reflow soldering>

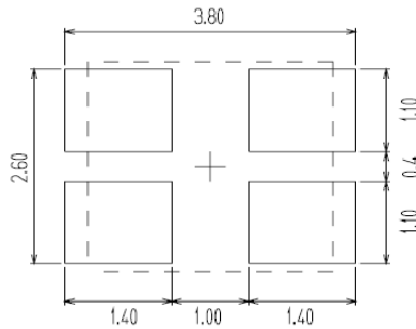

Unit : mm

Mountability and solderability need to be optimized with actual conditions such as amount of solder, reflow temperature applied in the process.

- (4) When assembling the circuit board into the finished products, care must be taken to avoid the component parts from touching other parts.
- (5) When using multiple LEDs, it is required to connect a current limiting resistor on each path which the current flows to the LEDs.

(ex-1)

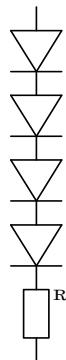

(ex-2)

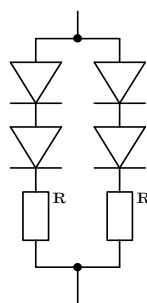

(ex-3)

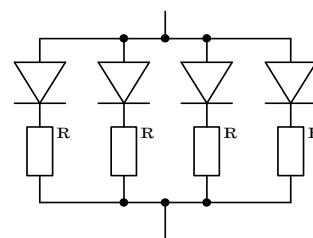

(6) Other

- 1) This product complies with RoHS directives.

Symbol	CITILED
Name	CL-L270-MU1L1-A1
CITIZEN ELECTRONICS CO.,LTD. JAPAN	

11. Precautions with regard to product use

1. This document is provided for reference purposes only so that CITIZEN ELECTRONICS' products are used as intended. CITIZEN ELECTRONICS neither makes warranties or representations with respect to the accuracy or completeness of the information contained in this document nor grants any license to any intellectual property rights or any other rights of CITIZEN ELECTRONICS or any third party with respect to the information in this document.

2. All information included in this document such as product data, diagrams, charts, is current as of the date this document is issued.
Such information, however, is subject to change without any prior notice.
Before purchasing or using any CITIZEN ELECTRONICS' products listed in this document, please confirm the latest product information with a CITIZEN ELECTRONICS' sales office, and formal specifications must be exchanged and signed by both parties prior to mass production.

3. CITIZEN ELECTRONICS has used reasonable care in compiling the information included in this document, but CITIZEN ELECTRONICS assumes no liability whatsoever for any damages incurred as a result of errors or omissions in the information included in this document.

4. Absent a written signed agreement, except as provided in the relevant terms and conditions of sale for product, and to the maximum extent allowable by law, CITIZEN ELECTRONICS assumes no liability whatsoever, including without limitation, indirect, consequential, special, or incidental damages or loss, including without limitation, loss of profits, loss of opportunities, business interruption and loss of data, and disclaims any and all express or implied warranties and conditions related to sale, use of product, or information, including warranties or conditions of merchantability, fitness for a particular purpose, accuracy of information, or no infringement.

5. Though CITIZEN ELECTRONICS works continually to improve products' quality and reliability, products can malfunction or fail. Customers are responsible for complying with safety standards and for providing adequate designs and safeguards to minimize risk and avoid situations in which a malfunction or failure of a product could cause loss of human life, bodily injury or damage to property, including data loss or corruption.
In addition, customers are also responsible for determining the appropriateness of use of any information contained in this document such as application cases not only with evaluating by their own but also by the entire system.
CITIZEN ELECTRONICS assumes no liability for customers' product design or applications.

Symbol	CITILED
Name	CL-L270-MU1L1-A1
CITIZEN ELECTRONICS CO.,LTD. JAPAN	

6. Eye Safety

- The International Electrical Commission (IEC) published in 2006 IEC 62471 "2006 Photobiological safety of lamps and lamp systems" which includes LEDs within its scope. When sorting single LEDs according to IEC 62471, most LEDs can be classified as belonging to either Exempt Group or Risk Group 1.
- Optical characteristics of LEDs such as radiant flux, spectrum and light distribution are factors that affect the risk group determination of the LED, and especially a high-power LED, that emits light containing blue wavelengths, may have properties equivalent to those of Risk Group 2.
- Great care should be taken when directly viewing an LED that is driven at high current, has multiple uses as a module or when focusing the light with optical instruments, as these actions may greatly increase the hazard to your eyes.
- In addition, LED sources that were included within the scope of IEC 60825-1 / Edition 1.2 "laser safety standard", published 2001 were removed from the scope of the IEC 60825-1 / Edition 2.0 revised 2007.
- However, keep in mind that some countries and regions have adopted standards based on the IEC laser safety standard IEC 60825-1:2001 which includes LEDs within its scope.

7. Please contact CITIZEN ELECTRONICS' sales office if you have any questions regarding the information contained in this document, or if you have any other inquiries.

Symbol	CITILED
Name	CL-L270-MU1L1-A1
CITIZEN ELECTRONICS CO.,LTD. JAPAN	