

## N-channel MOSFET

### Features

- High ruggedness
- $R_{DS(ON)}$  (Max 1.45  $\Omega$ )@ $V_{GS}=10V$
- Gate Charge (Typ 60nC)
- Improved dv/dt Capability
- 100% Avalanche Tested

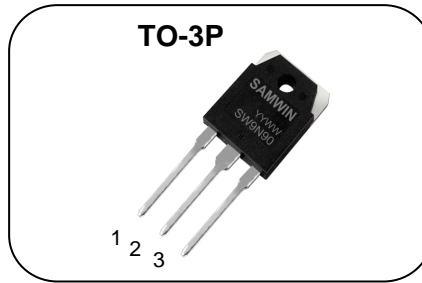

1. Gate 2. Drain 3. Source

$BV_{DSS}$  : 900V

$I_D$  : 9.0A

$R_{DS(ON)}$  : 1.45ohm

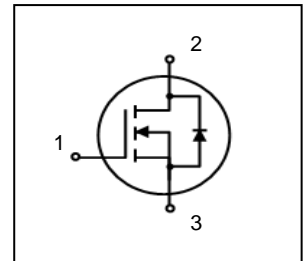

### General Description

This power MOSFET is produced with advanced VDMOS technology of SAMWIN. This technology enable power MOSFET to have better characteristics, such as fast switching time, low on resistance, low gate charge and especially excellent avalanche characteristics. It is mainly suitable for half bridge or full bridge resonant topology like a electronic ballast, and also low power switching mode power appliances.

### Order Codes

Item	Sales Type	Marking	Package	Packaging
1	SW W 9N90	SW9N90	TO-3P	TAPE

### Absolute maximum ratings

Symbol	Parameter	SW9n90		Unit
		TO-3P		
$V_{DSS}$	Drain to Source Voltage	900		V
$I_D$	Continuous Drain Current (@ $T_C=25^\circ C$ )	9.0		A
	Continuous Drain Current (@ $T_C=100^\circ C$ )	5.6		A
$I_{DM}$	Drain current pulsed (note 1)	36		A
$V_{GS}$	Gate to Source Voltage	$\pm 30$		V
$E_{AS}$	Single pulsed Avalanche Energy (note 2)	850		mJ
$E_{AR}$	Repetitive Avalanche Energy (note 1)	25		mJ
dv/dt	Peak diode Recovery dv/dt (note 3)	4.5		V/ns
$P_D$	Total power dissipation (@ $T_C=25^\circ C$ )	240		W
	Derating Factor above 25°C	1.92		W/°C
$T_{STG}, T_J$	Operating Junction Temperature & Storage Temperature	-55 ~ + 150		°C
$T_L$	Maximum Lead Temperature for soldering purpose, 1/8 from Case for 5 seconds.	300		°C

### Thermal characteristics

Symbol	Parameter	Value			Unit
		Min.	Typ.	Max.	
$R_{thjc}$	Thermal resistance, Junction to case			0.52	°C/W
$R_{thcs}$	Thermal resistance, Case to Sink	0.24			°C/W
$R_{thja}$	Thermal resistance, Junction to ambient		40		°C/W

### Electrical characteristic ( $T_C = 25^\circ\text{C}$ unless otherwise specified )

Symbol	Parameter	Test conditions	Min.	Typ.	Max.	Unit
<b>Off characteristics</b>						
$BV_{DSS}$	Drain to source breakdown voltage	$V_{GS}=0V, I_D=250\mu A$	900	-	-	V
$\Delta BV_{DSS} / \Delta T_J$	Breakdown voltage temperature coefficient	$I_D=250\mu A$ , referenced to $25^\circ\text{C}$	-	1.0	-	$V/^\circ\text{C}$
$I_{DSS}$	Drain to source leakage current	$V_{DS}=900V, V_{GS}=0V$	-	-	10	$\mu A$
		$V_{DS}=720V, T_C=125^\circ\text{C}$	-	-	100	$\mu A$
$I_{GSS}$	Gate to source leakage current, forward	$V_{GS}=30V, V_{DS}=0V$	-	-	100	nA
	Gate to source leakage current, reverse	$V_{GS}=-30V, V_{DS}=0V$	-	-	-100	nA
<b>On characteristics</b>						
$V_{GS(TH)}$	Gate threshold voltage	$V_{DS}=V_{GS}, I_D=250\mu A$	3.0	-	5.0	V
$R_{DS(ON)}$	Drain to source on state resistance	$V_{GS}=10V, I_D = 4.5A$		1.1	1.45	$\Omega$
<b>Dynamic characteristics</b>						
$C_{iss}$	Input capacitance	$V_{GS}=0V, V_{DS}=25V, f=1\text{MHz}$			2700	pF
$C_{oss}$	Output capacitance				260	
$C_{riss}$	Reverse transfer capacitance				35	
$t_{d(on)}$	Turn on delay time	$V_{DS}=450V, I_D=9A, R_G=50\Omega$			100	ns
$t_r$	Rising time				210	
$t_{d(off)}$	Turn off delay time				280	
$t_f$	Fall time				170	
$Q_g$	Total gate charge	$V_{DS}=720V, V_{GS}=10V, I_D=9A$		60	72	nC
$Q_{gs}$	Gate-source charge			12	-	
$Q_{gd}$	Gate-drain charge			26	-	

### Source to drain diode ratings characteristics

Symbol	Parameter	Test conditions	Min.	Typ.	Max.	Unit
$I_S$	Continuous source current	Integral reverse p-n Junction diode in the MOSFET	-	-	9	A
$I_{SM}$	Pulsed source current		-	-	36	A
$V_{SD}$	Diode forward voltage drop.	$I_S=9A, V_{GS}=0V$	-	-	1.5	V
$T_{rr}$	Reverse recovery time	$I_S=9A, V_{GS}=0V,$	-	720	-	ns
$Q_{rr}$	Breakdown voltage temperature	$di_f/dt=100A/\mu s$	-	7.6	-	$\mu C$

#### ※. Notes

1. Repetitive rating : pulse width limited by junction temperature.
2.  $L = 23\text{mH}, I_{AS} = 9.0A, V_{DD} = 50V, R_G=25\Omega$ , Starting  $T_J = 25^\circ\text{C}$
3.  $I_{SD} \leq 9.0A, di/dt = 300A/\mu s, V_{DD} \leq BV_{DSS}$ , Starting  $T_J = 25^\circ\text{C}$
4. Pulse Test : Pulse Width  $\leq 300\mu s$ , duty cycle  $\leq 2\%$
5. Essentially independent of operating temperature.

Fig. 1. On-state characteristics

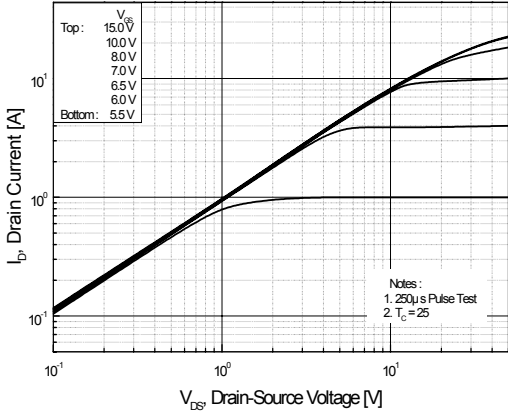

Fig. 2. Transfer characteristics

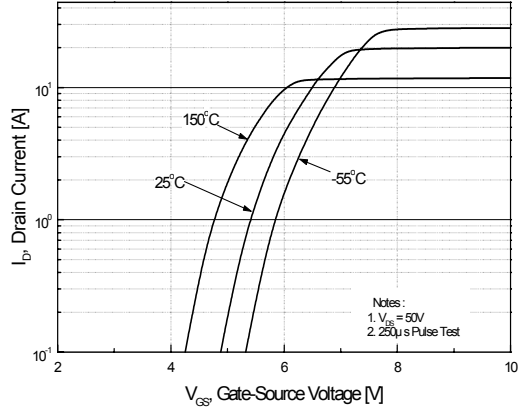

Fig. 3. On-resistance variation vs. drain current and gate voltage

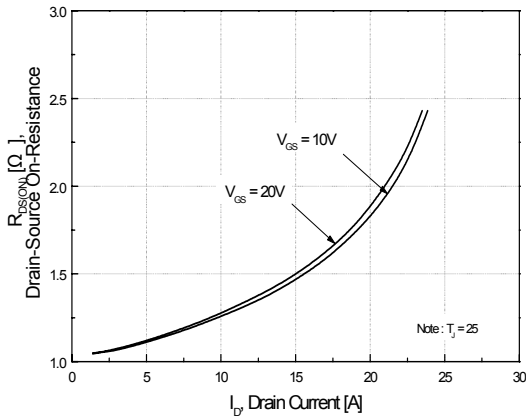

Fig. 4. On state current vs. diode forward voltage

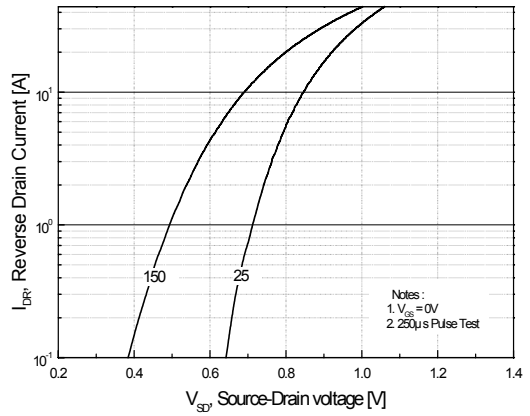

Fig. 5. Capacitance characteristics (Non-Repetitive)

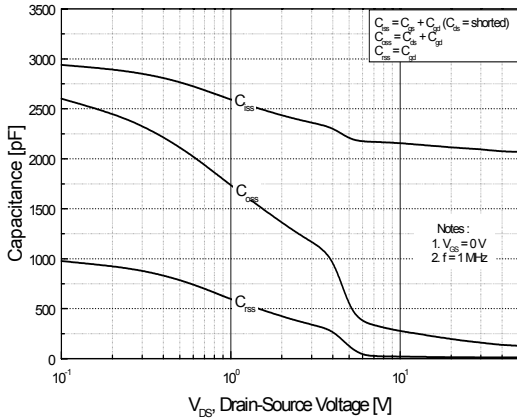
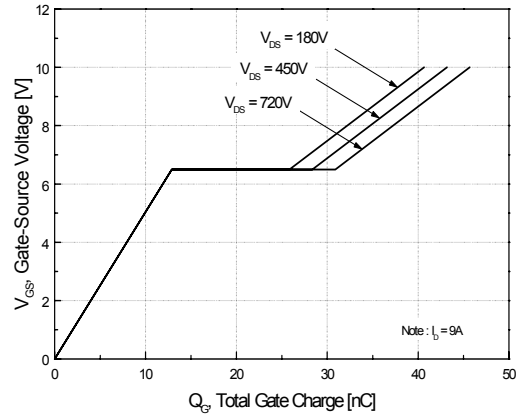
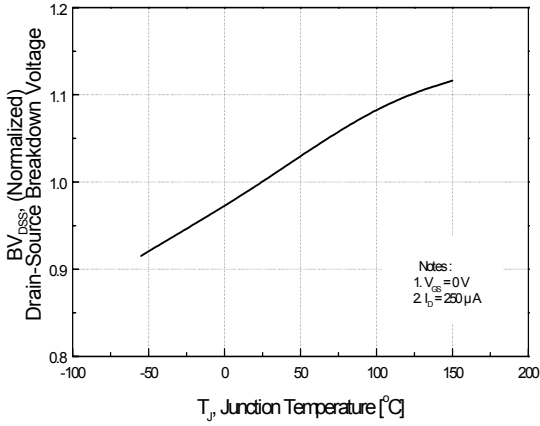

Fig. 6. Gate charge characteristics



**Fig 7. Breakdown Voltage Variation vs. Junction Temperature**



**Fig. 8. On resistance variation vs. junction temperature**

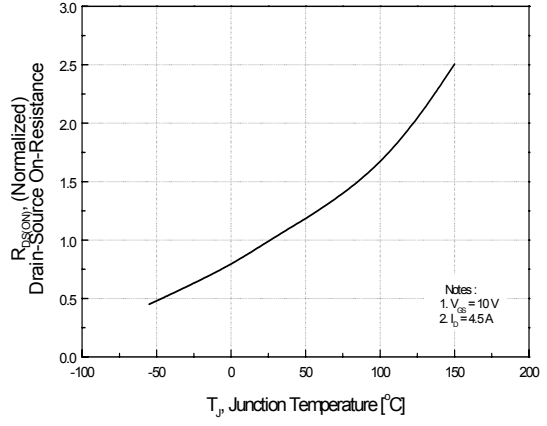

**Fig. 9. Maximum drain current vs. case temperature.**

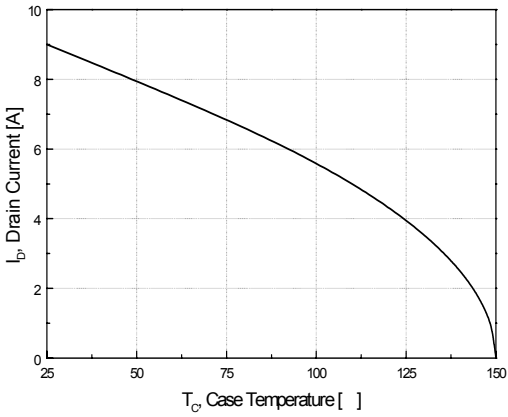

**Fig. 10. Maximum safe operating area**

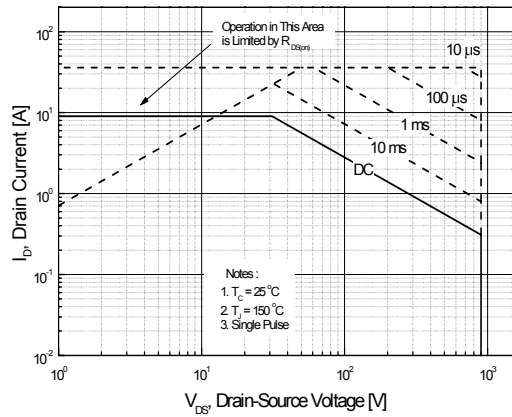

**Fig. 11. Transient thermal response curve**

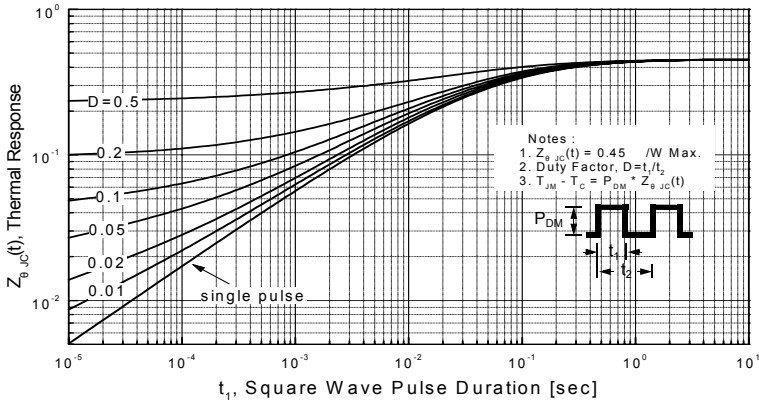

Fig. 12. Gate charge test circuit & waveform

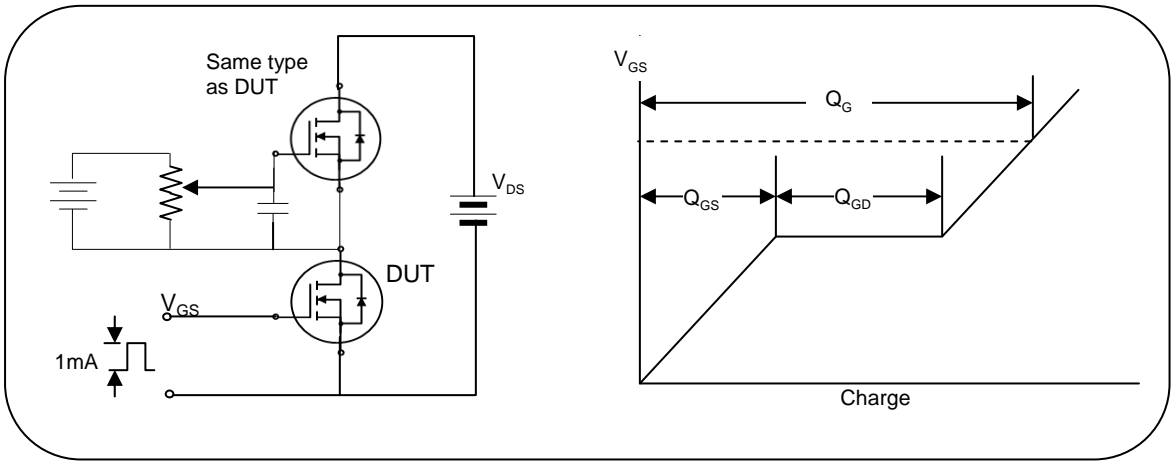

Fig. 13. Switching time test circuit & waveform

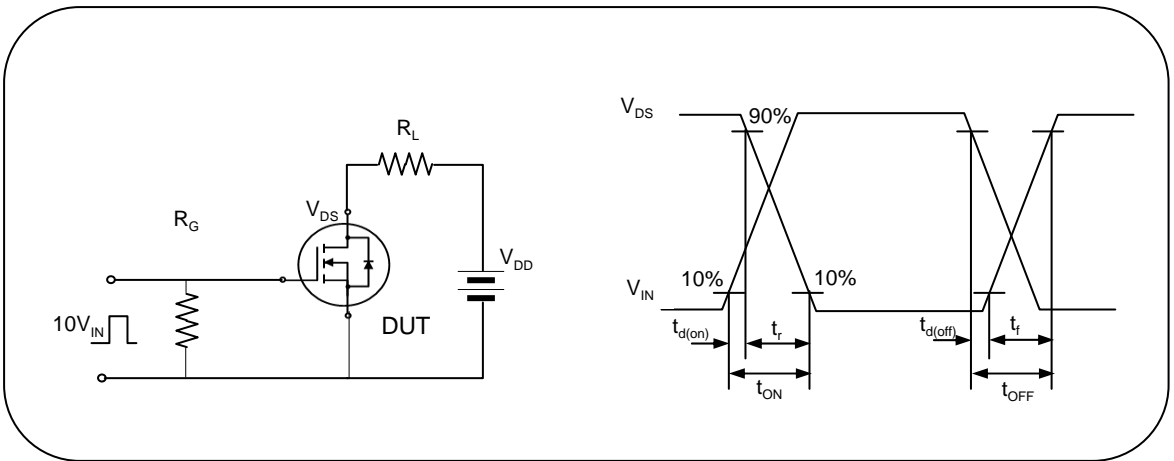

Fig. 14. Unclamped Inductive switching test circuit & waveform

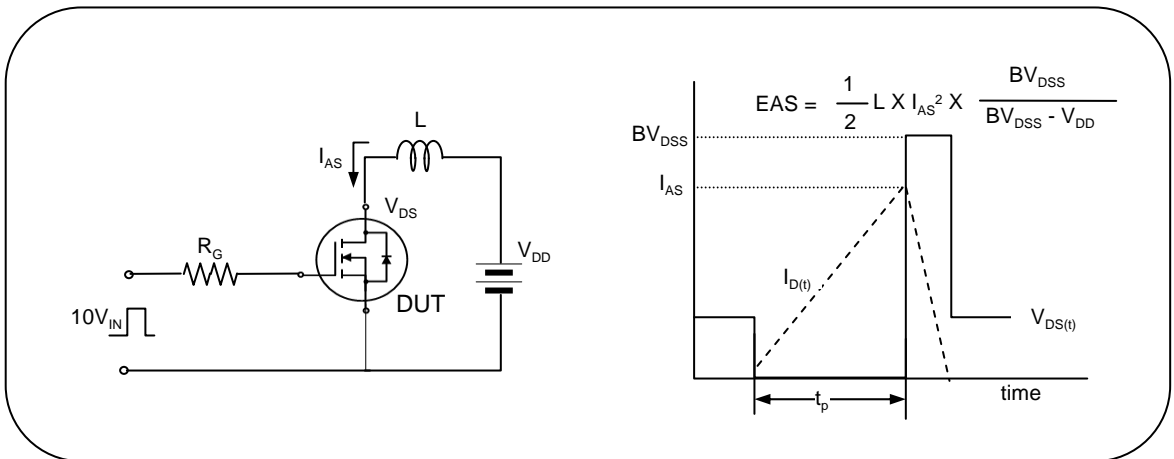
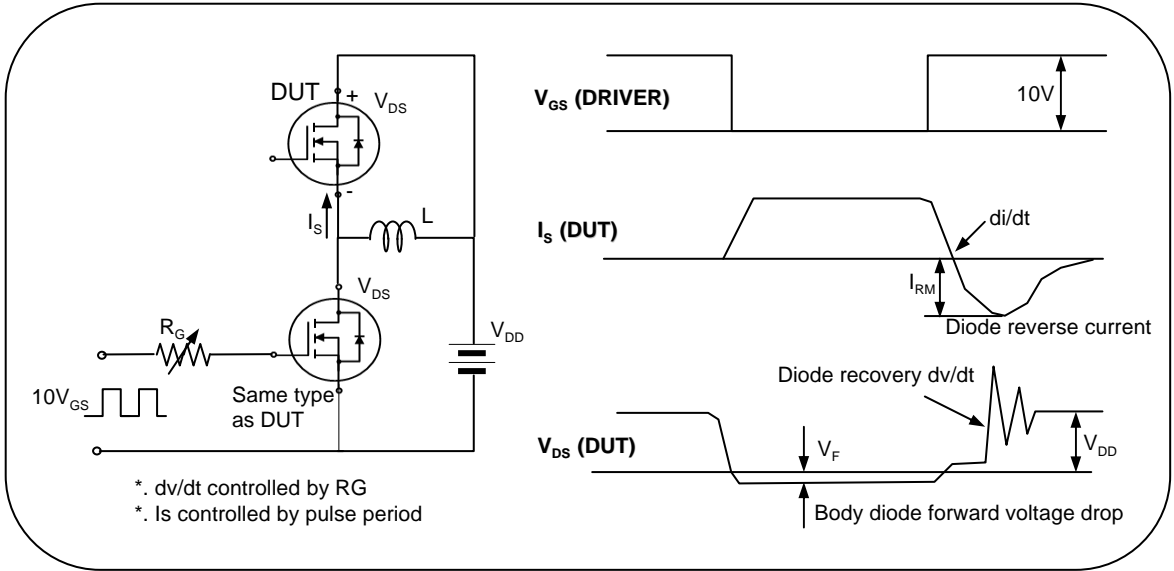

Fig. 15. Peak diode recovery dv/dt test circuit & waveform



## REVISION HISTORY

Revision No.	Changed Characteristics	Responsible	Date	Issuer
REV 1.0	Origination, First Release	Alice Nie	2007.12.05	XZQ
REV 2.0	Updated the format of datasheet and added Order Codes.	Alice Nie	2011.03.24	XZQ
REV 3.0	Confirmed the VTH characteristic	Alice Nie	2011.09.16	XZQ

[WWW.SEMIPOWER.COM.CN](http://WWW.SEMIPOWER.COM.CN)



芯派科技  
SEMIPOWER

西安芯派电子科技有限公司

地址：西安市高新区高新一路25号创新大厦MF6

电话：029 - 88253717 传真：029 - 88251977



芯源科技

SAMWIN

深圳市南方芯源科技有限公司

地址：深圳市福田区天安数码城时代大厦A座2005

电话：0755 - 83981818 传真：0755 - 83476838