

# PRESSURE TRANSMITTER (DIRECT MOUNT TYPE)

DATA SHEET

FKP...5

The FCX-AIII pressure transmitter accurately measures gauge pressure and transmits proportional 4 to 20mA signal.

The transmitter utilizes the unique micromachined capacitive silicon sensor with state-of-the-art microprocessor technology to provide exceptional performance and functionality.

## FEATURES

### 1. High accuracy $\pm 0.1\%$

0.1% accuracy is a standard feature. Fuji's micro-capacitance silicon sensor assures this accuracy for all elevated or suppressed calibration ranges without additional adjustment.

### 2. Minimum environmental influence

The "Advance Floating Cell" design which protects the pressure sensor against changes in temperature, and overpressure substantially reduces total measurement error in actual field applications.

### 3. Fuji/HART® bilingual communications protocol

FCX-AIII series transmitter offers bilingual communications to speak both Fuji proprietary protocol and HART®. Any HART® compatible devices can communicate with FCX-AIII.

### 4. Application flexibility

Various options that render the FCX-AIII suitable for almost any process applications include:

- Full range of hazardous area approvals
- Built-in RFI filter and lightning arrester
- 5-digit LCD meter with engineering unit

### 5. Burnout current flexibility (Under Scale: 3.2 to 4.0mA, Over Scale: 20.0 to 22.5mA)

Burnout signal level is adjustable using Model FXW Hand Held Communicator (HHC) to comply with NAMUR NE43.

### 6. Dry calibration without reference pressure

Thanks to the best combination of unique construction of mechanical parts (Sensor unit) and high performance electronics circuit (Electronics unit), reliability of dry calibration without reference pressure is at equal level as wet calibration.



## SPECIFICATIONS

### Functional specifications

**Service:** Liquid, gas, or vapour

**Span, range and overrange limit:**

Type	Span limit [kPa] {bar}		Range limit [kPa] {bar}	Overrange limit [MPa] {bar}
	Min.	Max.		
FKP □ 01	8.125 {0.08125}	130 {1.3}	-100 to +130 {-1 to +1.3}	1 {10}
FKP □ 02	31.25 {0.3125}	500 {5}	-100 to +500 {-1 to +5}	1.5 {15}
FKP □ 03	187.5 {1.875}	3000 {30}	-100 to +3000 {-1 to +30}	9 {90}
FKP □ 04	625 {6.25}	10000 {100}	-100 to +10000 {-1 to +100}	15 {150}

— Lower range limit (vacuum limit) is;

Silicone fill sensor: See Fig. 1

Fluorinated fill sensor: 66kPa abs (500mmHg abs) at below 60°C

**Output signal:** 4 to 20mA DC with digital signal superimposed on the 4 to 20mA signal.

**Power supply:** Transmitter operates on 10.5V to 45V DC at transmitter terminals.  
10.5V to 32V DC for the units with optional arrester.

**Load limitations:** see figure below

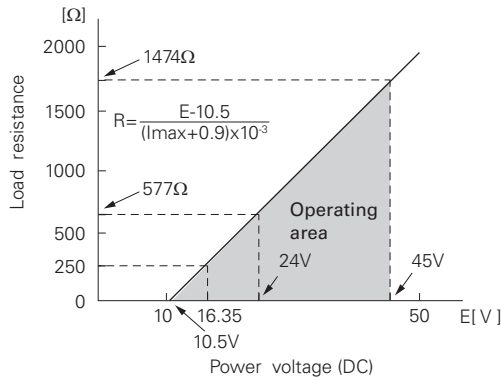

Note: For communication with HHC<sup>(1)</sup> (Model: FXW), min. of 250 Ω required.

**Hazardous locations:** SEE TABLE3

**Zero/span adjustment:**

Zero and span are adjustable from the HHC<sup>(1)</sup>. Zero and span are also adjustable externally from the adjustment screw.

**Damping:** Adjustable from HHC or local configurator unit with LCD display.

The time constant is adjustable between 0.06 to 32 seconds.

**Zero elevation/suppression:**

Zero can be elevated or suppressed within the specified range limit of each sensor model.

**Normal/reverse action:**

Selectable from HHC<sup>(1)</sup>.

**Indication:** Analog indicator or 5-digit LCD meter, as specified.

**Burnout direction:** Selectable from HHC<sup>(1)</sup>

If self-diagnostic detect transmitter failure, the analog signal will be driven to either "Output Hold", "Output Overscale" or "Output Underscale" modes.

"Output Hold":

Output signal is hold as the value just before failure happens.

"Output Overscale":

Adjustable within the range 20.0mA to 22.5mA from HHC<sup>(1)</sup>

"Output Underscale":

Adjustable within the range 3.2mA to 4.0mA from HHC

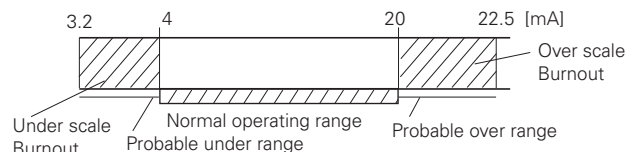

Output limits conforming to NAMUR NE43 by order.

**Loop-check output:**

Transmitter can be configured to provide constant signal 3.2mA through 22.5mA by HHC.

**Temperature limit:**

Ambient: -40 to +85°C

(-20 to +80°C for LCD indicator)

(-40 to +60°C for arrester option)

(-10 to +60°C for fluorinated oil fill transmitter)

For explosionproof units (flameproof or intrinsic safety), ambient temperature must be within the limits specified by each standard.

Process: -40 to +100°C for silicone fill sensor

-20 to +80°C for fluorinated oil fill sensor

Storage: -40 to +90°C

**Humidity limit:** 0 to 100% RH

**Communication:** With HHC<sup>(1)</sup> (Model FXW, consult Data Sheet No. EDS8-47), following items can be remotely displayed or configured.

Note: HHC's version must be higher than 7.0 (or FXW □□□□1-□4), for FCX-AIII.

**Local configurator with LCD display (option):**

Local configurator with 3 push button and LCD display can support following items.

Items	By communication with FXW		By local configurator (with 3 push button)	
	Display	Set	Display	Set
Tag No.	✓	✓	✓	✓
Model No.	✓	✓	✓	✓
Serial No. & Software Version	✓	—	✓	—
Engineering unit	✓	✓	✓	✓
Range limit	✓	—	✓	—
Measuring range	✓	✓	✓	✓
Damping	✓	✓	✓	✓
Output mode	✓	—	✓	—
Burnout direction	✓	✓	✓	✓
Calibration	✓	✓	✓	✓
Output adjust	—	✓	—	✓
Data	✓	—	✓	—
Self diagnoses	✓	—	✓	—
Printer (In case of FXW with printer option)	✓	—	—	—
External switch lock	✓	✓	✓	✓
Transmitter display	✓	✓	✓	✓
Linearize	✓	✓	—	—
Rerange	✓	✓	✓	✓
Saturate current	✓	✓	✓	✓
Write protect	✓	✓	✓	✓
History				
- Calibration history	✓	✓	✓	✓
- Ambient temperature history	✓	—	✓	—

EMC Conformity: EN61326-1: 2006 CE

(Note) (1) HHC: Hand Held Communicator

## Performance specifications

**Accuracy rating:** (including linearity, hysteresis, and repeatability)

For spans greater than 1/10 of URL:

±0.1% of span

For spans below 1/10 of URL :

± (0.05 + 0.05  $\frac{0.1 \times \text{URL}}{\text{span}}$ ) % of span

**Stability:** ±0.2% of upper range limit (URL) for 10 years (In case of 6th digit code "2", "3", "4")

**Temperature effect:** Effects per 55°C change between the limits of – 40°C and +85°C

Zero shift :

± (0.4 + 0.1  $\frac{\text{URL}}{\text{span}}$ )%/28°C

Total effect:

± (0.475 + 0.1  $\frac{\text{URL}}{\text{span}}$ )%/28°C

**Overrange effect:** Zero shift, 0.3% of URL for any overrange to maximum limit

**Supply voltage effect:**

Less than 0.05% of calibrated span per 10V

**Update rate:** 60 msec

**Step response:** Time constant: 0.08s (at 23°C)

Dead time: about 0.12s

(without electrical damping)

**Mounting position effect:**

Zero shift, less than 0.1kPa {1mbar} for a 10° tilt in any plane.

No effect on span. This error can be corrected by adjusting zero.

(Double the effect for fluorinated fill sensors)

**Dielectric strength:**

500V AC, 50/60Hz 1 min., between circuit and earth

**Insulation resistance:**

More than 100MΩ at 500V DC

**Internal resistance for external field indicator:**

12Ω or less.

## Physical specifications

**Electrical connections:**

G1/2, 1/2-14 NPT, Pg13.5, or M20×1.5 conduit, as specified.

**Process connections:**

1/2-14NPT, Rc1/2, Rc1/4 or 1/4-18NPT, as specified.

**Process-wetted parts material:**

symbols)	Diaphragm	Wetted sensor body
V	316 stainless steel	316L stainless steel

**Non-wetted parts material:**

Electronics housing: Low copper die-cast aluminum alloy (standard), finished with polyester coating.

Fill fluid: Silicone oil (standard) or fluorinated oil (Daifloil)

Mounting bracket: 304 stainless steel

**Environmental protection:**

IEC IP67 and NEMA 6/6P

**Mounting:**

On 60.5mm (JIS 50A or 2B) pipe using mounting bracket, direct wall mounting, or direct process mounting.

**Mass(weight):**

Transmitter approximately 2.2kg without options.

Add; 0.5kg for mounting bracket

## Optional features

- Indicator:** A plug-in turnable analog indicator (2.5% accuracy)  
An optional 5digits LCD meter with engineering unit is also available.
- Local configurator with LCD display:**  
An optional 5 digits LCD meter with 3 push buttons can support items as using communication with FXW.
- Arrester:** A built-in arrester protects the electronics from lightning surges.  
Lightning surge immunity:  
4kV (1.2 x 50  $\mu$ s)
- Oxygen service:** Special cleaning procedures are followed throughout the process to maintain all process wetted parts oil-free.  
The fill fluid is fluorinated oil.
- Degreasing:** Process-wetted parts are cleaned, but the fill fluid is standard silicone oil. Not for use for oxygen or chlorine measurement.
- NACE specification:**  
Metallic materials for all pressure boundary parts comply with NACE MR-01-75.
- Optional tag plate:**  
An extra stainless steel tag with customer tag data is wired to the transmitter.

## ACCESSORIES

- Hand-held communicator:**  
(Model FXW, refer to Data Sheet No. EDS8-47)

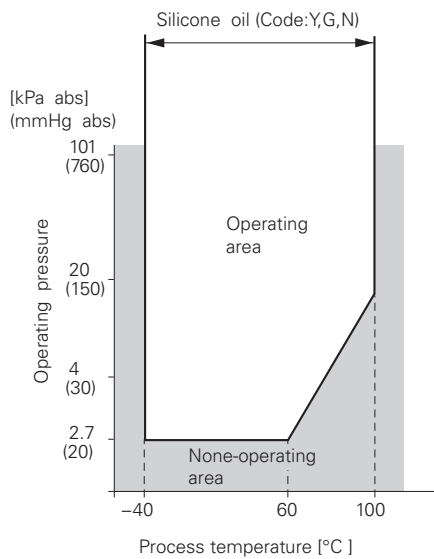

Fig. 1 Relation between process temperature and operating pressure

# CODE SYMBOLS

Digit	Description	Note	Digit No. of code																		
			1	2	3	4	5	6	7	8	9	10	11	12	13	14	15	21			
4	<Connections>		F	K	P	0	5														
	Process connection	Conduit connection																			
	1/2-14NPT	G1/2				5															
	1/2-14NPT	1/2-14NPT				6															
	1/2-14NPT	Pg13.5				7															
	1/2-14NPT	M20×1.5				8															
6	<Span limit> FKP kPa {bar}																				
	8.125 ... 130 {0.08125 ... 1.3}																				
	31.25 ... 500 {0.3125 ... 5}																				
	187.5 ... 3000 {1.875 ... 30}																				
	625 ... 10000 {6.25 ... 100}																				
7	<Material>																				
	Process cover	Diaphragm	Wetted cell body																		
	316 stainless steel	316L stainless steel	316 stainless steel																		
9	<Indicator and arrester>																				
	Indicator	Arrester																			
	None	None																			
	Analog, 0 to 100% linear scale	None																			
	Analog, custom scale	None																			
	None	Yes																			
	Analog, 0 to 100% linear scale	Yes																			
	Analog, custom scale	Yes																			
	Digital, 0 to 100% linear scale	None																			
	Digital, custom scale	None																			
	Digital, 0 to 100% linear scale	Yes																			
	Digital, custom scale	Yes																			
	Digital, 0 to 100% linear scale (Local configurator unit with LCD display)	None																			
	Digital, Custom scale (Local configurator unit with LCD display)	None																			
	Digital, 0 to 100% linear scale (Local configurator unit with LCD display)	Yes																			
Digital, Custom scale (Local configurator unit with LCD display)	Yes																				
10	<Approvals for hazardous locations>																				
	None (for ordinary locations)																				
	TIIS, Flameproof (Cable gland seal) (*1)		Note 1																		
	TIIS, Intrinsic safety																				
	FM, Flameproof (or explosionproof) (*4)		Note 4																		
	FM, Intrinsic safety and nonincendive																				
	FM Combined of flameproof and intrinsic safety (*4)		Note 4																		
	ATEX Flameproof (*3)		Note 3																		
	ATEX Intrinsic safety																				
	ATEX Type n																				
	ATEX Combined of flameproof and intrinsic safety (*3)		Note 3																		
	IECEX Scheme, Flameproof (*3)		Note 3																		
	IECEX Scheme, Intrinsic safety																				
CSA, Flameproof (or explosionproof) (*4)		Note 4																			
CSA, Intrinsic safety and nonincendive																					
NEPSI, Flameproof (or explosionproof)																					
NEPSI, Intrinsic safety																					
NEPSI, Combined of flameproof and intrinsic safety																					
11	<Mounting bracket>																				
	None																				
	Yes (stainless steel)																				
12	<Optional specification>																				
	Stainless tag																				
	None } (*5)																				
	Yes }																				
13	<Special application and fill fluid>																				
	Treatment	Filled liquid																			
	None (standard)	Silicon oil																			
	Degreasing	Silicon oil																			
	Oxygen service	Fluorinated oil																			
NACE specification	Silicon oil																				
15	<Process adaptor>																				
	None (1/2 -14NPT)																				
	Rc1/4																				
	Rc1/2																				
	1/4-18NPT																				
21	<Other options> (*6)																				
	Instruction manual unattached		Note 6																		

Note1: (\*1) Available for 4th digit code "5".

Note3: (\*3) Available for 4th digit code "6", "8".

Note4: (\*4) Available for 4th digit code "6".

Note5: (\*5) Customer tag number can be engraved on standard stainless steel name plate. If extra tag plate is required select "Yes".

Note6: (\*6) If other option is not necessary, 21st digit code is blank. In case of 21st digit code is blank, instruction manual attached.

# OUTLINE DIAGRAM (Unit:mm)

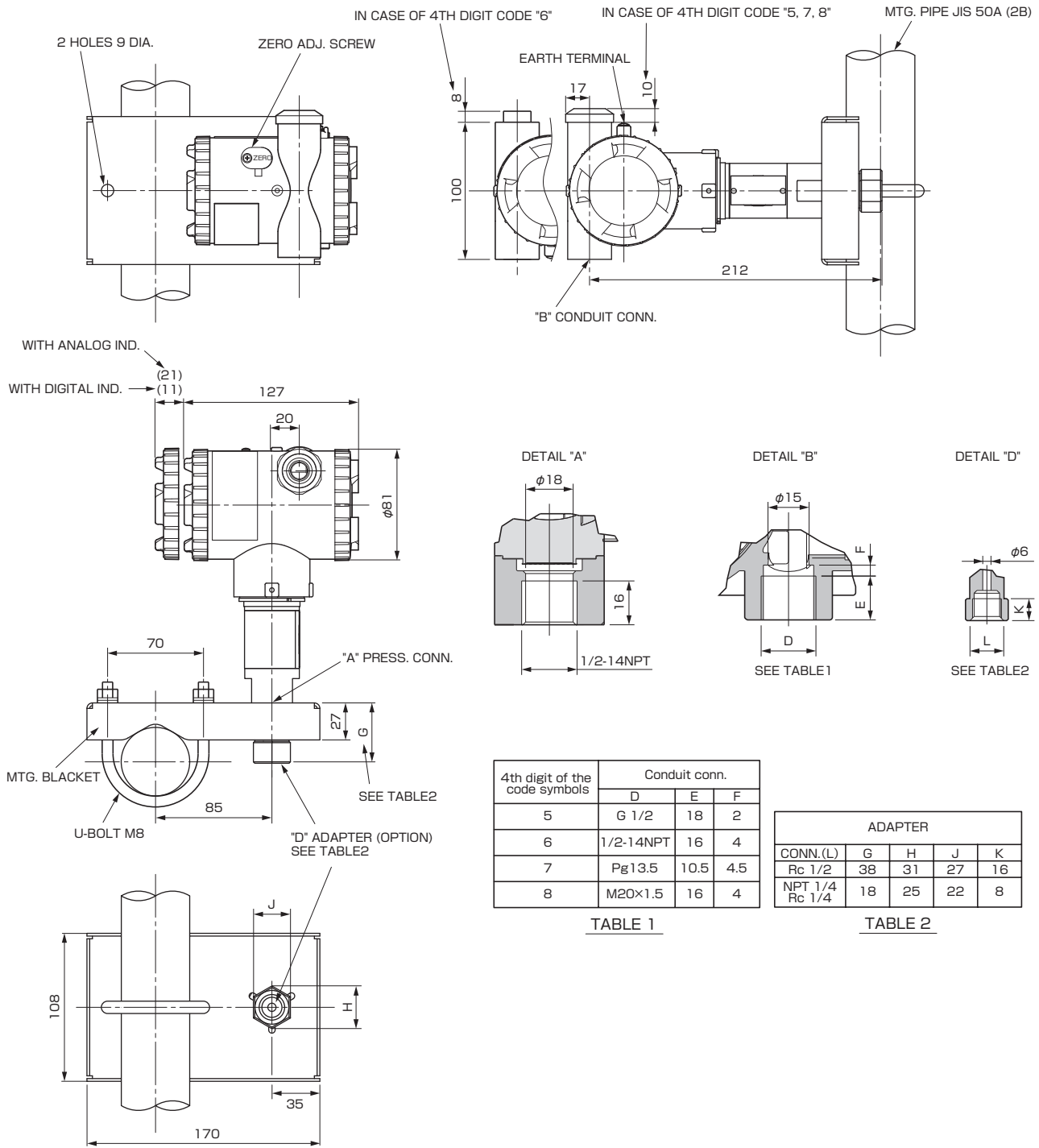

4th digit of the code symbols	Conduit conn.		
	D	E	F
5	G 1/2	18	2
6	1/2-14NPT	16	4
7	Pg13.5	10.5	4.5
8	M20x1.5	16	4

TABLE 1

ADAPTER				
CONN.(L)	G	H	J	K
Rc 1/2	38	31	27	16
NPT 1/4 Rc 1/4	18	25	22	8

TABLE 2

## CONNECTION DIAGRAM

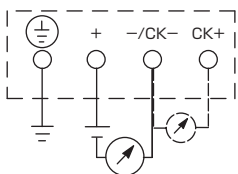

## <SS TAG PLATE>

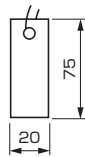

## OPTION PARTS FOR FLAMEPROOF OF TIIS (JAPAN)

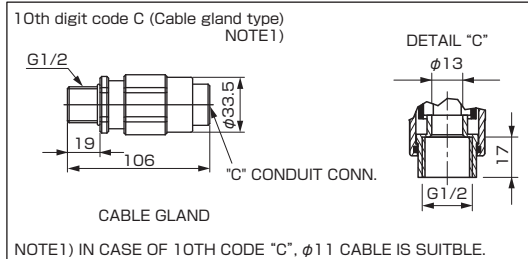

NOTE1) IN CASE OF 10TH CODE "C", φ11 CABLE IS SUITBLE.

TABLE 3

Authorities	Intrinsic safety																				
ATEX	<p>Ex II 1 G                      Ex ia IIC T5 Tamb = -40°C to +50°C                      Ex ia IIC T4 Tamb = -40°C to +70°C</p> <p>Entity Parameters:                      Ui=28V, li=94.3mA, Pi=0.66W,                      Ci=26nF (Without Arrester), Li=0.6mH (Without analog indicator),                      Ci=36nF (With Arrester), Li=0.7mH (With analog indicator)</p>																				
Factory Mutual	<p>Class I II III                      Div.1 Groups A, B, C, D, E, F, G                      T4 Entity Type 4X</p> <table border="1"> <thead> <tr> <th colspan="2">Model code</th> <th rowspan="2">Tamb</th> </tr> <tr> <th>9th digit</th> <th>13th digit</th> </tr> </thead> <tbody> <tr> <td>A,B,D</td> <td>Y,G,N</td> <td>-40°C to +85°C</td> </tr> <tr> <td>L,P,1,2</td> <td>Y,G,N</td> <td>-20°C to +80°C</td> </tr> <tr> <td>Q,S,4,5</td> <td>Y,G,N</td> <td>-20°C to +60°C</td> </tr> <tr> <td>E,F,H</td> <td>Y,G,N</td> <td>-40°C to +60°C</td> </tr> <tr> <td>-</td> <td>A</td> <td>-10°C to +60°C</td> </tr> </tbody> </table> <p>Entity Parameters:                      Vmax=28V, Imax=94.3mA, Pi=0.66W,                      Ci=35.98nF, Li=0.694mH</p>	Model code		Tamb	9th digit	13th digit	A,B,D	Y,G,N	-40°C to +85°C	L,P,1,2	Y,G,N	-20°C to +80°C	Q,S,4,5	Y,G,N	-20°C to +60°C	E,F,H	Y,G,N	-40°C to +60°C	-	A	-10°C to +60°C
Model code		Tamb																			
9th digit	13th digit																				
A,B,D	Y,G,N	-40°C to +85°C																			
L,P,1,2	Y,G,N	-20°C to +80°C																			
Q,S,4,5	Y,G,N	-20°C to +60°C																			
E,F,H	Y,G,N	-40°C to +60°C																			
-	A	-10°C to +60°C																			
CSA	<p>Class I                      Div.1 Groups A, B, C, D                      Class II                      Div.1 Groups E, F, G                      Class III                      Div.1</p> <p>Temp Code T5 Tamb max = +50°C                      Temp Code T4 Tamb max = +70°C</p> <p>Entity Parameters:                      Vmax=28V, Imax=94.3mA, Ci=25nF (Without Arrester),                      Ci=36nF (With Arrester), Li=0.6mH (Without analog meter),                      Li=0.7mH (With analog meter)</p>																				
TIIS	<p>Ex ia IIC T4                      Tamb max = +60°C</p> <p>Entity Parameters:                      Ui=28V, li=94.3mA, Pi=0.66W,                      Ci=38.4nF, Li=0.694mH</p>																				
IECEX Scheme	<p>Ex ia IIC T4                      Tamb = -40°C to +70°C                      Ex ia IIC T5                      Tamb = -40°C to +50°C</p> <p>Entity Parameters:                      Ui=28V, li=94.3mA, Pi=0.66W,                      Ci=26nF (Without Arrester), Li=0.6mH (Without analog indicator),                      Ci=36nF (With Arrester), Li=0.7mH (With analog indicator)</p>																				
NEPSI	<p>Ex ia IIC T4                      Ex d IIB+H<sub>2</sub> T6 / Ex ia IIC T4</p> <table border="1"> <thead> <tr> <th colspan="2">Model code</th> <th rowspan="2">Tamb</th> </tr> <tr> <th>9th digit</th> <th>13th digit</th> </tr> </thead> <tbody> <tr> <td>A,B,D</td> <td>Y,G,N</td> <td>-40°C to +85°C</td> </tr> <tr> <td>L,P,1,2</td> <td>Y,G,N</td> <td>-20°C to +80°C</td> </tr> <tr> <td>Q,S,4,5</td> <td>Y,G,N</td> <td>-20°C to +60°C</td> </tr> <tr> <td>E,F,H</td> <td>Y,G,N</td> <td>-40°C to +60°C</td> </tr> <tr> <td>-</td> <td>A</td> <td>-10°C to +60°C</td> </tr> </tbody> </table> <p>Entity Parameters:                      Ui=42.4V, li=113mA, Pi=1W,                      Ci=35.98nF, Li=0.694mH</p>	Model code		Tamb	9th digit	13th digit	A,B,D	Y,G,N	-40°C to +85°C	L,P,1,2	Y,G,N	-20°C to +80°C	Q,S,4,5	Y,G,N	-20°C to +60°C	E,F,H	Y,G,N	-40°C to +60°C	-	A	-10°C to +60°C
Model code		Tamb																			
9th digit	13th digit																				
A,B,D	Y,G,N	-40°C to +85°C																			
L,P,1,2	Y,G,N	-20°C to +80°C																			
Q,S,4,5	Y,G,N	-20°C to +60°C																			
E,F,H	Y,G,N	-40°C to +60°C																			
-	A	-10°C to +60°C																			

Authorities	Flameproof																				
ATEX	<p>Ex II 2 GD                      Ex d IIC T6 IP66/67 T85°C                      Tamb = -40°C to +65°C                      Ex d IIC T5 IP66/67 T100°C                      Tamb = -40°C to +85°C</p>																				
Factory Mutual	<p>Class I                      Div.1 Groups B, C, D                      T6 Type 4X                      Class II III                      Div.1 Groups E, F, G                      T6 Type 4X                      Tamb max = +60°C</p>																				
CSA	<p>Class I                      Div.1 Groups C, D                      Class II                      Div.1 Groups E, F, G                      Class III                      Div.1</p> <p>Note) "Seal Not Required" enclosure is allowed.</p>																				
IECEX Scheme	<p>Ex d IIC T5 IP66/67                      Tamb = -40°C to +85°C                      Ex d IIC T6 IP66/67                      Tamb = -40°C to +65°C</p>																				
TIIS	<p>Ex do IIB+H<sub>2</sub> T4                      Tamb max = +60°C                      Maximum process temp. = +120°C</p>																				
NEPSI	<p>Ex d IIB+H<sub>2</sub> T6                      Tamb = -40°C to +60°C</p>																				
Authorities	Type n Nonincendive																				
ATEX	<p>Ex II 3 GD                      EEx nL IIC T5 Tamb = -40°C to +50°C                      EEx nL IIC T4 Tamb = -40°C to +70°C</p> <p>Specific Parameters:                      Model without arrester:                      Ui=42.4V, li=113mA, Pi=1W,                      Ci=25.18nF, Li=0.694mH                      Model with arrester:                      Ui=32V, li=113mA, Pi=1W,                      Ci=35.98nF, Li=0.694mH</p> <p>EEx nAL IIC T5 Tamb = -40°C to +50°C                      EEx nAL IIC T4 Tamb = -40°C to +70°C</p> <p>Specific Parameters:                      Model without arrester:                      Umax=42.4V, Imax=113mA, Pmax=1W,                      Model with arrester:                      Umax=32V, Imax=113mA, Pmax=1W</p>																				
Factory Mutual (pending)	<p>Class I II III                      Div.2 Groups A, B, C, D, F, G                      T4 Entity Type 4X</p> <table border="1"> <thead> <tr> <th colspan="2">Model code</th> <th rowspan="2">Tamb</th> </tr> <tr> <th>9th digit</th> <th>13th digit</th> </tr> </thead> <tbody> <tr> <td>A,B,D</td> <td>Y,G,N</td> <td>-40°C to +85°C</td> </tr> <tr> <td>L,P,1,2</td> <td>Y,G,N</td> <td>-20°C to +80°C</td> </tr> <tr> <td>Q,S,4,5</td> <td>Y,G,N</td> <td>-20°C to +60°C</td> </tr> <tr> <td>E,F,H</td> <td>Y,G,N</td> <td>-40°C to +60°C</td> </tr> <tr> <td>-</td> <td>A</td> <td>-10°C to +60°C</td> </tr> </tbody> </table>	Model code		Tamb	9th digit	13th digit	A,B,D	Y,G,N	-40°C to +85°C	L,P,1,2	Y,G,N	-20°C to +80°C	Q,S,4,5	Y,G,N	-20°C to +60°C	E,F,H	Y,G,N	-40°C to +60°C	-	A	-10°C to +60°C
Model code		Tamb																			
9th digit	13th digit																				
A,B,D	Y,G,N	-40°C to +85°C																			
L,P,1,2	Y,G,N	-20°C to +80°C																			
Q,S,4,5	Y,G,N	-20°C to +60°C																			
E,F,H	Y,G,N	-40°C to +60°C																			
-	A	-10°C to +60°C																			
CSA	<p>Class I                      Div.2 Groups A, B, C, D                      Class II                      Div.2 Groups E, F, G                      Class III                      Div.2</p> <p>Temp Code T5 Tamb max = +50°C                      Temp Code T4 Tamb max = +70°C</p> <p>Entity Parameters:                      Vmax=28V, Ci=25.18nF (Without Arrester),                      Ci=35.98nF (With Arrester), Li=0.694mH</p>																				

⚠ Caution on Safety

\*Before using this product, be sure to read its instruction manual in advance.

---

## **Fuji Electric Co., Ltd.**

**International Sales Div  
Sales Group**

Gate City Ohsaki, East Tower, 11-2, Osaki 1-chome,  
Shinagawa-ku, Tokyo 141-0032, Japan

<http://www.fujielectric.com>

Phone: 81-3-5435-7280, 7281 Fax: 81-3-5435-7425

<http://www.fujielectric.com/products/instruments/>