

- > **Soft-Start/Stop Controller and SSR in One Package**
- > **Microcontroller Based Technology**
- > **Adjustable Ramp Rates**
- > **Low Voltage, 4-20mA, or Potentiometer Control**
- > **LED Status Indicator**
- > **SCR Based Output Load Switching**
- > **Built-In Internal Snubber**



### GENERAL SPECIFICATIONS

Dielectric Strength 50/60Hz, Input/Output/Base	4000 Vrms
Insulation Resistance (Min.) @ 500 Vdc	10 <sup>9</sup> Ohm
Max. Capacitance Input/Output	10 pF
Ambient Operating Temperature Range	-20 to 80°C
Ambient Storage Temperature Range	-40 to 125°C

### MECHANICAL SPECIFICATIONS

Weight: (typical)	3.0 oz. (86.5g)
Encapsulation	Thermally Conductive Epoxy
Terminals - Power	Screws and Saddle Clamps Furnished, Unmounted
Control	Barrier Strip Screw Terminals

### OUTPUT SPECIFICATIONS

	Voltage Suffix		
	12	24	48
Operating Voltage (47-63 Hz) [Vrms]	48-140	180-280	300-530
Transient Overvoltage [Vpk]	400	600	1200
Max. Off-State Leakage Current @ Rated Voltage [mA]	5	7	12
Power Factor (Min.) with Max. Load	0.5	0.5	0.5
Maximum Voltage Drop (100% On) [Vpk]	1.6	1.6	1.6
Minimum Off-State dv/dt [V/μsec]	200	200	200
	Current Suffix		
	25 Amp	50 Amp	90 Amp
Max. Load Current [Arms]	25	50	90
Min. Load Current (mArms)	150	150	150
Max. Surge Current (16.6ms) [Apk]	250	625	1200
Thermal Resistance Junction to Case (R <sub>θJC</sub> ) [°C/W]	1.02	0.63	0.28
Maximum I <sub>t</sub> for Fusing, (8.3 msec.) [A <sub>s</sub> ]	260	1620	6000
	ST	SP	SS
	Max. Turn-On Time High Level P3	Adjustable	1/2 Cycle
Max. Turn-Off Time High Level P3	1/2 Cycle	Adjustable	Adjustable

### INPUT SPECIFICATIONS\*

	Minimum	Typical	Maximum
DC Voltage Supply Range [Vdc] [P1]	8	12	32
Input Current [mA]	28		30
Control Must Operate Voltage "ON" [Vdc][P3]	5		32
Control Must Release Voltage "OFF" [Vdc][P3]	0		4
Input Current [mA] [P3]	0		2.6
Analog Range Option A [Vdc][P4]	0.5		5
Analog Range Option B [Vdc][P4]	1.25		7
Analog Range Option C [Vdc][P4]	2		10
Analog Range Option D [mA][P4]	4		20
Nominal Input Impedance Option A,B,C [Ohms][P4]		20K	
Nominal Input Impedance Option D [Ohms][P4]		220	

\*Voltages are reference to GND (Ground = 0Vdc) P2

The MCST, MCSP and MCSS series of controls is designed to provide adjustable surge reducing soft-start and soft-stop control for any load which would benefit from a gradual application or shutdown of power, and provide Crydom SSR switching within one package.

The MCS Controls are available with either soft-start, or soft-stop functions separately, or as a combined soft-start/soft-stop control. With adjustable ramp times from 100ms to 10 seconds in two ranges, these controls are ideal for reducing starting current surges in motors, in preventing saturation when switching transformers, or in reducing reverse EMF surges when de-energizing large inductive loads. Incorporating 4000 volt isolation from input to output, the MCS series allows real time adjustment of the ramp rates from a remote source using analog voltage or current control. Once the desired ramp rate is set using the analog input, a simple digital signal applied to the ON/OFF control input will operate the control. The MCS is also available with a built-in potentiometer for use where remote or continuous adjustment is not needed.

#### Part Number Nomenclature

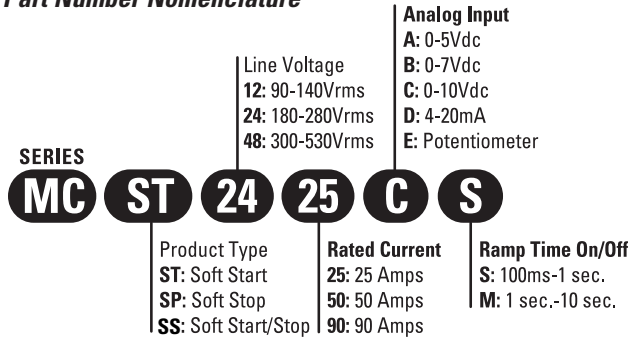

#### Output Status Functions

CONDITIONS	LED
Initial Logic Supply On	Flash Once
Load Voltage Missing / Load Open (w/control P3 disabled)	Flash Once Intermittently
Load Voltage Present (w/control P3 enabled)	Off
Ramp Time (Soft Start upon P3 Enable)	Off to Bright
Ramp Time (Soft Start upon P3 Disable)	Bright to Off
Output ON (Normally Steady Operation)	On

#### Electrical Connections

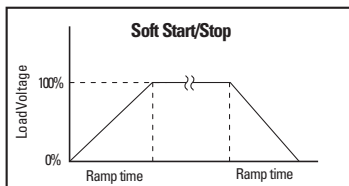
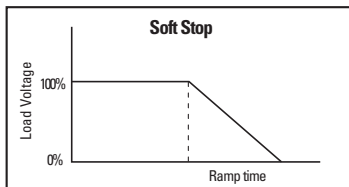
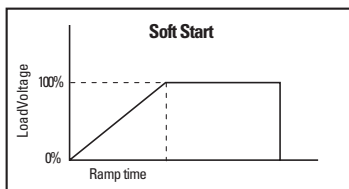
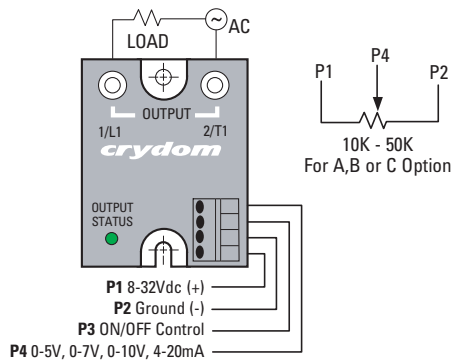

#### Mechanical

Dimensions are in inches (millimeters)

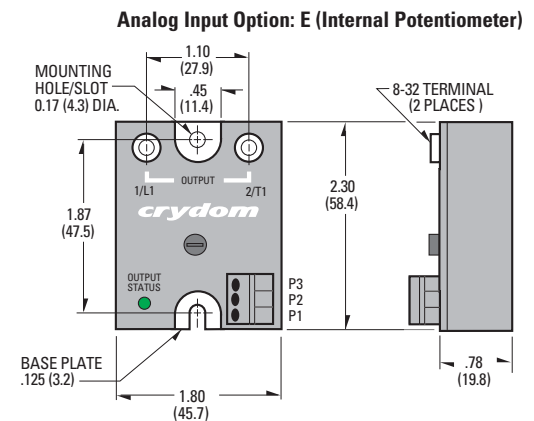
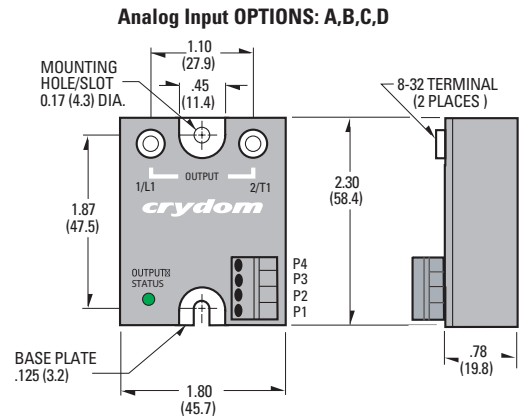

#### Screw Torque Requirements

8-32 Screws - 20in. lbs. (Screws dry without grease.)  
 Input Connections via Screw Type Barrier Strip

### Ramp Time in Seconds

### Current Derating Curves

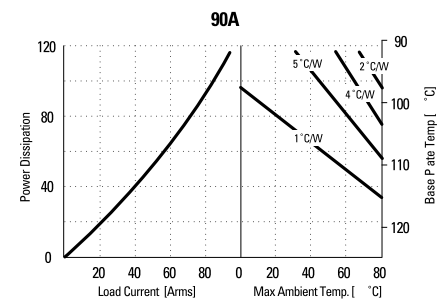
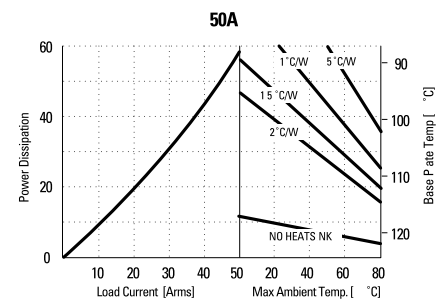
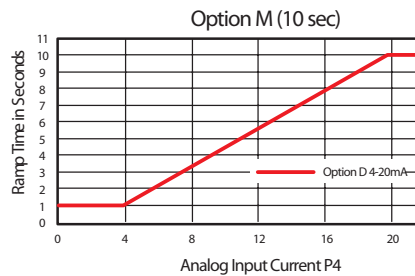
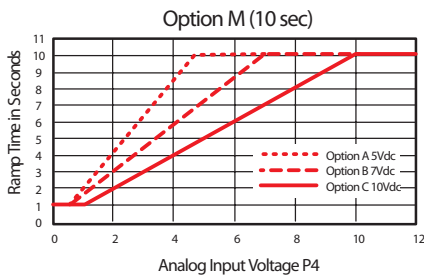
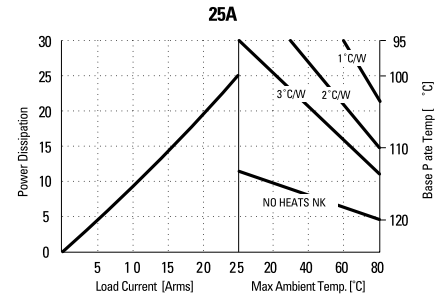
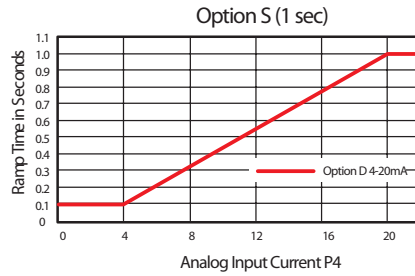
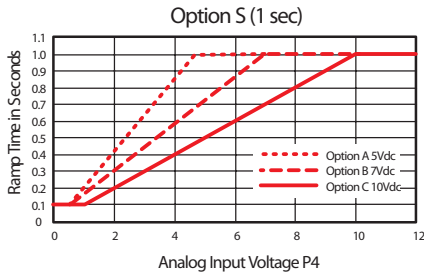

ISO9001 Certified

### Approvals

UL - E116949



For recommended applications and more information contact:  
**USA:** Sales Support (877) 502-5500 **Tech Support** (877) 702-7700 FAX (619) 710-8540  
 Crydom Inc., 2320 Paseo de las Americas, Ste. 201, San Diego, CA 92154  
**Email:** sales@crydom.com **WEB SITE:** http://www.crydom.com  
**UK:** +44 (0)1202 606030 • **FAX** +44 (0)1202 606035 Crydom SSR Ltd., Arena Business Centre,  
 Holyrood Close, Poole, Dorset BH17 7FJ, Email: intsales@crydom.com.  
**GERMANY:** +49 (0)180 3000 506

**DANGER / PELIGRO / DANGER /GEFAHR / PERICOLO / PERIGO**

<p><b>HAZARD OF ELECTRIC SHOCK, EXPLOSION, OR ARC FLASH.</b></p> <ul style="list-style-type: none"> <li>• Disconnect all power before installing or working with this equipment.</li> <li>• Verify all connections and replace all covers before turning on power.</li> </ul> <p><b>Failure to follow these instructions will result in death or serious injury.</b></p>	<p><b>RIESGO DE DESCARGA ELECTRICA O EXPLOSION.</b></p> <ul style="list-style-type: none"> <li>• Desconectar todos los suministros de energia a este equipo antes de trabajar con este equipo.</li> <li>• Verificar todas las conexiones y colocar todas las tapas antes de energizar el equipo.</li> </ul> <p><b>El incumplimiento de estas instrucciones puede provocar la muerte o lesiones serias.</b></p>	<p><b>RISQUE DE DESCARGE ELECTRIQUE OU EXPLOSION</b></p> <ul style="list-style-type: none"> <li>• Eteindre toutes les sources d'énergie de cet appareil avant de travailler dessus de cet appareil</li> <li>• Vérifier tous connections, et remettre tous couverts en place avant de mettre sous</li> </ul> <p><b>De non-suivi de ces instructions provoquera la mort ou des lésions sérieuses.</b></p>	<p><b>GEFAHR EINES ELEKTRISCHEN SCHLAGES ODER EINER EXPLOSION.</b></p> <ul style="list-style-type: none"> <li>• Stellen Sie jeglichen Strom ab, der dieses Gerät versorgt, bevor Sie an dem Gerät Arbeiten durchführen</li> <li>• Vor dem Drehen auf Energie alle Anschlüsse überprüfen und alle Abdeckungen ersetzen.</li> </ul> <p><b>Unterlassung dieser Anweisungen können zum Tode oder zu schweren Verletzungen führen.</b></p>	<p><b>RISCHIO DI SCOSSA ELETTRICA O DELL'ESPLOSIONE.</b></p> <ul style="list-style-type: none"> <li>• Spenga tutta l'alimentazione e che fornisce questa apparecchiatura prima del lavorare a questa apparecchiatura</li> <li>• Verificare tutti i collegamenti e sostituire tutte le coperture prima della rotazione sull'alimentazione</li> </ul> <p><b>L'omissione di seguire queste istruzioni provocherà la morte o di lesioni serie</b></p>	<p><b>RISCO DE DESCARGA ELÉTRICA OU EXPLOÇÃO</b></p> <ul style="list-style-type: none"> <li>• Desconectar o equipamento de toda a energia antes de instalar ou trabalhar com este equipamento</li> <li>• Verificar todas as conexões e recolocar todas as tampas antes de religar o equipamento</li> </ul> <p><b>O não cumprimento destas instruções pode levar a morte ou lesões sérias.</b></p>
--	--	---	---	---	---

**WARNING / AVERTISSEMENT / WARNUNG / ADVERTENCIA / AVVERTENZA / AVISO**

<p><b>RISK OF MATERIAL DAMAGE AND HOT ENCLOSURE</b></p> <ul style="list-style-type: none"> <li>• The product's side panels may be hot, allow time for product to cool before touching.</li> <li>• Follow proper mounting instructions including torque values.</li> <li>• Do not allow liquids or foreign objects to enter this product.</li> </ul> <p><b>Failure to follow this instruction can result in serious injury, or equipment damage.</b></p>	<p><b>RISQUE DE DOMMAGE MATERIEL ET DE SURCHAUFFE DU BOITIER</b></p> <ul style="list-style-type: none"> <li>• Les panneaux latéraux du produit peuvent être chauds. Laisser le produit refroidir avant de le toucher.</li> <li>• Respecter les consignes de montage, et notamment les couples de serrage.</li> <li>• Ne pas laisser pénétrer de liquide ni de corps étrangers à l'intérieur du produit.</li> </ul> <p><b>Le non-respect de cette directive peut entraîner, des lésions corporelles graves ou des dommages matériels.</b></p>	<p><b>GEFAHR VON MATERIALSCHÄDEN UND GEHÄUSEERHITZUNG</b></p> <ul style="list-style-type: none"> <li>• Die Seitenwände können heiß sein. Lassen Sie das Produkt abkühlen, bevor Sie es berühren.</li> <li>• Beachten Sie die Montageanweisungen,</li> <li>• Führen Sie keine Flüssigkeiten oder Fremdkörper in das Produkt ein.</li> </ul> <p><b>Die Nichtbeachtung dieser Anweisung kann Körperverletzung oder Materialschäden zur Folge haben.</b></p>
<p><b>RIESGO DE DAÑOS MATERIALES Y DE SOBRECIENTAMIENTO DE LA UNIDAD</b></p> <ul style="list-style-type: none"> <li>• Los paneles laterales del producto pueden estar calientes. Esperar que el producto se enfríe antes de tocarlo.</li> <li>• Respetar las instrucciones de montaje, y en particular los pares de apretado.</li> <li>• No dejar que penetren líquidos o cuerpos extraños en el producto.</li> </ul> <p><b>Si no se respetan estas precauciones pueden producirse graves lesiones, daños materiales.</b></p>	<p><b>RISCHIO DI DANNI MATERIALI E D'INVOLUCRO CALDO</b></p> <ul style="list-style-type: none"> <li>• I pannelli laterali dell'apparecchio possono scottare; lasciar quindi raffreddare il prodotto prima di toccarlo.</li> <li>• Seguire le istruzioni di montaggio corrette.</li> <li>• Non far entrare liquidi o oggetti estranei in questo apparecchio.</li> </ul> <p><b>La mancata osservanza di questa precauzione può causare gravi rischi per l'incolumità personale o danni alle apparecchiature.</b></p>	<p><b>RISCO DE DANO MATERIAL E DE AQUECIMENTO</b></p> <ul style="list-style-type: none"> <li>• Os painéis laterais do produto podem estar quentes; dê tempo ao produto para arrefecer antes de lhe tocar.</li> <li>• Siga devidamente as instruções de montagem.</li> <li>• Não permita a entrada de líquidos e de objectos estranhos no produto.</li> </ul> <p><b>A não observância destas precauções pode provocar a morte, ferimentos graves ou danos materiais.</b></p>

## ANNEX – ENVIRONMENTAL INFORMATION:

The environmental information disclosed in this annex including the EIP Pollution logo are in compliance with People's Republic of China Electronic Industry Standard SJ/T11364 – 2006, Marking for Control of Pollution Caused by Electronic Information Products.

Part Name	Toxic or hazardous Substance and Elements					
	Lead (Pb)	Mercury (Hg)	Cadmium (Cd)	Hexavalent Chromium (Cr (VI))	Polybrominated biphenyls (PBB)	Polybrominated diphenyl ethers (PBDE)
Semiconductor die	X	O	O	O	O	O
Solder	X	O	O	O	O	O

### 附件 - 环保信息:

此附件所标示的包括电子信息产品污染图标的环保信息符合中华人民共和国电子行业标准 **SJ/T11364 - 2006**, 电子信息产品污染控制标识要求

部件名称	有毒有害物质或元素					
	铅 (Pb)	汞 (Hg)	镉 (Cd)	六价铬 (Cr (VI))	多溴联苯 (PBB)	多溴二苯醚 (PBDE)
半导体芯片	X	O	O	O	O	O
焊接点	X	O	O	O	O	O

