

AEE16 High Frequency Transformers

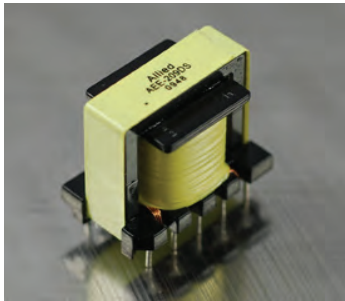

- EE16 Core Design
- Through Hole
- Vertical Mount for Smaller Foot Print
- Flyback Topology
- 3KVrms Hi-pot Rating
- 18mm Max Ht
- Operating Temperature -40°C ~ +130°C

Electrical Specifications @25°C					Schematics	
Part Number	Turn Ratio			Inductance	Leakage Inductance	
AEE16-1931	7-5 : 4-1 : 10-9			7-5 other windings open	7-5 short 1,4	
	22 : 1 : 5			3200uH±10%	56uH max	
	Continue			VAC Hi-Pot (3mA/60s)		
	DCR			pri to sec		
	7-5	4-1	10-9	3000V		
	6400mΩ max	20mΩ max	360mΩ max			
AEE16-2115	2-1 : 3-4 : 5-6 : 10-9			2-1 other windings open	2-1 short 3,4,5,6,9,10	
	18 : 4 : 1 : 1.4			1000uH±15%	40uH max	
	Continue			VAC Hi-Pot (3mA/60s)		
	DCR			pri to sec		
	2-1	3-4	5-6	10-9	3000V	
	3220mΩ max	210mΩ max	70mΩ max	80mΩ max		
AEE16-2517	7-5 : 4-1 : 10-9			7-5 other windings open	7-5 short 1,4,9,10	
	8.5 : 1 : 1.23			1200uH±10%	30uH max	
	Continue			VAC Hi-Pot (3mA/60s)		
	DCR			pri to sec		
	7-5	4-1	10-9	3000V		
	4950mΩ max	57.5mΩ max	915mΩ max			
AEE16-2531	1-4 : 9-6			1-4 other windings open	1-4 short 9,6	
	0.5 : 1			4.5uH±12%	0.21uH max	
	Continue			VAC Hi-Pot (3mA/60s)		
	DCR			pri to sec		
	1-4	9-6		4000V		
	142mΩ max	73mΩ max				
AEE16-2621	5-7 : 4-3 : 2-1 : 9-10			5-7 other windings open	5-7 short 4,3,2,1	
	4.0 : 2.5 : 1 : 2.5			1000uH±10%	17uH max	
	Continue			VAC Hi-Pot (3mA/60s)		
	DCR			pri to sec		
	5-7	4-3	2-1	9-10	4000V	
	2430mΩ max	260mΩ max	82mΩ max	89mΩ max		

AEE16

High Frequency Transformers



AEE16-1931

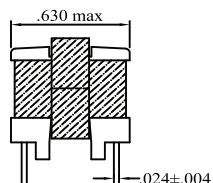
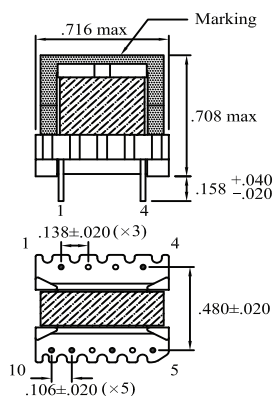

Units : Inch.
Pin 2,3,6,8 cut off.
Marking: AEE16-1931
Allied Date Code

AEE16-2531

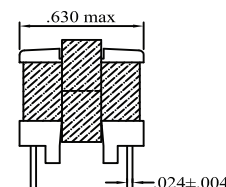
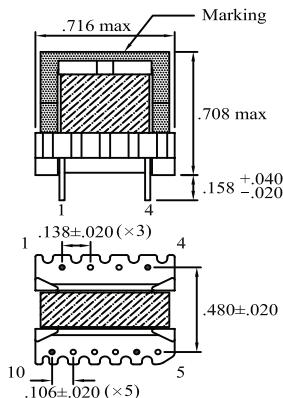

Units : Inch.
Pin 2,3,5,7,8,9 cut off.
Marking: AEE16-2531
Allied Date Code

AEE16-2115

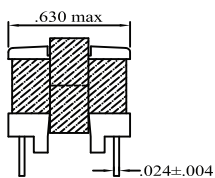
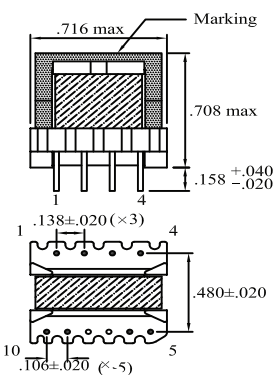

Units : Inch.
Pin 7,8 cut off.
Marking: AEE16-2115
Allied Date Code

AEE16-2621

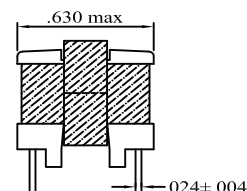
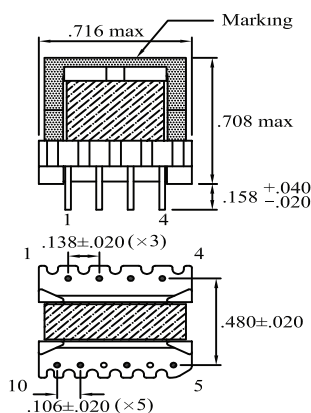

Units : Inch.
Pin 6,8 cut off.
Marking: AEE16-2621
Allied Date Code

AEE16-2517

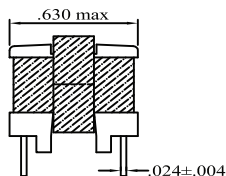
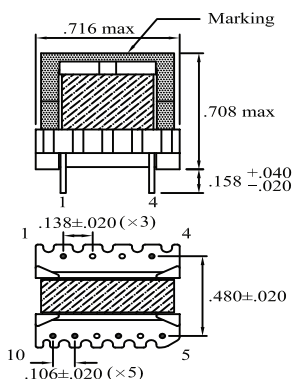

Units : Inch.
Pin 2,3,6,8 cut off.
Marking: AEE16-2517
Allied Date Code