

NTJD4158C

Small Signal MOSFET

30 V/-20 V, +0.25/-0.88 A,
Complementary, SC-88

Features

- Leading 20 V Trench for Low $R_{DS(on)}$ Performance
- ESD Protected Gate
- SC-88 Package for Small Footprint (2 x 2 mm)
- This is a Pb-Free Device

Applications

- DC-DC Conversion
- Load/Power Management
- Load Switch
- Cell Phones, MP3s, Digital Cameras, PDAs

MAXIMUM RATINGS ($T_J = 25^\circ\text{C}$ unless otherwise noted)

Parameter		Symbol	Value	Unit
Drain-to-Source Voltage	N-Ch	V_{DSS}	30	V
	P-Ch		-20	
Gate-to-Source Voltage	N-Ch	V_{GS}	± 20	V
	P-Ch		± 12	
N-Channel Continuous Drain Current (Note 1)	Steady State	$T_A = 25^\circ\text{C}$	0.25	A
		$T_A = 85^\circ\text{C}$	0.18	
P-Channel Continuous Drain Current (Note 1)	Steady State	$T_A = 25^\circ\text{C}$	-0.88	
		$T_A = 85^\circ\text{C}$	-0.63	
Power Dissipation (Note 1)	Steady State	$T_A = 25^\circ\text{C}$	P_D	0.27 W
Pulsed Drain Cur- rent	N-Ch	$t_p = 10 \mu\text{s}$	I_{DM}	0.5 A
	P-Ch			-3.0
Operating Junction and Storage Temperature		T_J, T_{stg}	-55 to 150	$^\circ\text{C}$
Source Current (Body Diode)	N-Ch	I_S	0.25	A
	P-Ch		-0.48	
Lead Temperature for Soldering Purposes (1/8" from case for 10 s)		T_L	260	$^\circ\text{C}$

THERMAL RESISTANCE RATINGS

Parameter	Symbol	Max	Unit
Junction-to-Ambient - Steady State (Note 1)	$R_{\theta JA}$	460	$^\circ\text{C}/\text{W}$

Stresses exceeding Maximum Ratings may damage the device. Maximum Ratings are stress ratings only. Functional operation above the Recommended Operating Conditions is not implied. Extended exposure to stresses above the Recommended Operating Conditions may affect device reliability.

1. Surface mounted on FR4 board using 1 in sq pad size (Cu area = 1.127 in sq [1 oz] including traces).



ON Semiconductor®

<http://onsemi.com>

$V_{(BR)DSS}$	$R_{DS(on)}$ Typ	I_D Max
N-Ch 30 V	1.0 Ω @ 4.5 V	0.25 A
	1.5 Ω @ 2.5 V	
P-Ch -20 V	215 m Ω @ -4.5 V	-0.88 A
	345 m Ω @ -2.5 V	

SC-88 (SOT-363)
(6-Leads)

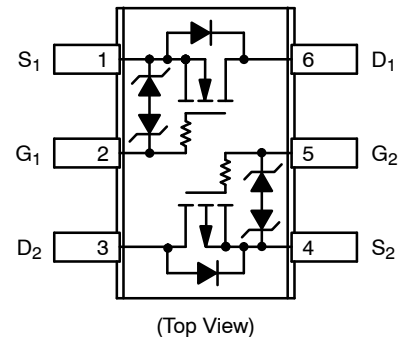

MARKING DIAGRAM & PIN ASSIGNMENT



SC-88 (SOT-363)
CASE 419B
STYLE 26

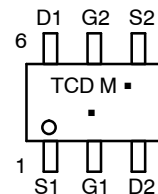

TCD = Specific Device Code
M = Date Code
▪ = Pb-Free Package

(Note: Microdot may be in either location)

ORDERING INFORMATION

Device	Package	Shipping†
NTJD4158CT1G	SC-88 (Pb-Free)	3000 Tape & Reel

†For information on tape and reel specifications, including part orientation and tape sizes, please refer to our Tape and Reel Packaging Specification Brochure, BRD8011/D.

NTJD4158C

ELECTRICAL CHARACTERISTICS (T_J = 25°C unless otherwise noted)

Parameter	Symbol	N/P	Test Condition	Min	Typ	Max	Unit
-----------	--------	-----	----------------	-----	-----	-----	------

OFF CHARACTERISTICS (Note 3)

Drain-to-Source Breakdown Voltage	V _{(BR)DSS}	N	V _{GS} = 0 V	I _D = 250 μA	30			V
		P		I _D = -250 μA	-20			
Drain-to-Source Breakdown Voltage Temperature Coefficient	V _{(BR)DSS} /T _J	N			33			mV/°C
		P			-9.0			
Zero Gate Voltage Drain Current	I _{DSS}	N	V _{GS} = 0 V, V _{DS} = 30 V	T _J = 25°C			1.0	μA
		P	V _{GS} = 0 V, V _{DS} = -16 V				1.0	
		N	V _{GS} = 0 V, V _{DS} = 30 V	T _J = 125°C		0.5		
		P	V _{GS} = 0 V, V _{DS} = -16 V			0.5		
Gate-to-Source Leakage Current	I _{GSS}	N	V _{DS} = 0 V, V _{GS} = 10 V				1.0	μA
		P	V _{DS} = 0 V, V _{GS} = -4.5 V				1.0	

ON CHARACTERISTICS (Note 2)

Gate Threshold Voltage	V _{GS(TH)}	N	V _{GS} = V _{DS}	I _D = 100 μA	0.8	1.2	1.5	V
		P		I _D = -250 μA	-0.45			
Negative Gate Threshold Temperature Coefficient	V _{GS(TH)} /T _J	N				3.2		mV/°C
		P				-2.7		
Drain-to-Source On Resistance	R _{DS(on)}	N	V _{GS} = 4.5 V, I _D = 10 mA			1.0	1.5	Ω
		P	V _{GS} = -4.5 V, I _D = -0.88 A			0.215	0.260	
		N	V _{GS} = 2.5 V, I _D = 10 mA			1.5	2.5	
		P	V _{GS} = -2.5 V, I _D = -0.71 A			0.345	0.500	
Forward Transconductance	g _{FS}	N	V _{DS} = 3.0 V, I _D = 10 mA			0.08		S
		P	V _{DS} = -10 V, I _D = -0.88 A			3.0		

CHARGES, CAPACITANCES AND GATE RESISTANCE

Input Capacitance	C _{ISS}	N	f = 1 MHz, V _{GS} = 0 V	V _{DS} = 5.0 V		20	33	pF	
		P		V _{DS} = -20 V		155	225		
Output Capacitance	C _{OSS}	N		V _{DS} = 5.0 V		19	32		
		P		V _{DS} = -20 V		25	40		
Reverse Transfer Capacitance	C _{RSS}	N		V _{DS} = 5.0 V		7.25	12		
		P		V _{DS} = -20 V		18	30		
Total Gate Charge	Q _{G(TOT)}	N		V _{GS} = 5.0 V, V _{DS} = 24 V, I _D = 0.1 A		0.9	1.5		nC
		P		V _{GS} = -4.5 V, V _{DS} = -10 V, I _D = -0.88 A		2.2	3.5		
Threshold Gate Charge	Q _{G(TH)}	N		V _{GS} = 5.0 V, V _{DS} = 24 V, I _D = 0.1 A		0.2			
		P		V _{GS} = -4.5 V, V _{DS} = -10 V, I _D = -0.88 A		0.2			
Gate-to-Source Charge	Q _{GS}	N		V _{GS} = 5.0 V, V _{DS} = 24 V, I _D = 0.1 A		0.3			
		P		V _{GS} = -4.5 V, V _{DS} = -10 V, I _D = -0.88 A		0.5			
Gate-to-Drain Charge	Q _{GD}	N	V _{GS} = 5.0 V, V _{DS} = 24 V, I _D = 0.1 A		0.2				
		P	V _{GS} = -4.5 V, V _{DS} = -10 V, I _D = -0.88 A		0.65				

SWITCHING CHARACTERISTICS (Note 3)

Turn-On Delay Time	t _{d(ON)}	N	V _{GS} = 4.5 V, V _{DD} = 5.0 V, I _D = 250 mA, R _G = 50 Ω		15		ns	
Rise Time	t _r				66			
Turn-Off Delay Time	t _{d(OFF)}				56			
Fall Time	t _f				78			
Turn-On Delay Time	t _{d(ON)}	P		V _{GS} = -4.5 V, V _{DD} = -10 V, I _D = -0.5 A, R _G = 20 Ω		5.8		
Rise Time	t _r					6.5		
Turn-Off Delay Time	t _{d(OFF)}					13.5		
Fall Time	t _f					3.5		

DRAIN-SOURCE DIODE CHARACTERISTICS

Forward Diode Voltage	V _{SD}	N	V _{GS} = 0 V, T _J = 25°C	I _S = 10 mA	0.65	0.7	V
		P		I _S = -0.48 A	-0.8	-1.2	
		N	V _{GS} = 0 V, T _J = 125°C	I _S = 10 mA	0.45		
		P		I _S = -0.48 A	-0.66		
Reverse Recovery Time	t _{RR}	N	V _{GS} = 0 V, dI _S /dt = 8.0 A/μs	I _S = 10 mA	12.4		ns
		P	V _{GS} = 0 V, dI _S /dt = 100 A/μs	I _S = -0.48 mA	TBD		

2. Pulse Test: pulse width ≤ 300 μs, duty cycle ≤ 2%.

3. Switching characteristics are independent of operating junction temperatures.

NTJD4158C

TYPICAL N-CHANNEL PERFORMANCE CURVES ($T_J = 25^\circ\text{C}$ unless otherwise noted)

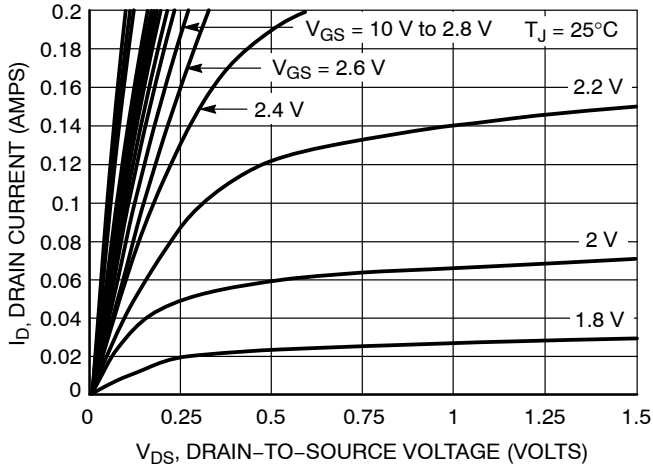

Figure 1. On-Region Characteristics

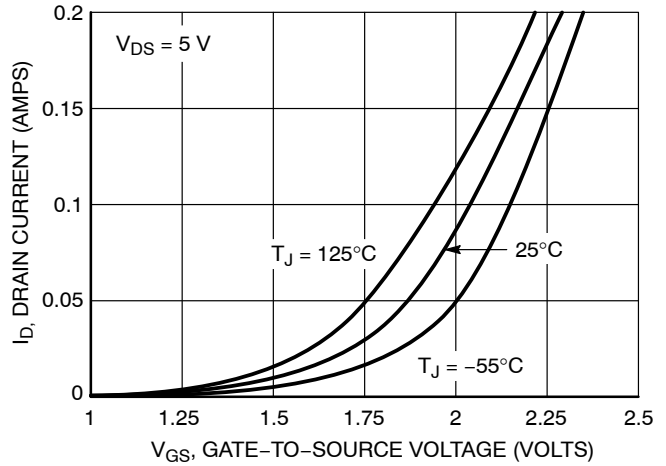

Figure 2. Transfer Characteristics

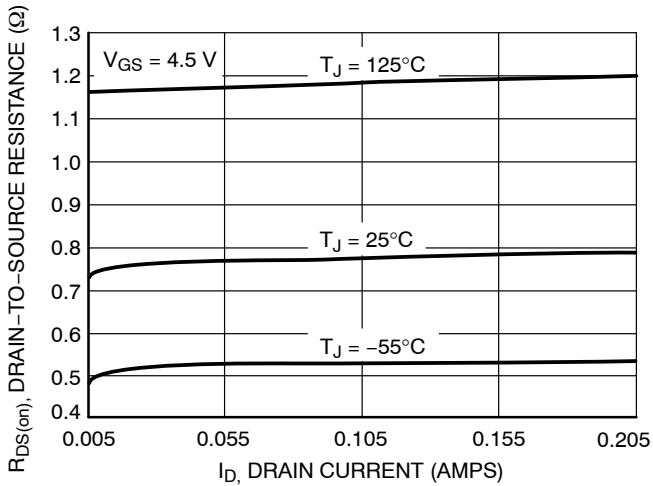

Figure 3. On-Resistance vs. Drain Current and Temperature

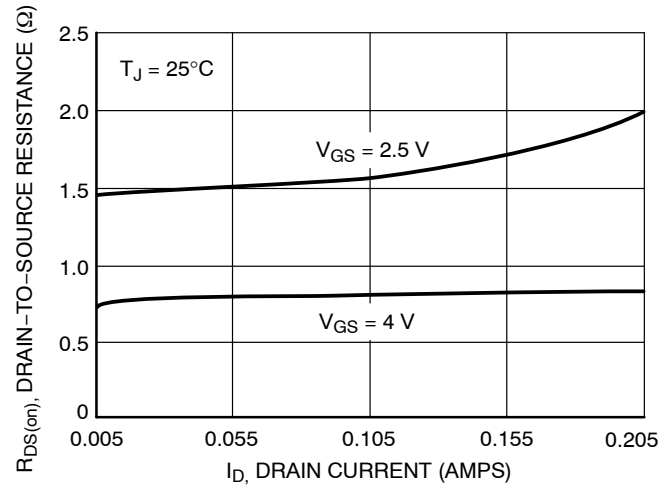

Figure 4. On-Resistance vs. Drain Current and Gate Voltage

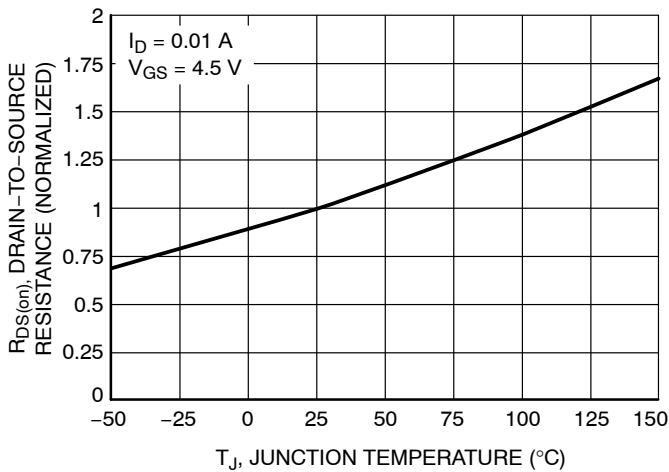

Figure 5. On-Resistance Variation with Temperature

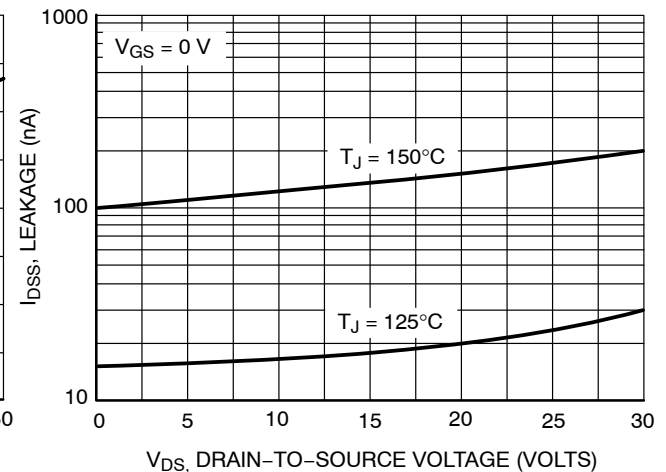

Figure 6. Drain-to-Source Leakage Current vs. Voltage

TYPICAL N-CHANNEL PERFORMANCE CURVES ($T_J = 25^\circ\text{C}$ unless otherwise noted)

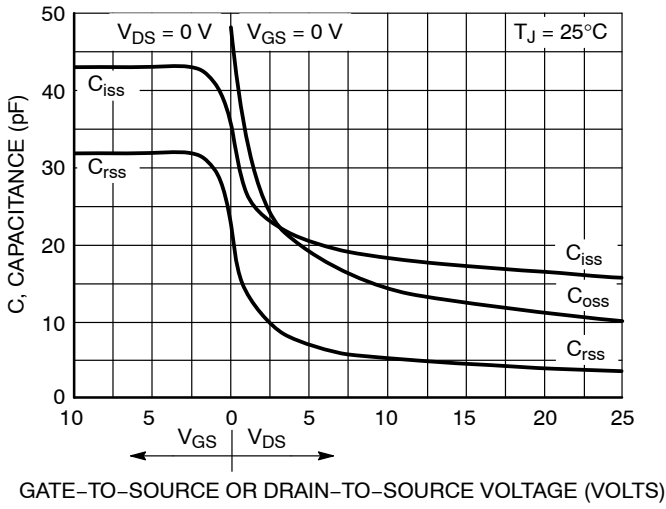

Figure 7. Capacitance Variation

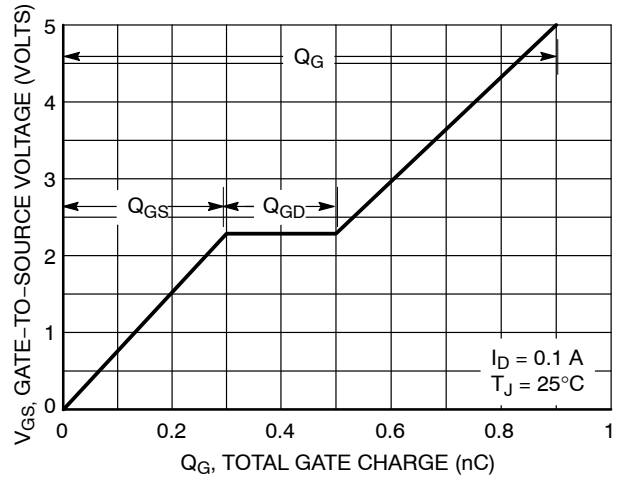

Figure 8. Gate-to-Source Voltage vs. Total Gate Charge

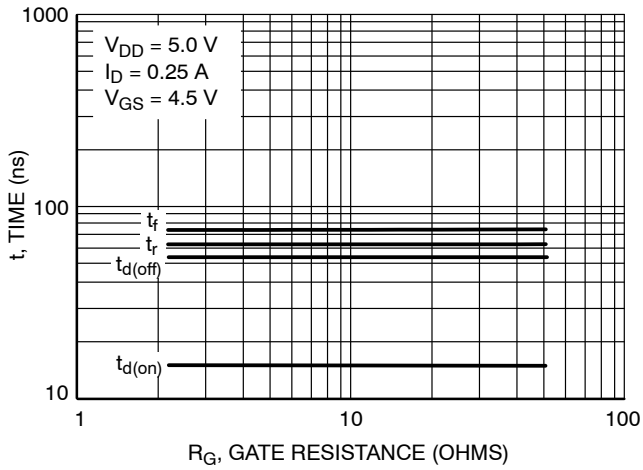

Figure 9. Resistive Switching Time Variation vs. Gate Resistance

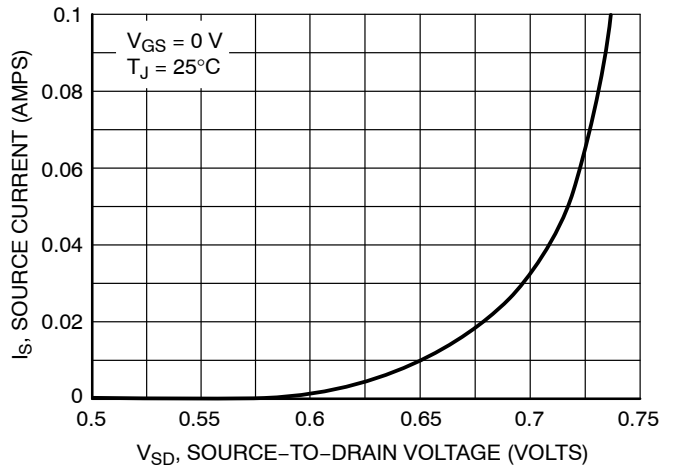

Figure 10. Diode Forward Voltage vs. Current

TYPICAL P-CHANNEL PERFORMANCE CURVES ($T_J = 25^\circ\text{C}$ unless otherwise noted)

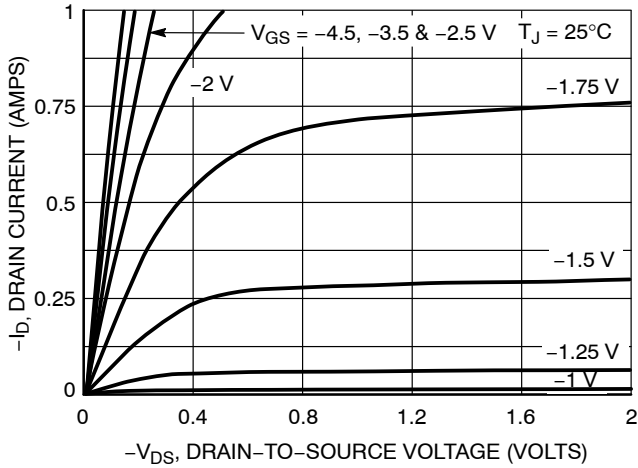

Figure 1. On-Region Characteristics

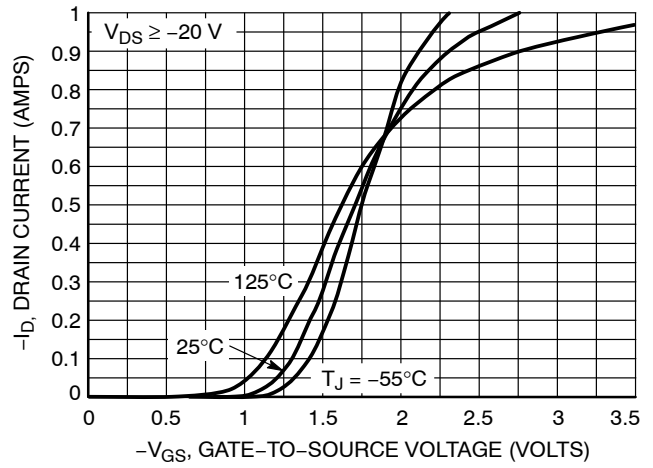

Figure 2. Transfer Characteristics

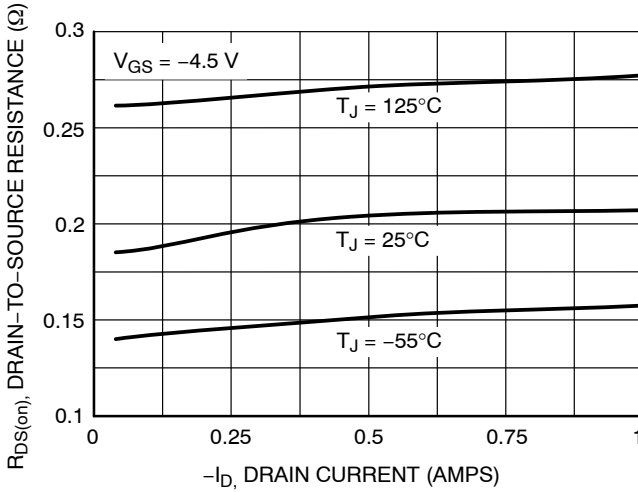

Figure 3. On-Resistance vs. Drain Current and Temperature

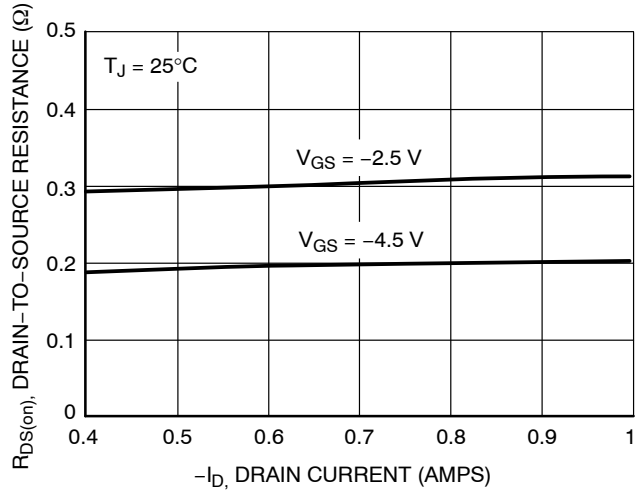

Figure 4. On-Resistance vs. Drain Current and Gate Voltage

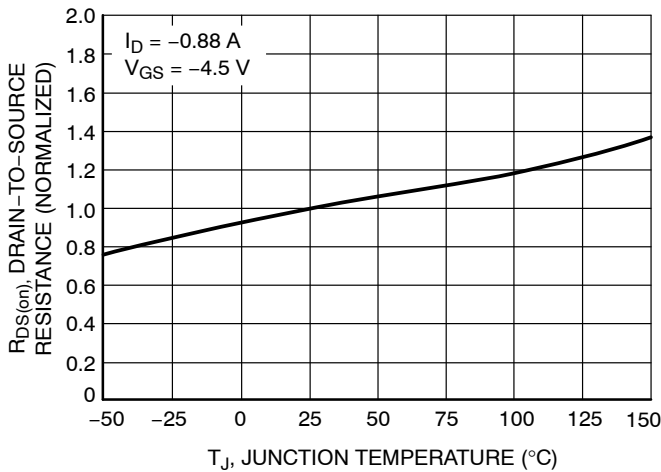

Figure 5. On-Resistance Variation with Temperature

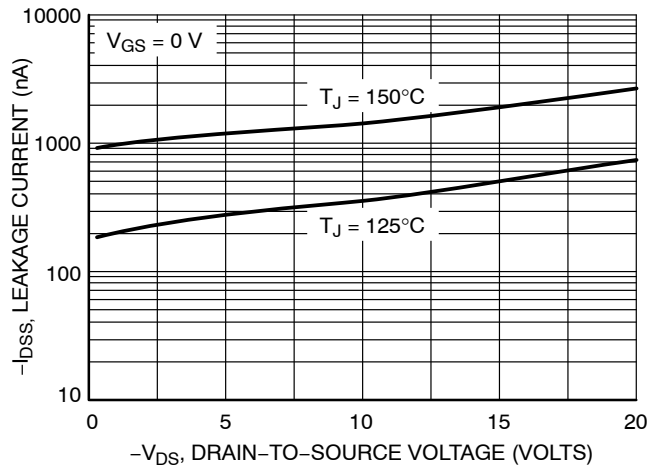

Figure 6. Drain-to-Source Leakage Current vs. Voltage

TYPICAL P-CHANNEL PERFORMANCE CURVES ($T_J = 25^\circ\text{C}$ unless otherwise noted)

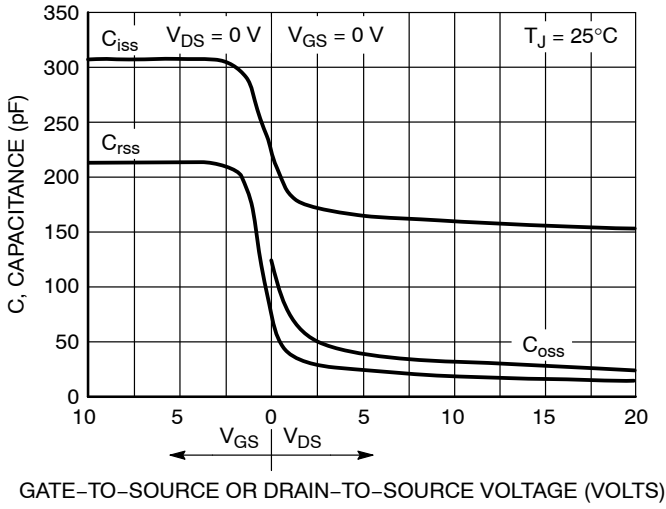

Figure 7. Capacitance Variation

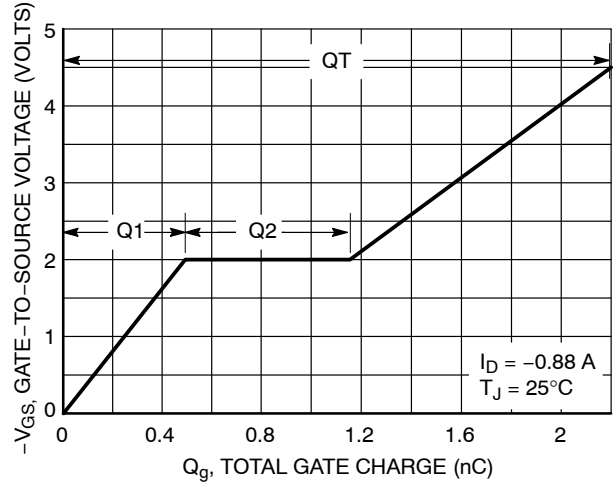

Figure 8. Gate-to-Source Voltage vs. Total Gate Charge

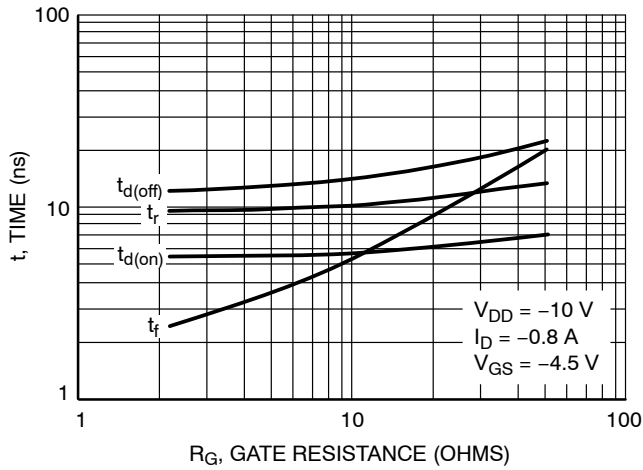

Figure 9. Resistive Switching Time Variation vs. Gate Resistance

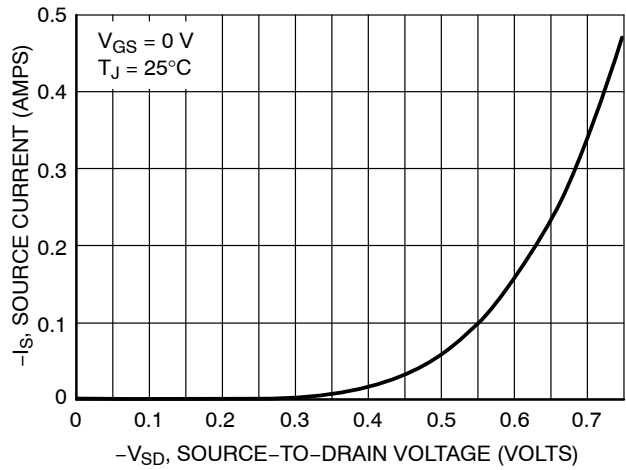
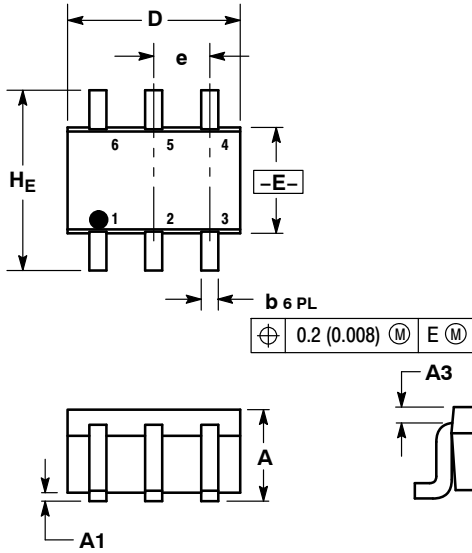

Figure 10. Diode Forward Voltage vs. Current

NTJD4158C

PACKAGE DIMENSIONS

SC-88/SC70-6/SOT-363
CASE 419B-02
ISSUE W



- NOTES:
- DIMENSIONING AND TOLERANCING PER ANSI Y14.5M, 1982.
 - CONTROLLING DIMENSION: INCH.
 - 419B-01 OBSOLETE, NEW STANDARD 419B-02.

DIM	MILLIMETERS			INCHES		
	MIN	NOM	MAX	MIN	NOM	MAX
A	0.80	0.95	1.10	0.031	0.037	0.043
A1	0.00	0.05	0.10	0.000	0.002	0.004
A3	0.20 REF			0.008 REF		
b	0.10	0.21	0.30	0.004	0.008	0.012
C	0.10	0.14	0.25	0.004	0.005	0.010
D	1.80	2.00	2.20	0.070	0.078	0.086
E	1.15	1.25	1.35	0.045	0.049	0.053
e	0.65 BSC			0.026 BSC		
L	0.10	0.20	0.30	0.004	0.008	0.012
HE	2.00	2.10	2.20	0.078	0.082	0.086

STYLE 26:

- PIN 1. SOURCE 1
- GATE 1
- DRAIN 2
- SOURCE 2
- GATE 2
- DRAIN 1

SOLDERING FOOTPRINT*

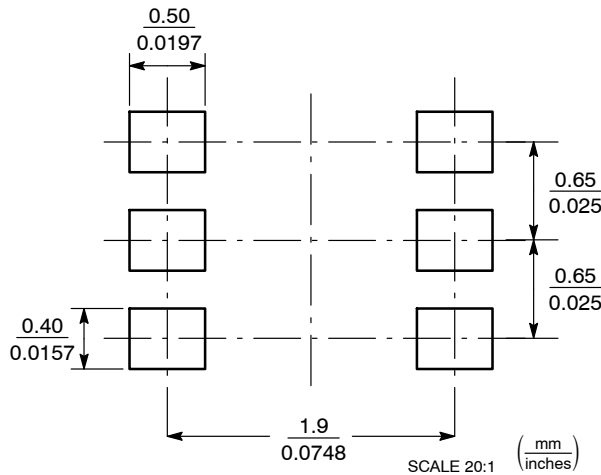

*For additional information on our Pb-Free strategy and soldering details, please download the ON Semiconductor Soldering and Mounting Techniques Reference Manual, SOLDERRM/D.

ON Semiconductor and are registered trademarks of Semiconductor Components Industries, LLC (SCILLC). SCILLC reserves the right to make changes without further notice to any products herein. SCILLC makes no warranty, representation or guarantee regarding the suitability of its products for any particular purpose, nor does SCILLC assume any liability arising out of the application or use of any product or circuit, and specifically disclaims any and all liability, including without limitation special, consequential or incidental damages. "Typical" parameters which may be provided in SCILLC data sheets and/or specifications can and do vary in different applications and actual performance may vary over time. All operating parameters, including "Typicals" must be validated for each customer application by customer's technical experts. SCILLC does not convey any license under its patent rights nor the rights of others. SCILLC products are not designed, intended, or authorized for use as components in systems intended for surgical implant into the body, or other applications intended to support or sustain life, or for any other application in which the failure of the SCILLC product could create a situation where personal injury or death may occur. Should Buyer purchase or use SCILLC products for any such unintended or unauthorized application, Buyer shall indemnify and hold SCILLC and its officers, employees, subsidiaries, affiliates, and distributors harmless against all claims, costs, damages, and expenses, and reasonable attorney fees arising out of, directly or indirectly, any claim of personal injury or death associated with such unintended or unauthorized use, even if such claim alleges that SCILLC was negligent regarding the design or manufacture of the part. SCILLC is an Equal Opportunity/Affirmative Action Employer. This literature is subject to all applicable copyright laws and is not for resale in any manner.

PUBLICATION ORDERING INFORMATION

LITERATURE FULFILLMENT:
Literature Distribution Center for ON Semiconductor
P.O. Box 5163, Denver, Colorado 80217 USA
Phone: 303-675-2175 or 800-344-3860 Toll Free USA/Canada
Fax: 303-675-2176 or 800-344-3867 Toll Free USA/Canada
Email: orderlit@onsemi.com

N. American Technical Support: 800-282-9855 Toll Free
USA/Canada
Europe, Middle East and Africa Technical Support:
Phone: 421 33 790 2910
Japan Customer Focus Center
Phone: 81-3-5773-3850

ON Semiconductor Website: www.onsemi.com

Order Literature: <http://www.onsemi.com/orderlit>

For additional information, please contact your local Sales Representative