

RoHS Compliant Product

A suffix of "-C" specifies halogen & lead-free

FEATURES

- Fast Switching Speed
- Surface Mount Package Ideally Suited for Automatic Insertion
- For General Purpose Switching Applications
- High Conductance

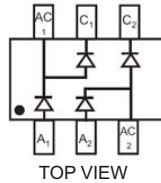
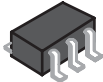

SOT-363

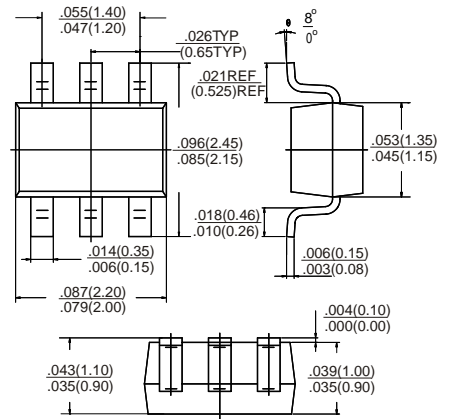

Dimensions in inches and (millimeters)

MAXIMUM RATINGS (EACH DIODE)

Rating	Symbol	Value	Unit
Reverse Voltage	V_R	75	Vdc
Forward Current	I_F	150	mAdc
Peak Forward Surge Current	$I_{FM}(\text{surge})$	400	mAdc

THERMAL CHARACTERISTICS

Characteristic	Symbol	Max	Unit
Total Device Dissipation FR-5 Board ⁽¹⁾ $T_A = 25^\circ\text{C}$ Derate above 25°C	P_D	200 1.8	mW mW/ $^\circ\text{C}$
Thermal Resistance, Junction to Ambient	$R_{\theta JA}$	556	$^\circ\text{C}/\text{W}$
Total Device Dissipation Alumina Substrate, ⁽²⁾ $T_A = 25^\circ\text{C}$ Derate above 25°C	P_D	250 2.4	mW mW/ $^\circ\text{C}$
Thermal Resistance, Junction to Ambient	$R_{\theta JA}$	417	$^\circ\text{C}/\text{W}$
Junction and Storage Temperature	T_J, T_{stg}	-55 to +150	$^\circ\text{C}$

DEVICE MARKING

BAV99BRW= KGJ

ELECTRICAL CHARACTERISTICS ($T_A = 25^\circ\text{C}$ unless otherwise noted) (EACH DIODE)

Characteristic	Symbol	Min	Max	Unit
----------------	--------	-----	-----	------

OFF CHARACTERISTICS

Reverse Breakdown Voltage ($I_{(BR)} = 100 \mu\text{Adc}$)	$V_{(BR)}$	75	—	Vdc
Reverse Voltage Leakage Current ($V_R = 25 \text{ Vdc}, T_J = 150^\circ\text{C}$) ($V_R = 70 \text{ Vdc}$) ($V_R = 70 \text{ Vdc}, T_J = 150^\circ\text{C}$)	I_R	— — —	30 2.5 50	μAdc
Diode Capacitance ($V_R = 0, f = 1.0 \text{ MHz}$)	C_D	—	2	pF
Forward Voltage ($I_F = 1.0 \text{ mAdc}$) ($I_F = 10 \text{ mAdc}$) ($I_F = 50 \text{ mAdc}$) ($I_F = 150 \text{ mAdc}$)	V_F	— — — —	715 855 1000 1250	mVdc
Reverse Recovery Time ($I_F = I_R = 10 \text{ mAdc}, I_{R(REC)} = 1.0 \text{ mAdc}$) (Figure 1) $R_L = 100 \Omega$	t_{rr}	—	4.0	ns

1. FR-5 = 1.0 X 0.75 X 0.062 in. 2. Alumina = 0.4 X 0.3 X 0.024 in. 99.5% alumina.

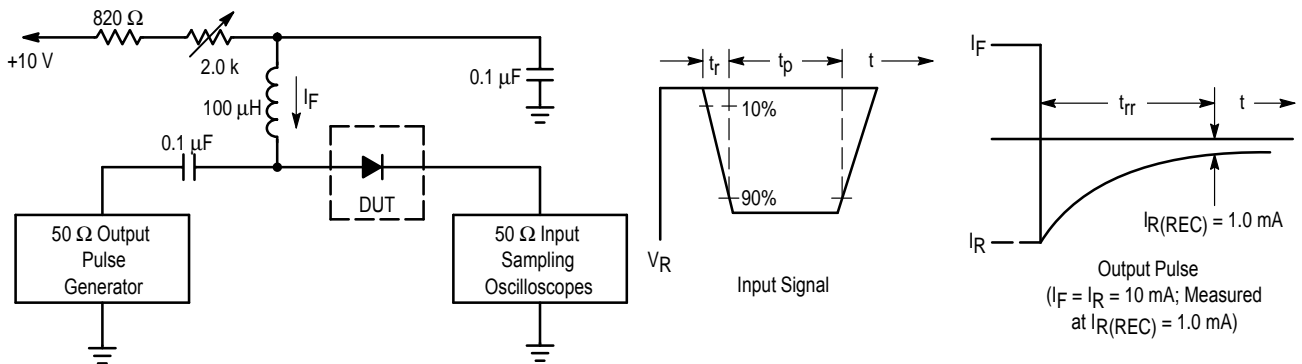

- Notes: 1. A 2.0 kΩ variable resistor adjusted for a Forward Current (I_F) of 10 mA.
2. Input pulse is adjusted so $I_{R(peak)}$ is equal to 10 mA.
3. $t_p \gg t_{rr}$

Figure 1. Recovery Time Equivalent Test Circuit

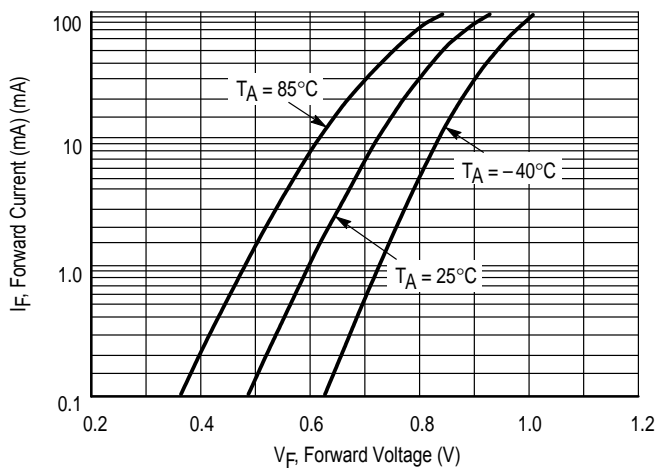

Figure 2. Forward Voltage

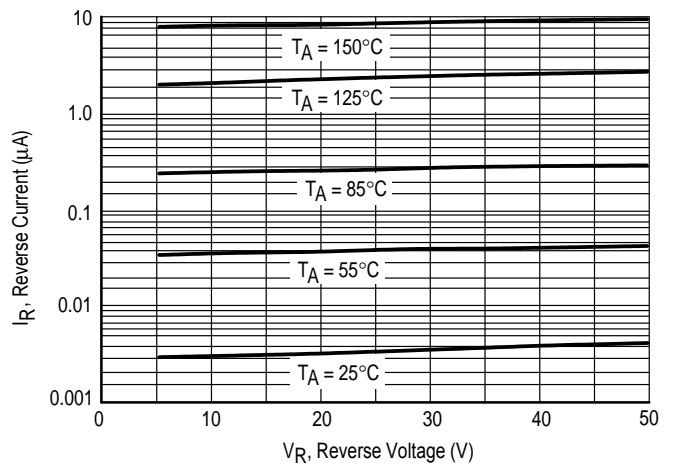

Figure 3. Leakage Current

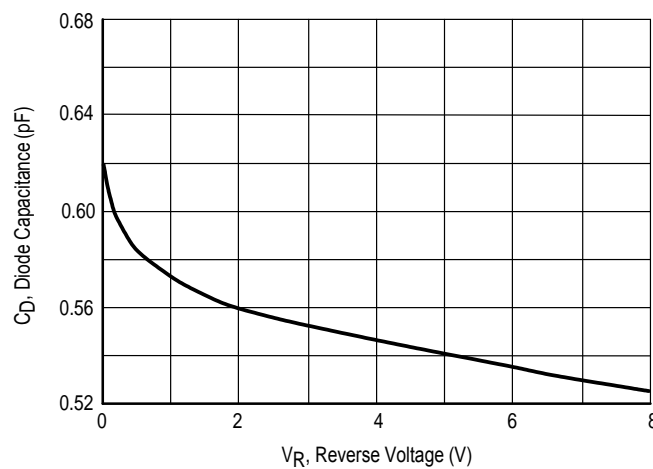

Figure 4. Capacitance