

Specification

Acrich2 – Bulb

8.7W

SMJE-3V08W2P4

SSC		Customer
Drawn	Approval	Approval

Acrich2 - 8.7W Bulb



Description

Acrich 2 series designed for AC drive(or operation) doesn't need the converter which is essential for conventional general lighting. Also, its high power factor can show best energy saving effect in many lighting applications.

As there is no need of converter, Acrich 2 series can realize as close life-time as original LED and make a better use of a space in many applications.

* The appearance and specifications of the product can be changed for improvement without notice.

Acrich2

Features

- Connect using a AIC directly to AC power
- High Power Efficiency
- High Power Factor
- Low THD
- Long Life Time
- Simplest BOM
- Miniaturization
- Lead Free product
- RoHS compliant

Applications

- Bulb light
- Down light

[Contents]

- 1. Characteristics of 8.7W Bulb**
- 2. Outline dimension**
- 3. Color spectrum**
- 4. Power characteristic**
- 5. Color & Binning**
- 6. Circuit Drawing**
- 7. Usage precautions**
- 8. Handling of silicone resin for LEDs**
- 9. Handling with regards to static electricity**
- 10. Storage before use**
- 11. Guidelines for Acrich module work**

1. Characteristics of 8.7W Bulb

1-1-1. Electro-Optical characteristics of SMJE-3V08W2P4 – 2700K

Parameter	Symbol	Value			Unit
		Min	Typ	Max	
Luminous Flux ^[1]	Φ_V ^[2]	610	670		lm
Correlated Color Temperature ^[3]	CCT		2700		K
CRI	R_a	80	-	-	-
Operating Voltage ^[4]	V_{opt}	220			V[RMS]
Power Dissipation	P_D		8.7		W
Operating Frequency	Freq	50 / 60			Hz
Power Factor	PF	Over 0.97			-
View Angle	2θ 1/2	120			deg.

1-1-2. Electro-Optical characteristics of SMJE-3V08W2P4 – 3000K

Parameter	Symbol	Value			Unit
		Min	Typ	Max	
Luminous Flux ^[1]	Φ_V ^[2]	620	670		lm
Correlated Color Temperature ^[3]	CCT		3000		K
CRI	R_a	80	-	-	-
Operating Voltage ^[4]	V_{opt}	220			V[RMS]
Power Dissipation	P_D		8.7		W
Operating Frequency	Freq	50 / 60			Hz
Power Factor	PF	Over 0.97			-
View Angle	2θ 1/2	120			deg.

1-1-3. Electro-Optical characteristics of SMJE-3V08W2P4 – 5000K

Parameter	Symbol	Value			Unit
		Min	Typ	Max	
Luminous Flux [1]	Φ_v [2]	640	690		lm
Correlated Color Temperature [3]	CCT		5000		K
CRI	R_a	80	-	-	-
Operating Voltage [4]	V_{opt}	220			V[RMS]
Power Dissipation	P_D		8.7		W
Operating Frequency	Freq	50 / 60			Hz
Power Factor	PF	Over 0.97			-
View Angle	2 θ 1/2	120			deg.

1-2 Absolute Maximum Ratings of 8.7W Bulb

Parameter	Symbol	Value	Unit
Max. Voltage	V_{opt}	264	V[RMS]
Power Dissipation	P_d	11.5	W
Operating Temperature	T_{opr}	-30 ~ 85	°C
Storage Temperature	T_{stg}	-40 ~ 100	°C
ESD Sensitivity	-	±4,000V HBM	-

* Notes :

[1] At 220V RMS, $T_a=25^\circ\text{C}$

Acrich 2 series maintain the tolerance of $\pm 10\%$ on flux and power measurements.

[2] Φ_v is the total luminous flux output measured with an integrated sphere.

[3] Correlated Color Temperature is derived from the CIE 1931 Chromaticity diagram.

[4] 'Operating Voltage' doesn't indicate the maximum voltage which customers use but means tolerable voltage according to each country's voltage variation rate.
It is recommended that the solder pad temperature should be below 70°C .

2. Outline Dimension

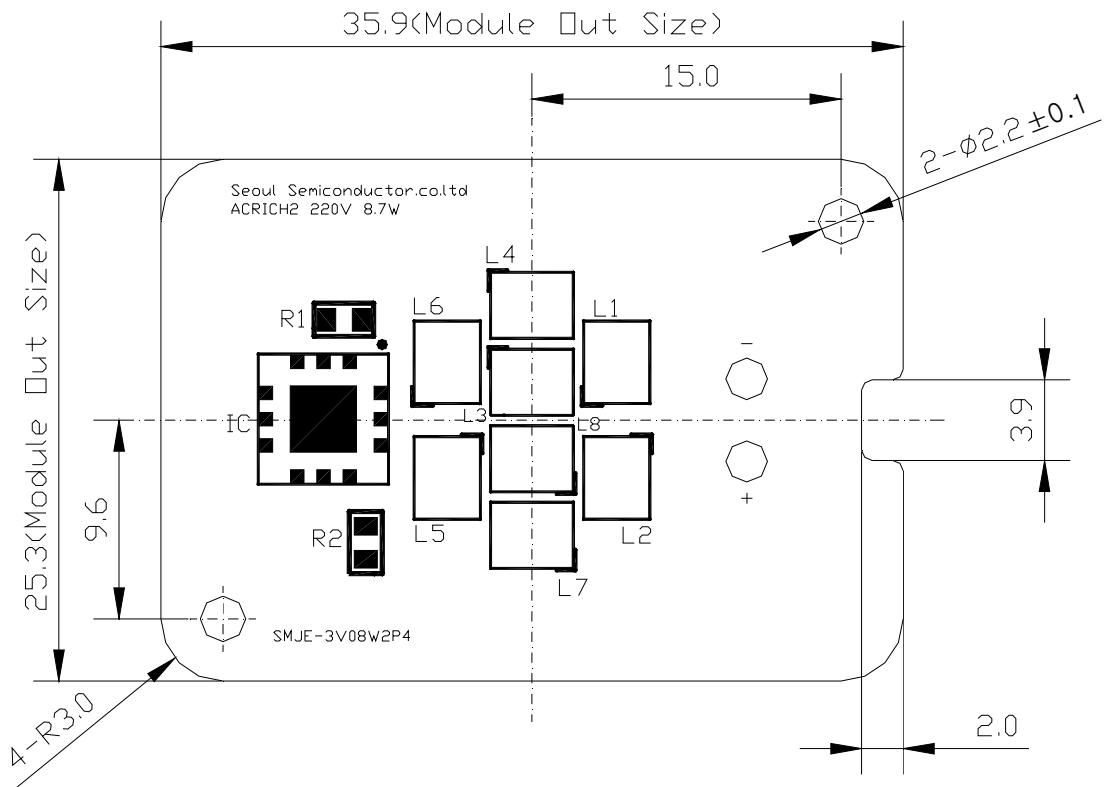

* Notes :

- [1] All dimensions are in millimeters.
- [2] Scale : none

3. Color spectrum

Relative Spectral Power Distribution at Ta=25°C 2,700K, 3,000K

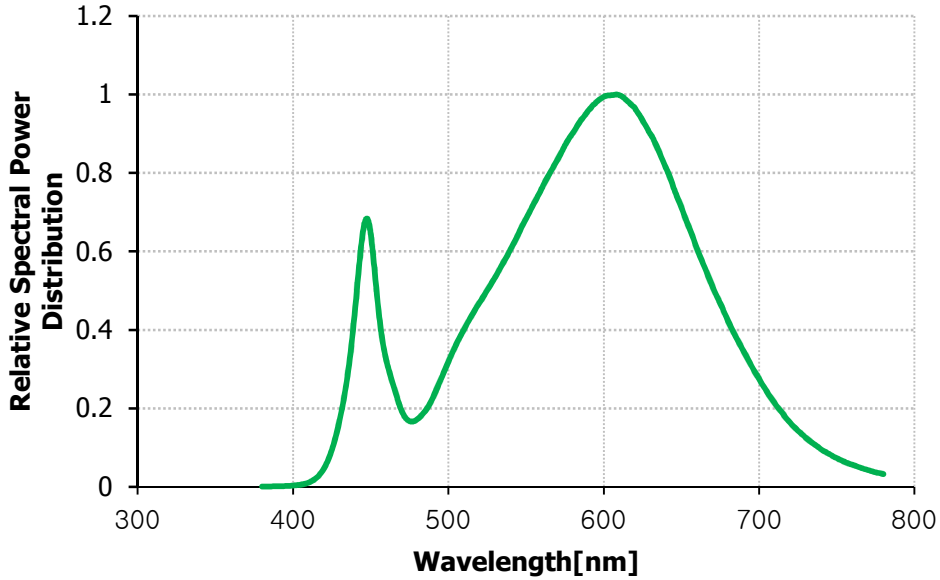

Relative Spectral Power Distribution at Ta=25°C 5,000K

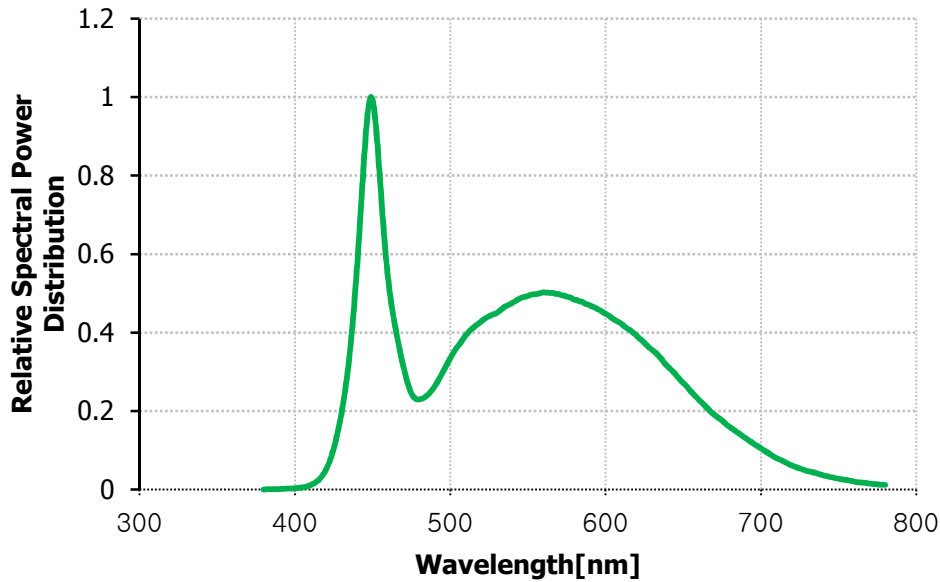

4. Power characteristic

Relative Power Distribution vs. Voltage at Ta=25°C

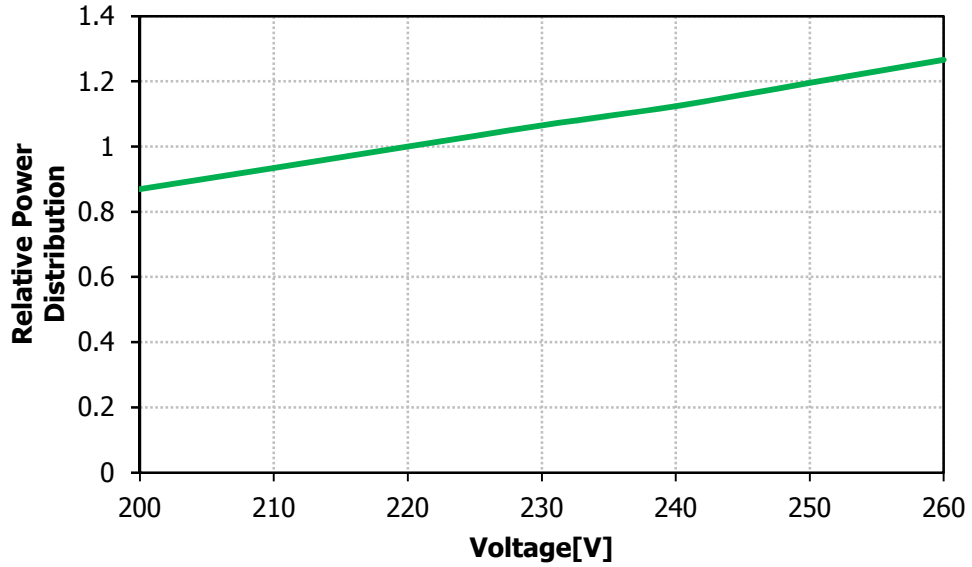

Relative Luminous flux vs. Forward Voltage, Ta=25°C

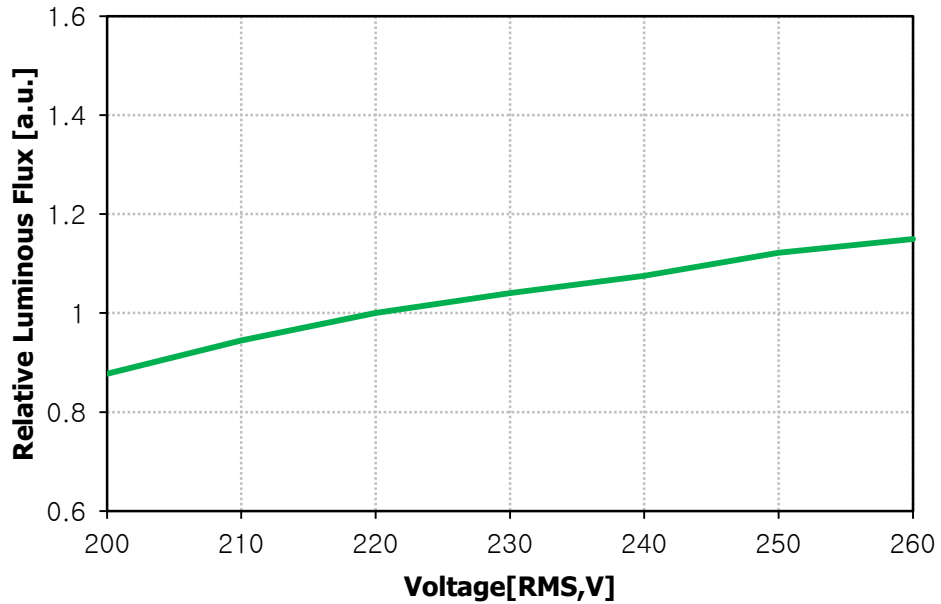

5. Color & Binning

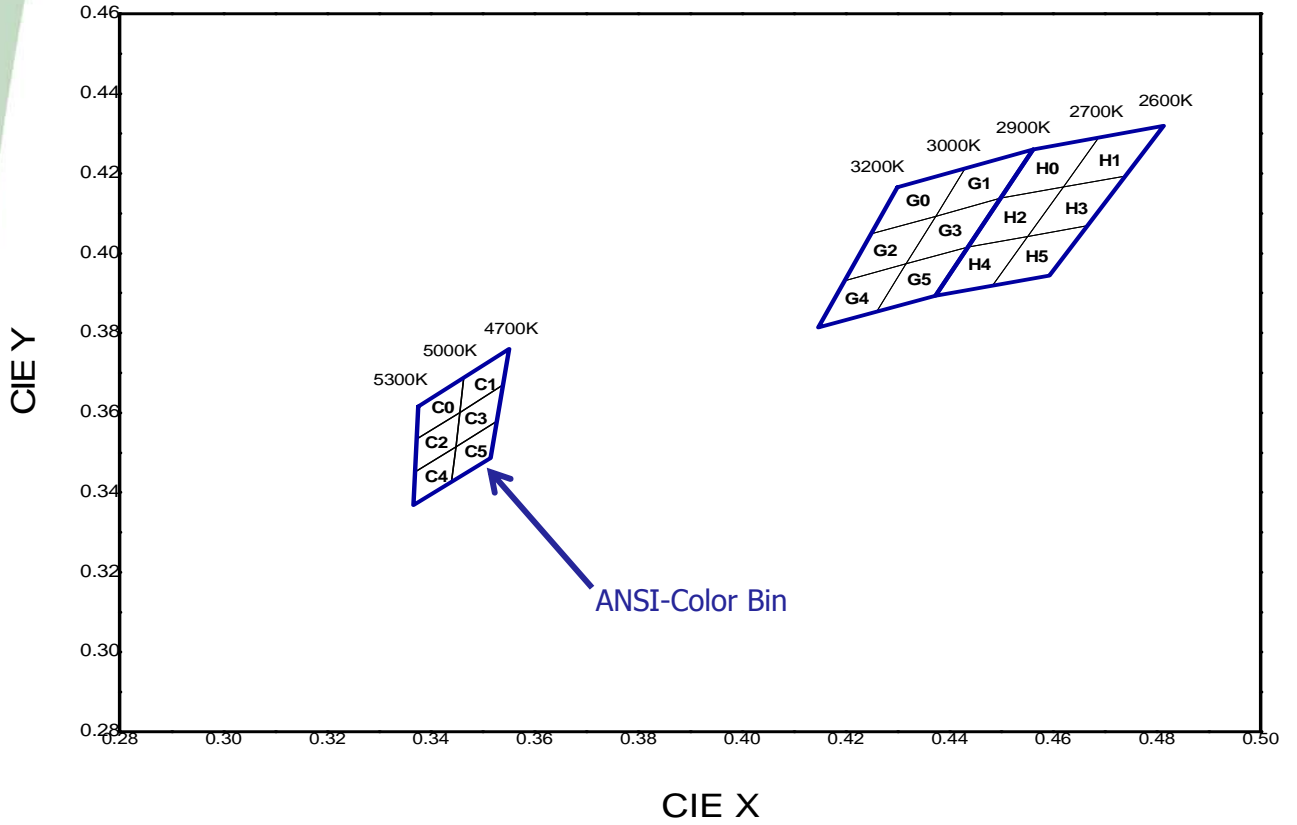

▷ COLOR RANK

Rank	Bin	CIE X	CIE Y	Bin	CIE X	CIE Y	Bin	CIE X	CIE Y						
C	C0	X1	0.3376	Y1	0.3616	C1	X1	0.3463	Y1	0.3687	C2	X1	0.3373	Y1	0.3534
		X2	0.3373	Y2	0.3534		X2	0.3456	Y2	0.3601		X2	0.3369	Y2	0.3451
		X3	0.3456	Y3	0.3601		X3	0.3539	Y3	0.3669		X3	0.3448	Y3	0.3514
		X4	0.3463	Y4	0.3687		X4	0.3552	Y4	0.3760		X4	0.3456	Y4	0.3601
	C3	X1	0.3456	Y1	0.3601	C4	X1	0.3369	Y1	0.3451	C5	X1	0.3448	Y1	0.3514
		X2	0.3448	Y2	0.3514		X2	0.3366	Y2	0.3369		X2	0.3440	Y2	0.3428
		X3	0.3526	Y3	0.3578		X3	0.3440	Y3	0.3428		X3	0.3514	Y3	0.3487
		X4	0.3539	Y4	0.3669		X4	0.3448	Y4	0.3514		X4	0.3526	Y4	0.3578

Rank	Bin	CIE X		CIE Y		Bin	CIE X		CIE Y		Bin	CIE X		CIE Y	
G	G0	X1	0.4299	Y1	0.4165	G1	X1	0.4430	Y1	0.4212	G2	X1	0.4248	Y1	0.4048
		X2	0.4248	Y2	0.4048		X2	0.4374	Y2	0.4093		X2	0.4198	Y2	0.3931
		X3	0.4374	Y3	0.4093		X3	0.4499	Y3	0.4138		X3	0.4317	Y3	0.3973
		X4	0.4430	Y4	0.4212		X4	0.4562	Y4	0.4260		X4	0.4374	Y4	0.4093
	G3	CIE X		CIE Y		G4	CIE X		CIE Y		G5	CIE X		CIE Y	
		X1	0.4374	Y1	0.4093		X1	0.4198	Y1	0.3931		X1	0.4317	Y1	0.3973
		X2	0.4317	Y2	0.3973		X2	0.4147	Y2	0.3814		X2	0.4259	Y2	0.3853
		X3	0.4436	Y3	0.4015		X3	0.4259	Y3	0.3853		X3	0.4373	Y3	0.3893
	X4	0.4499	Y4	0.4138	X4	0.4317	Y4	0.3973	X4	0.4436	Y4	0.4015			

Rank	Bin	CIE X		CIE Y		Bin	CIE X		CIE Y		Bin	CIE X		CIE Y	
H	H0	X1	0.4562	Y1	0.4260	H1	X1	0.4687	Y1	0.4289	H2	X1	0.4499	Y1	0.4138
		X2	0.4499	Y2	0.4138		X2	0.4620	Y2	0.4166		X2	0.4436	Y2	0.4015
		X3	0.4620	Y3	0.4166		X3	0.4740	Y3	0.4194		X3	0.4551	Y3	0.4042
		X4	0.4687	Y4	0.4289		X4	0.4810	Y4	0.4319		X4	0.4620	Y4	0.4166
	H3	CIE X		CIE Y		H4	CIE X		CIE Y		H5	CIE X		CIE Y	
		X1	0.4620	Y1	0.4166		X1	0.4436	Y1	0.4015		X1	0.4551	Y1	0.4042
		X2	0.4551	Y2	0.4042		X2	0.4373	Y2	0.3893		X2	0.4483	Y2	0.3919
		X3	0.4666	Y3	0.4069		X3	0.4483	Y3	0.3919		X3	0.4593	Y3	0.3944
	X4	0.4740	Y4	0.4194	X4	0.4551	Y4	0.4042	X4	0.4666	Y4	0.4069			

* Measurement Uncertainty of the Color Coordinates : ± 0.01

6. Circuit Drawing

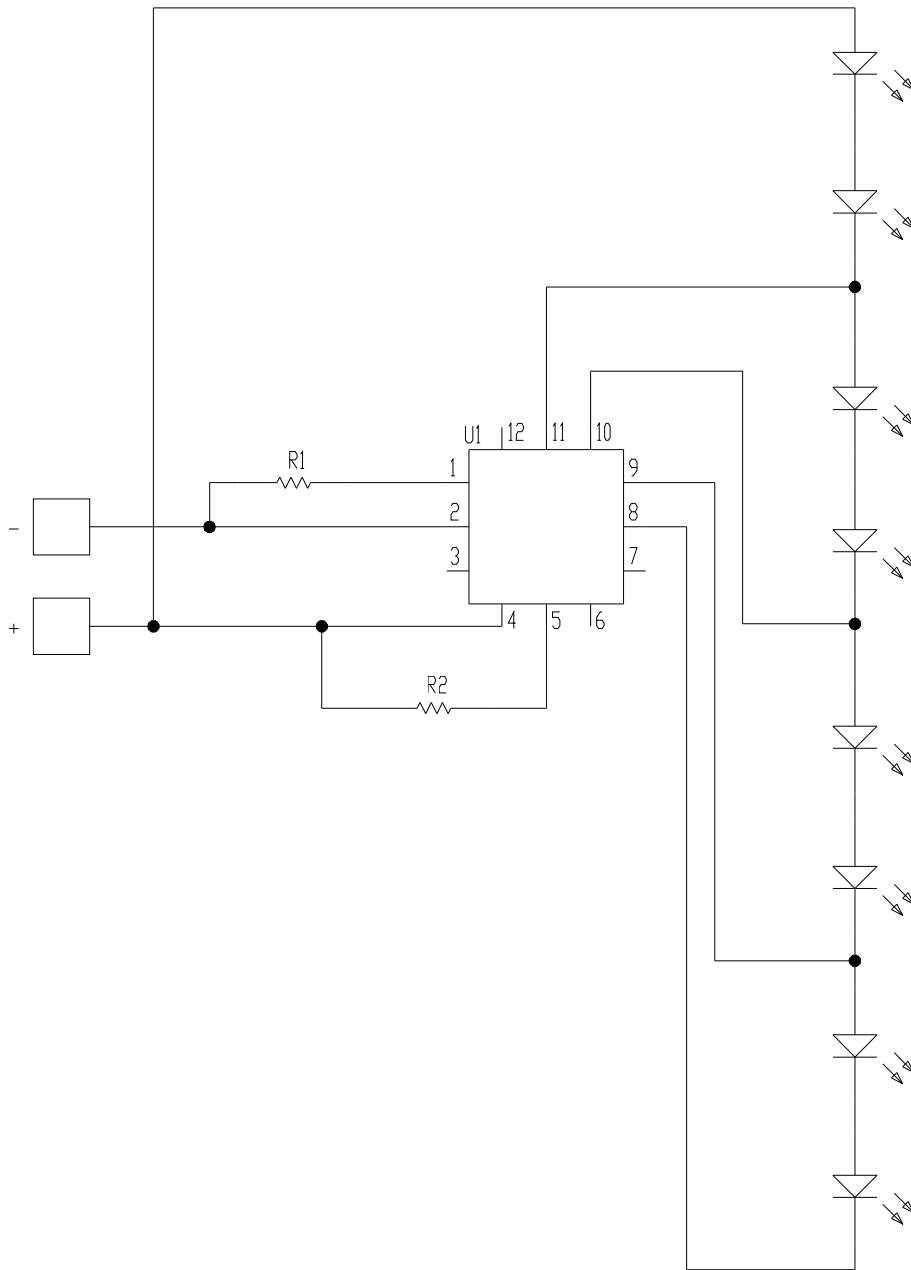

7. Usage precautions

- Please review the Acrich2 Module Application Note for protective circuitry component usage.
- Please note, the Acrich products run on high voltage so use caution when near the the device which the circuit is active.
- DO NOT touch any of the circuit board, components or terminals with body or metal while circuit is active.
- Please do not add or change wires while Acrich circuit is active
- Long time exposure of sunlight or occasional UV exposure will cause lens discoloration.
- Please do not use adhesives to attach the LED that outgas organic vapor.
- Please do not use together with the materials containing Sulfur
- Please do not assemble under the condition of moisture and oxidizing gas in the air(Cl, H₂S,NH₃,SO₂,NOX,etc)

8. Handling of silicone resin for LEDs

- Acrich series is encapsulated with silicone resin for high optical efficiency.
- Please do not touch the silicone resin area with sharp objects such as pincette(tweezers).
- Finger prints on silicone resin area may affect the performance.
- Please store LEDs in covered containers as it is dust sensitive.
- Excessive force more than 3000gf to the silicone lens can result in fatal or permanent damage with LEDs.
- Please do not cover the silicone resin area with any other resins such as epoxy, urethane, etc.

9. Handling with regards to static electricity

- The Acrich2 modules use an integrated circuit (IC) which can be damaged when exposed to static electricity. Please handle using equipment that prevents static electricity. Do not touch unless ESD protection is used.
- The Acrich2 modules should also not be installed in end equipment with out ESD protection.

10. Storage before use

- Do not impact or place pressure on this product because even a small amount of pressure can damage the product. The product should also not be placed in high temperatures, high humidity or direct sunlight since the device is sensitive to these conditions.

(1) Please, confirm the lists below, when storing it in a long term.

- * It should be stored in the anti-static bag that Seoul-Semiconductor packed without opening it.
- * If you opened it in order to prevent humidity, you should seal it and not let the air and humidity into the bag.

11. Guidelines for Acrich module work

- Discharge the lighting system minimum 2~3 times prior to starting work.
- Use only the tested instruments, and insulated tools rated for the voltage and current specified.
- Wear rubber made gloves and rubber bottom shoes or sneakers.
- Do not wear any conductive items (such as jewelry) which could accidentally contact electric circuits.
- Perform several tests with power off and the lighting system unplugged.
- Faults, lightning, or switching transients can cause voltage surges in excess of the normal ratings.
- Internal component failure can cause excessive voltages.
- Stored or residual electricity in long wire could be hazardous. Make sure proper discharge prior to starting work.